

High/low-side, bidirectional, zero-drift current sense amplifiers

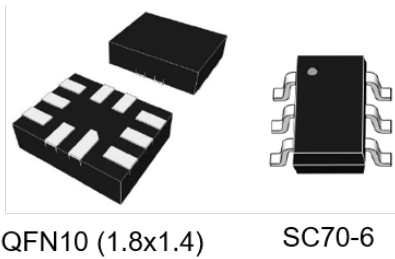

Features

- Wide common mode voltage: -0.3 to 26 V
- Offset voltage: $\pm 35 \mu\text{V}$ max. (TSC210)
- 2.7 to 26 V supply voltage
- Different gain available
 - TSC210 (200 V/V)
 - TSC211 (500 V/V)
 - TSC212 (1000 V/V)
 - TSC213 (50 V/V)
 - TSC214 (100 V/V)
 - TSC215 (75 V/V)
- Gain error: $\pm 1\%$ max.
- Offset drift: $0.1 \mu\text{V}/^\circ\text{C}$ max.
- Gain drift: $20 \text{ ppm}/^\circ\text{C}$ max.
- Quiescent current: $100 \mu\text{A}$
- QFN10 (1.8x1.4) and SC70-6

Applications

- Telecom equipment
- Power management
- Notebook computers
- Industrial applications
- Battery chargers

Product status link

TSC210, TSC211, TSC212, TSC213,
TSC214 and TSC215

Description

The TSC210, TSC211, TSC212, TSC213, TSC214 and TSC215 are a series of zero-drift current sense amplifiers that can sense current via a shunt resistor over a wide range of common mode voltages from -0.3 to +26 V, whatever the supply voltage is. They are available in three different versions, each of them having a different gain. The TSC21x are designed with a specific zero-drift architecture, which can achieve high precision.

The TSC21x are current sense amplifiers that may be used in various functions such as precision current measurement, over current protection, current monitoring, feedback loops.

These devices fully operate over the broad supply voltage range of 2.7 to 26 V and over the industrial temperature range -40 to 125 °C.

1 Pin connections and description

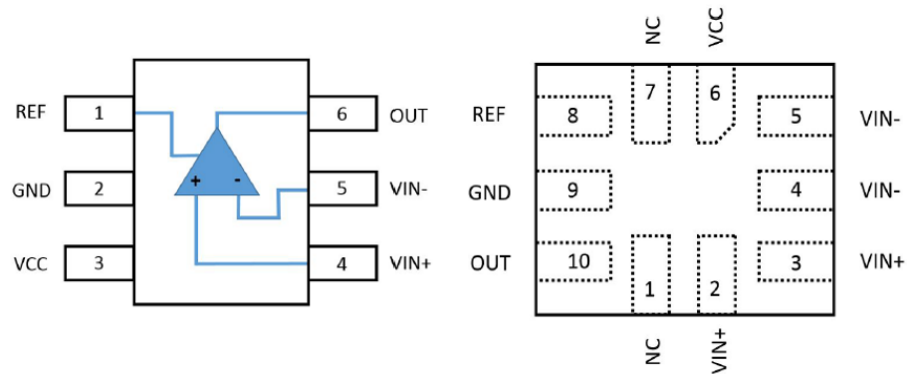
Figure 1. Pin connections (top view)

Table 1. Pin description

Name	SC70-6	QFN10	Description
REF	1	8	Reference voltage input
GND	2	9	Ground
Vcc	3	6	Power supply voltage
Vin+	4	2, 3	Connection to the external sense resistor
Vin-	5	4, 5	Connection to the external sense resistor
OUT	6	10	Output voltage
NC		1, 7	Not connected ⁽¹⁾

1. Pins can be left floating or connected to VCC or GND.

2 Block diagram

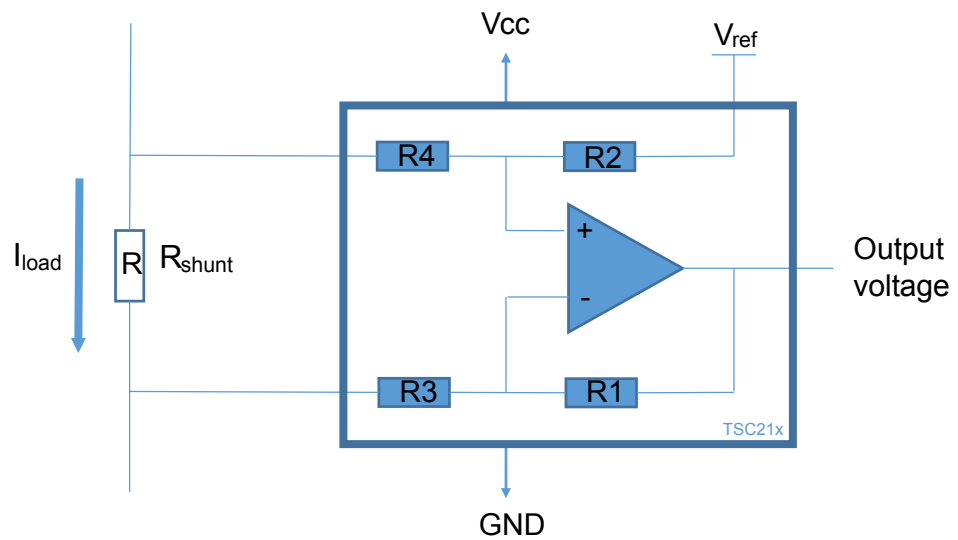
Figure 2. Block diagram



$$\text{Output voltage} = (R_{\text{shunt}} \times I_{\text{load}}) \times \text{Gain} + V_{\text{ref}}$$

Table 2. Resistors and gain values

Product	R1 and R2	R3 and R4	Gain
TSC210	1 MΩ	5 kΩ	200
TSC211	1 MΩ	2 kΩ	500
TSC212	1 MΩ	1 kΩ	1000
TSC213	1 MΩ	20 kΩ	50
TSC214	1 MΩ	10 kΩ	100
TSC215	1 MΩ	13.3 kΩ	75

3 Absolute maximum ratings and operating conditions

Table 3. Absolute maximum ratings

Symbol	Parameter	Value	Unit
V_{CC}	Supply voltage ⁽¹⁾	26	V
V_{IN}	Differential voltage between input pins (In+, In-)	-26 to +26	V
	Common mode voltage on input pins	Gnd-0.3 to 26	
Ref	Reference input voltage	Gnd-0.3 to $V_{CC}+0.3$	V
I_{in}	Input current to any pin ⁽²⁾	5	mA
V_{out}	Output voltage	Gnd-0.3 to $V_{CC}+0.3$	V
T_{Lead}	Lead temperature for 10 s ⁽³⁾	260	°C
T_{stg}	Storage temperature	-65 to 150	°C
T_j	Junction temperature	150	°C
R_{th-ja}	Thermal resistance junction to ambient ⁽⁴⁾⁽⁵⁾		°C/W
	QFN10	124	
	SC70-6	232	
ESD	HBM: human body model ⁽⁶⁾	4000	V
	CDM: charged device model ⁽⁷⁾	1000	

1. All voltage values, except the differential voltage are with respect to the network ground terminal.
2. Due to AMR on input current (I_{in}), differential voltage may be limited.
3. Reflow at peak temperature of 260 °C. Time above 255 °C must not exceed 30 s.
4. Short-circuits can cause excessive heating and destructive dissipation.
5. R_{th} are typical values.
6. According to JEDEC standard JESD22-A114F.
7. According to ANSI/ESD STM5.3.1.

Table 4. Operating conditions

Symbol	Parameter	Value	Unit
V_{CC}	Supply voltage	2.7 to 26	V
V_{icm}	Common mode voltage on input pins	-0.3 to +26	V
T	Operating free-air temperature range	-40 to 125	°C

4 Electrical characteristics

Table 5. Electrical characteristics, T = 25 °C, $V_{SENSE} = V_{IN+} - V_{IN-}$ (unless otherwise specified), TSC210, TSC213, TSC214, TSC215: $V_{CC} = 5\text{ V}$, $V_{IN+} = 12\text{ V}$, $V_{REF} = V_{CC}/2$ (unless otherwise specified), TSC211, TSC212: $V_{CC} = 12\text{ V}$, $V_{IN+} = 12\text{ V}$, $V_{REF} = V_{CC}/2$ (unless otherwise specified)

Symbol	Parameter	Conditions	Min.	Typ.	Max.	Unit
Power supply						
V_{CC}	Supply voltage		2.7		26	V
I_{CC}	Quiescent current	$V_{SENSE} = 0\text{ mV}$		65	100	μA
		$T_{min.} < T < T_{max.}$			115	
Input						
V_O	Offset voltage (RTI) ⁽¹⁾					μV
	TSC210, TSC211, TSC212	$V_{SENSE} = 0\text{ mV}$	-35		35	
	TSC214, TSC215	$V_{SENSE} = 0\text{ mV}$	-60		60	
	TSC213	$V_{SENSE} = 0\text{ mV}$	-100		100	
$ \Delta V_O/\Delta T $	Offset voltage variation (RTI) vs. temperature	$V_{SENSE} = 0\text{ mV}$, $T_{min.} < T < T_{max.}$		0.05	0.3	$\mu\text{V}/^\circ\text{C}$
CMRR	Common mode rejection ratio					dB
	TSC210, TSC211, TSC212	$V_{IN+} = 0\text{ to }26\text{ V}$, $V_{SENSE} = 0\text{ mV}$, $T_{min.} < T < T_{max.}$	105	140		
	TSC213, TSC214, TSC215	$V_{in+} = 0\text{ to }26\text{ V}$, $V_{SENSE} = 0\text{ mV}$, $T_{min.} < T < T_{max.}$	100	120		
PSRR	Power supply rejection ratio	$V_{CC} = 2.7\text{ to }26\text{ V}$ $V_{IN+} = 18\text{ V}$, $V_{SENSE} = 0\text{ mV}$		0.1	10	$\mu\text{V}/\text{V}$
I_{IB}	Input bias current	$V_{SENSE} = 0\text{ mV}$	15	28	35	μA
I_{IO}	Input offset current	$V_{SENSE} = 0\text{ mV}$		0.02		
Output						
G	Gain	TSC210		200		V/V
		TSC211		500		
		TSC212		1000		
		TSC213		50		
		TSC214		100		
		TSC215		75		
E_G	Gain error	$V_{SENSE} = -5\text{ to }+5\text{ mV}$ $T_{min.} < T < T_{max.}$		0.02	± 1	%
T_G	Gain error vs. temperature	$T_{min.} < T < T_{max.}$		7	20	ppm/ $^\circ\text{C}$
NLE	Linearity error	$V_{SENSE} = -5\text{ to }+5\text{ mV}$		0.01		%

Symbol	Parameter	Conditions	Min.	Typ.	Max.	Unit
C_L	Maximum capacitive load	No sustained oscillation		470		pF
V_{sw+}	Output swing close to V_{CC}	$R_L=10\text{ k}\Omega$ to Gnd $T_{min.} < T < T_{max.}$	$V_{CC}-0.2$	$V_{CC}-0.05$		V
V_{sw-}	Output swing close to Gnd	$R_L=10\text{ k}\Omega$ to Gnd $T_{min.} < T < T_{max.}$		5	30	mV
R_{Load}	Load regulation	$I_{OUT} = -10$ to $+10$ mA		0.5		Ω
Dynamic performance						
BW	Bandwidth	$V_{CC} = 5\text{ V}$, $V_{icm} = 12\text{ V}$, $C_I = 100\text{ pF}$				kHz
		TSC210		25		
		TSC211		8		
		TSC212		6		
		TSC213		100		
		TSC214		40		
		TSC215		60		
SR	Slew rate	$V_{CC} = 5\text{ V}$, $V_{icm} = 12\text{ V}$, $C_I = 100\text{ pF}$				V/ μ s
		TSC210		0.2		
		TSC211		0.075		
		TSC212		0.05		
		TSC213		0.85		
		TSC214		0.32		
		TSC215		0.42		
E_N	Noise (RTI) ⁽¹⁾	$f = 1\text{ kHz}$				nV/ $\sqrt{\text{Hz}}$
		TSC210		40		
		TSC211		48		
		TSC212		50		
		TSC213		38		
		TSC214		40		
		TSC215		39		

1. RTI stands for "related to input"

5 Typical characteristics

The TSC210 is used for typical characteristics, unless otherwise specified

Figure 3. Input offset voltage production distribution

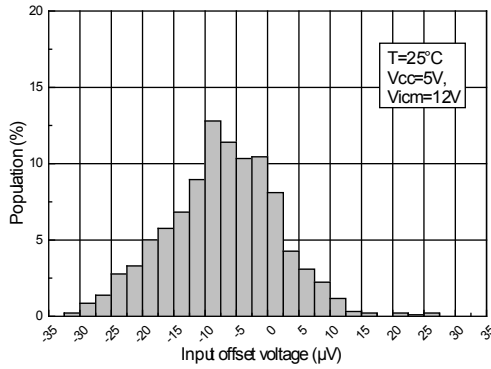

Figure 4. Input offset voltage vs temperature

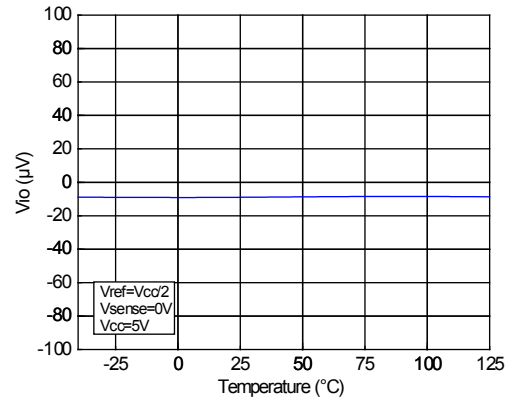

Figure 5. Common-mode rejection ratio production distribution

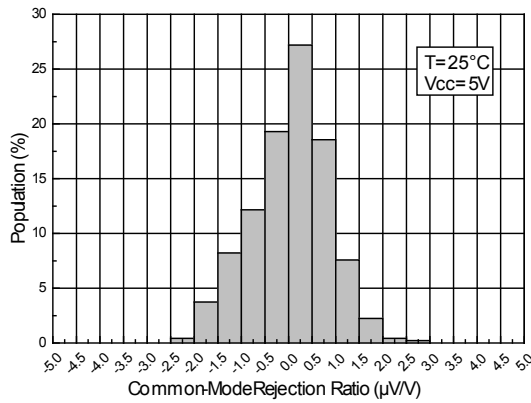

Figure 6. Common mode rejection ratio vs temperature

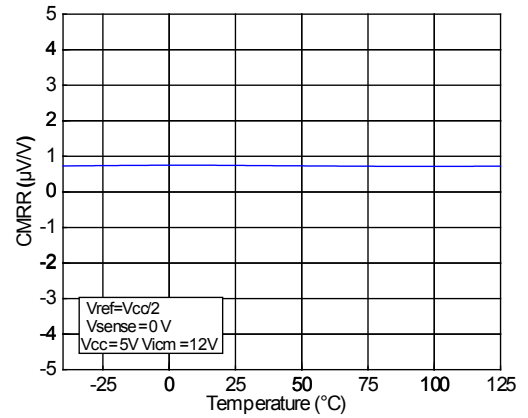

Figure 7. Gain vs frequency

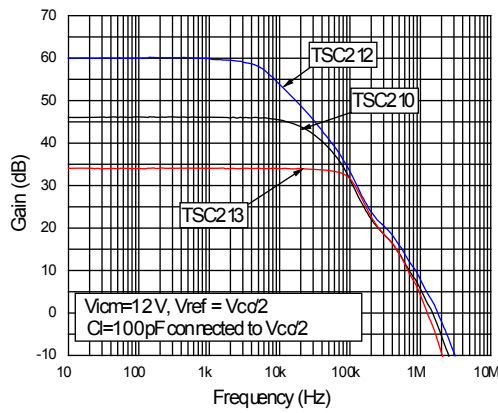

Figure 8. Power supply rejection ratio vs frequency

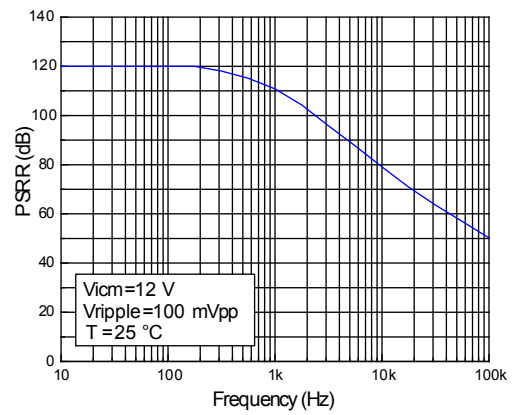

Figure 9. Common mode rejection ratio vs frequency

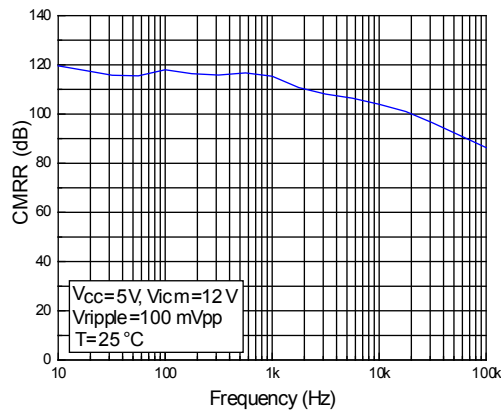

Figure 10. Positive output voltage swing vs output current V_{CC} = 2.7 V

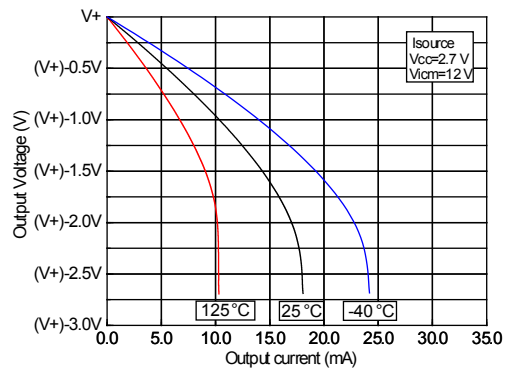

Figure 11. Negative output voltage swing vs output current V_{CC} = 2.7 V

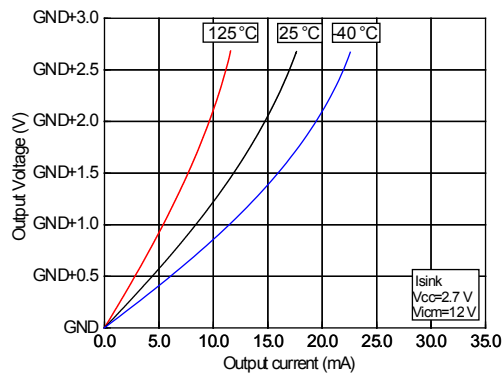

Figure 12. Positive output voltage swing vs output current V_{CC} = 5 V

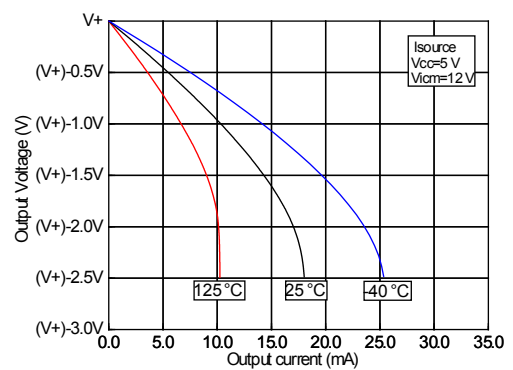

Figure 13. Negative output voltage swing vs output current $V_{CC} = 5\text{ V}$

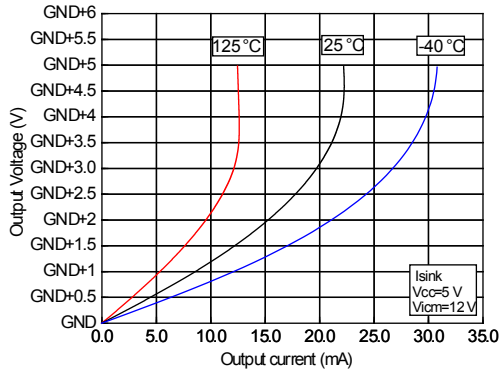

Figure 14. Positive output voltage swing vs output current $V_{CC} = 26\text{ V}$

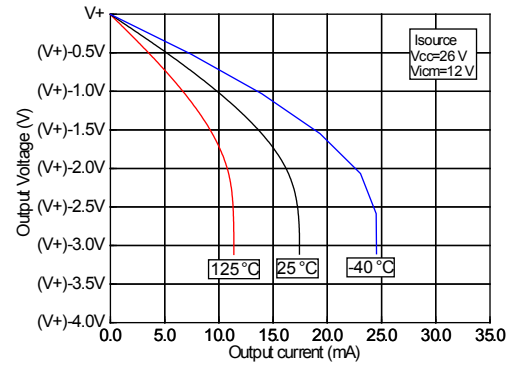

Figure 15. Negative output voltage swing vs output current $V_{CC} = 26\text{ V}$

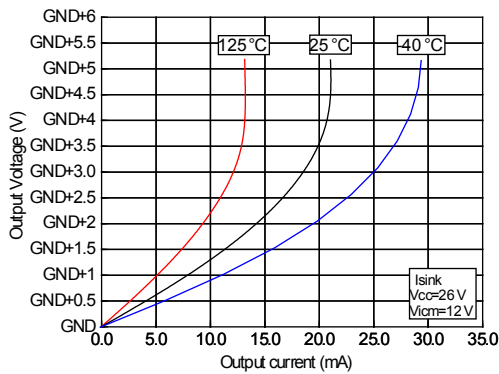

Figure 16. Input bias current vs input common mode voltage with supply voltage = 5 V

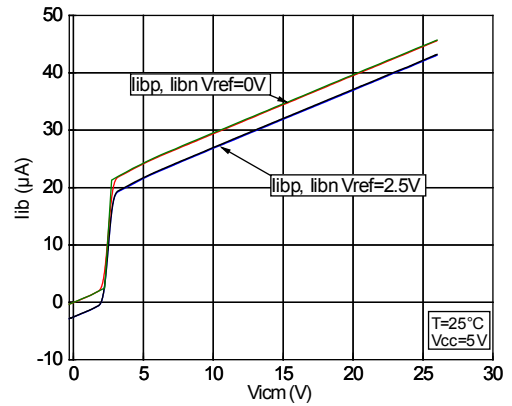

Figure 17. Input bias current vs input common mode voltage with supply voltage = 0 V

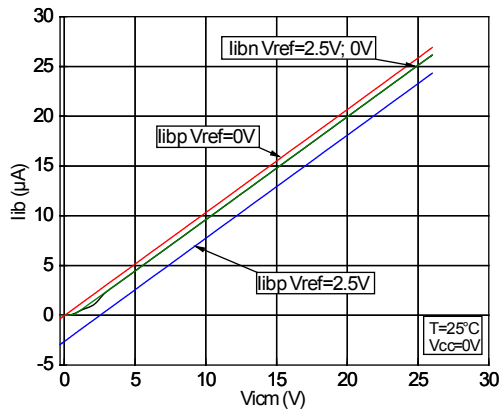

Figure 18. Input bias current vs temperature

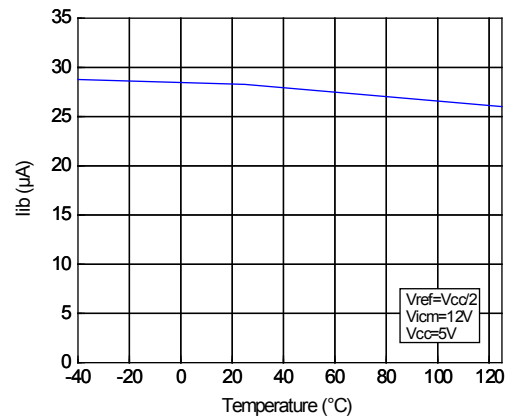

Figure 19. Quiescent current vs temperature

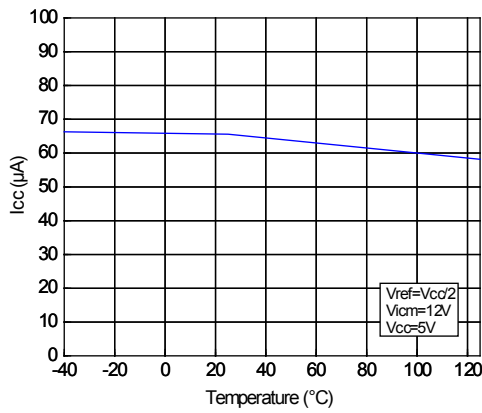

Figure 20. Input referred noise vs frequency

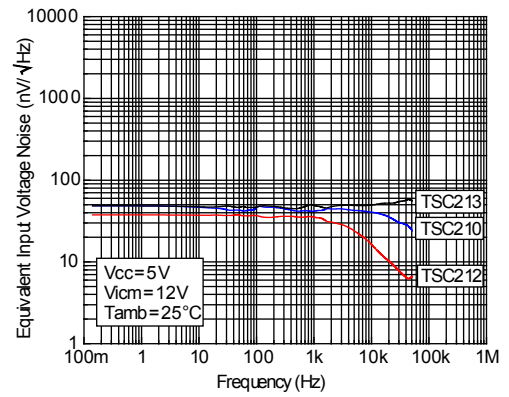

Figure 21. 0.1 Hz to 10 Hz voltage noise (referred to input)

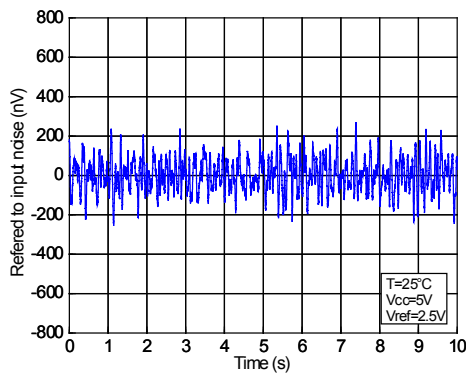

Figure 22. Step response (10-mVpp input step)

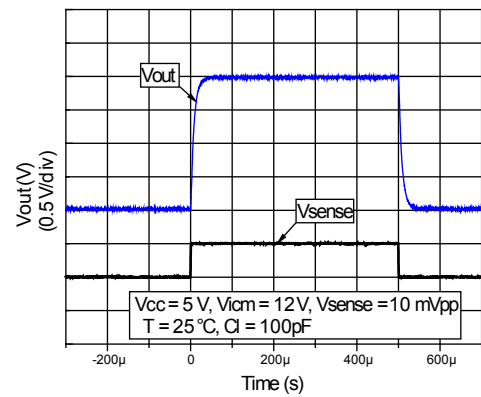

Figure 23. Common mode voltage transient response

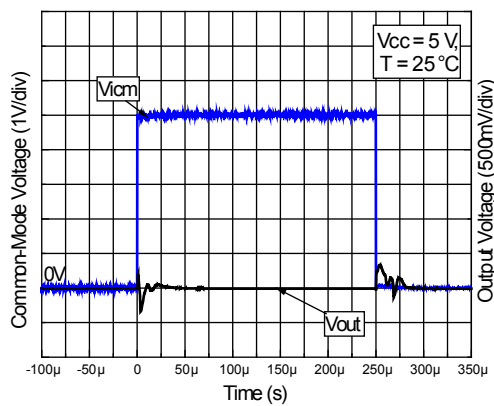

Figure 24. Inverting differential input overloaded

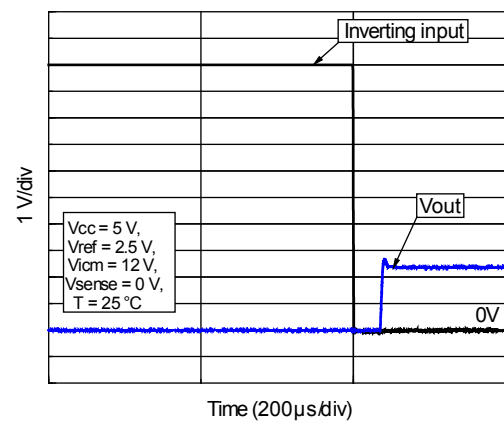

Figure 25. Non inverting differential input overload

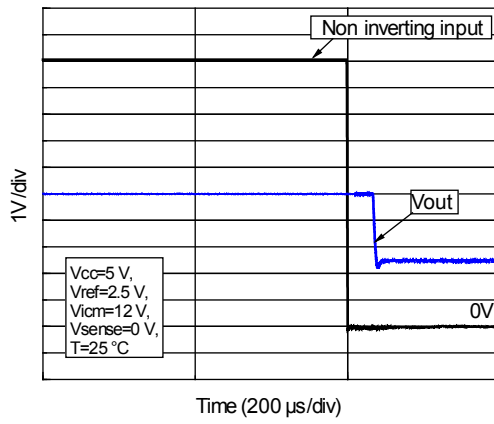

Figure 26. Start-up response

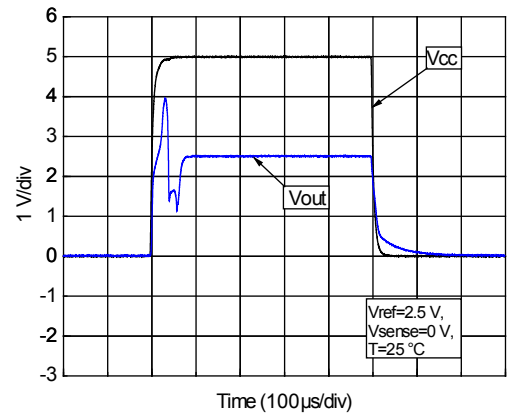
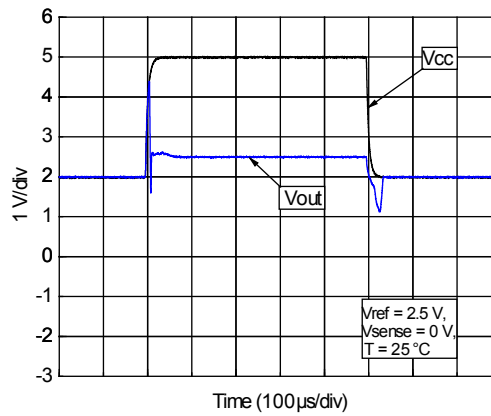

Figure 27. Brownout recovery



6 Package information

In order to meet environmental requirements, ST offers these devices in different grades of **ECOPACK** packages, depending on their level of environmental compliance. ECOPACK specifications, grade definitions and product status are available at: www.st.com. ECOPACK is an ST trademark.

6.1 SC70-6 package information

Figure 28. SC70-6 package outline

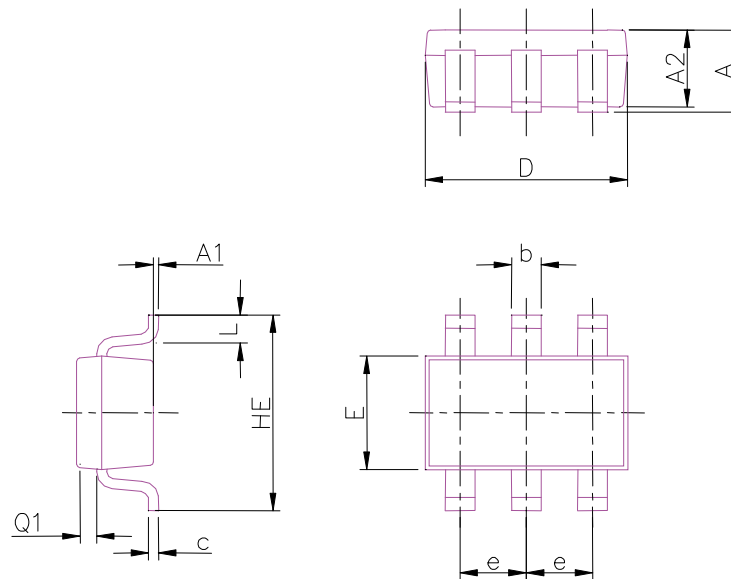
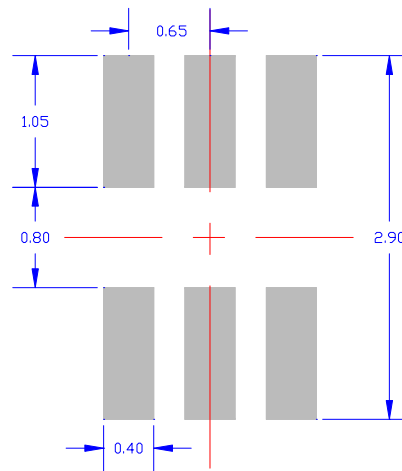

Table 6. SC70-6 mechanical data

Symbol	Millimeters			Inches ⁽¹⁾		
	Min.	Typ.	Max.	Min.	Typ.	Max.
A	0.80		1.10	0.037		0.041
A1	0		0.10	0.000		0.004
A2	0.80		1.00	0.035		0.039
b	0.15		0.30	0.008		0.010
c	0.10		0.18	0.004		0.004
D	1.80		2.20	0.078		0.086
E	1.15		1.35	0.050		0.052
e		0.65		0.025		0.026
HE	1.8		2.4	0.083		0.090
L	0.10		0.40	0.013		0.015
Q1	0.10		0.40	0.011		0.013

1. Values in inches are converted from mm and rounded to 4 decimal digits.

Figure 29. SC70-6 recommended footprint



6.2 QFN10 package information

Figure 30. QFN10 package outline

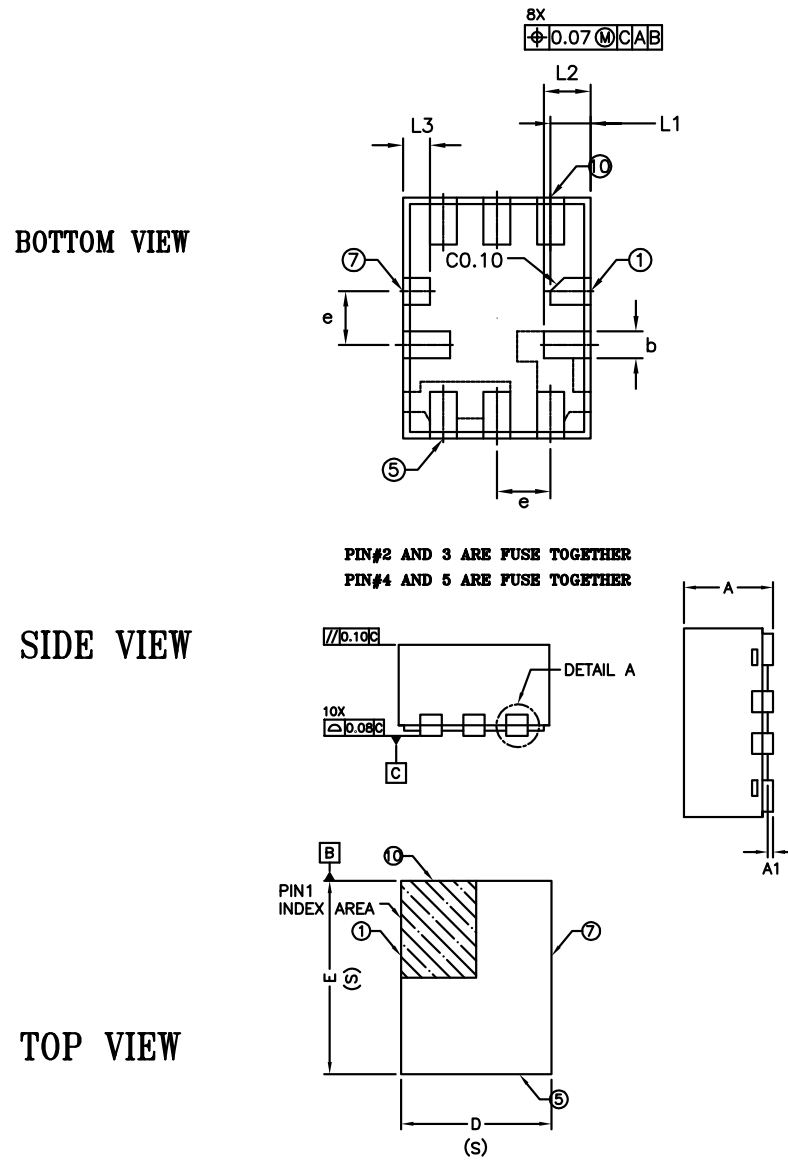

Figure 31. QFN10 detail A package outline

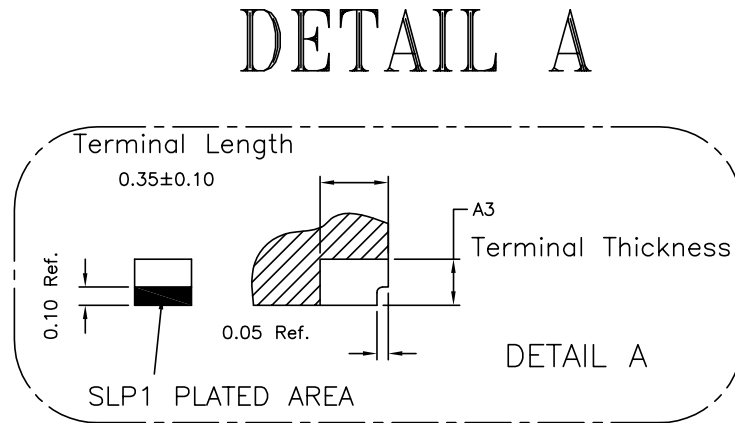
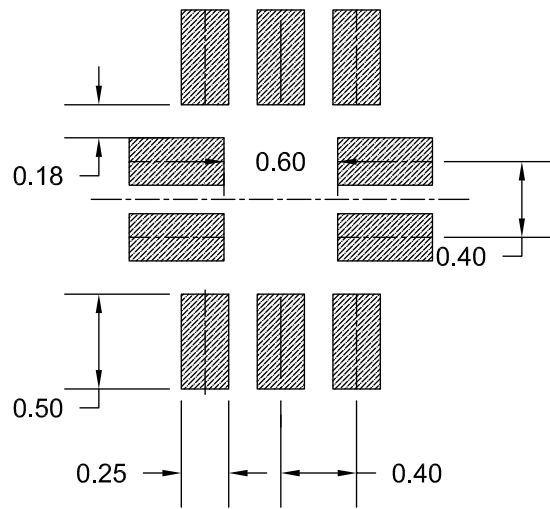

Table 7. QFN10 mechanical data

Symbol	mm		
	Min.	Typ.	Max.
A	0.70	0.75	0.80
A1	0.0		0.05
A3	0.203REF		
b	0.15	0.20	0.25
D	1.35	1.40	1.45
e	0.40 BSC		
E	1.75	1.80	1.85
L1	0.20	0.30	0.40
L2	0.25	0.35	0.45
L3	0.10	0.20	0.30

Figure 32. QFN10 recommended footprint



7 Ordering information

Table 8. Ordering information

Order code	Gain (V/V)	Temperature range	Package	Packing	Marking
TSC210ICT	200	-40°C to 125°C	SC70-6	Tape and reel	O10
TSC210IYCT ⁽¹⁾					O16
TSC210IQT			QFN10		O10
TSC210IYQT ⁽¹⁾					O16
TSC211ICT	500		SC70-6		O11
TSC211IYCT ⁽¹⁾					O17
TSC211IQT			QFN10		O11
TSC211IYQT ⁽¹⁾					O17
TSC212ICT	1000		SC70-6		O12
TSC212IYCT ⁽¹⁾					O18
TSC212IQT			QFN10		O12
TSC212IYQT ⁽¹⁾					O18
TSC213ICT	50		SC70-6		O13
TSC213IYCT ⁽¹⁾					O19
TSC213IQT			QFN10		O13
TSC213IYQT ⁽¹⁾					O19
TSC214ICT	100		SC70-6		O14
TSC214IYCT ⁽¹⁾					O1A
TSC214IQT			QFN10		O14
TSC214IYQT ⁽¹⁾					O1A
TSC215ICT	75	SC70-6	O15		
TSC215IYCT ⁽¹⁾			O1B		
TSC215IQT		QFN10	O15		
TSC215IYQT ⁽¹⁾			O1B		

1. Qualified and characterized according to the AEC Q100 and Q003 or equivalent, advanced screening according to the AEC Q001 and Q002 or equivalent.

Revision history

Table 9. Document revision history

Date	Version	Changes
13-Feb-2020	1	Initial release.
27-Feb-2020	2	Update features in cover page and Section 4 Electrical characteristics.
24-Nov-2020	3	Added the part numbers: TSC211, TSC214 and TSC215. Updated cover page. Updated Table 2. Resistors and gain values, Section 4 Electrical characteristics and Section 7 Ordering information.
29-Mar-2021	4	Updated Table 3. Absolute maximum ratings and Section 4 Electrical characteristics.

Contents

1	Pin connections and description	2
2	Block diagram	3
3	Absolute maximum ratings and operating conditions	4
4	Electrical characteristics	5
5	Typical characteristics	7
6	Package information	12
6.1	SC70-6 package information	12
6.2	QFN10 package information	14
7	Ordering information	17
	Revision history	18

List of tables

Table 1.	Pin description.	2
Table 2.	Resistors and gain values	3
Table 3.	Absolute maximum ratings	4
Table 4.	Operating conditions	4
Table 5.	Electrical characteristics, $T = 25\text{ }^{\circ}\text{C}$, $V_{\text{SENSE}} = V_{\text{IN}+} - V_{\text{IN}-}$ (unless otherwise specified), TSC210, TSC213, TSC214, TSC215: $V_{\text{CC}} = 5\text{ V}$, $V_{\text{IN}+} = 12\text{ V}$, $V_{\text{REF}} = V_{\text{CC}}/2$ (unless otherwise specified), TSC211, TSC212: $V_{\text{CC}} = 12\text{ V}$, $V_{\text{IN}+} = 12\text{ V}$, $V_{\text{REF}} = V_{\text{CC}}/2$ (unless otherwise specified).	5
Table 6.	SC70-6 mechanical data.	12
Table 7.	QFN10 mechanical data	15
Table 8.	Ordering information.	17
Table 9.	Document revision history	18

List of figures

Figure 1.	Pin connections (top view)	2
Figure 2.	Block diagram	3
Figure 3.	Input offset voltage production distribution	7
Figure 4.	Input offset voltage vs temperature	7
Figure 5.	Common-mode rejection ratio production distribution	7
Figure 6.	Common mode rejection ratio vs temperature.	7
Figure 7.	Gain vs frequency.	8
Figure 8.	Power supply rejection ratio vs frequency.	8
Figure 9.	Common mode rejection ratio vs frequency	8
Figure 10.	Positive output voltage swing vs output current $V_{CC} = 2.7\text{ V}$	8
Figure 11.	Negative output voltage swing vs output current $V_{CC} = 2.7\text{ V}$	8
Figure 12.	Positive output voltage swing vs output current $V_{CC} = 5\text{ V}$	8
Figure 13.	Negative output voltage swing vs output current $V_{CC} = 5\text{ V}$	9
Figure 14.	Positive output voltage swing vs output current $V_{CC} = 26\text{ V}$	9
Figure 15.	Negative output voltage swing vs output current $V_{CC} = 26\text{ V}$	9
Figure 16.	Input bias current vs input common mode voltage with supply voltage = 5 V	9
Figure 17.	Input bias current vs input common mode voltage with supply voltage = 0 V	9
Figure 18.	Input bias current vs temperature	9
Figure 19.	Quiescent current vs temperature	10
Figure 20.	Input referred noise vs frequency	10
Figure 21.	0.1 Hz to 10 Hz voltage noise (referred to input)	10
Figure 22.	Step response (10-mVpp input step)	10
Figure 23.	Common mode voltage transient response.	10
Figure 24.	Inverting differential input overloaded	10
Figure 25.	Non inverting differential input overload	11
Figure 26.	Start-up response	11
Figure 27.	Brownout recovery	11
Figure 28.	SC70-6 package outline.	12
Figure 29.	SC70-6 recommended footprint	13
Figure 30.	QFN10 package outline	14
Figure 31.	QFN10 detail A package outline	15
Figure 32.	QFN10 recommended footprint.	16



IMPORTANT NOTICE – PLEASE READ CAREFULLY

STMicroelectronics NV and its subsidiaries (“ST”) reserve the right to make changes, corrections, enhancements, modifications, and improvements to ST products and/or to this document at any time without notice. Purchasers should obtain the latest relevant information on ST products before placing orders. ST products are sold pursuant to ST’s terms and conditions of sale in place at the time of order acknowledgement.

Purchasers are solely responsible for the choice, selection, and use of ST products and ST assumes no liability for application assistance or the design of Purchasers’ products.

No license, express or implied, to any intellectual property right is granted by ST herein.

Resale of ST products with provisions different from the information set forth herein shall void any warranty granted by ST for such product.

ST and the ST logo are trademarks of ST. For additional information about ST trademarks, please refer to www.st.com/trademarks. All other product or service names are the property of their respective owners.

Information in this document supersedes and replaces information previously supplied in any prior versions of this document.

© 2021 STMicroelectronics – All rights reserved