

## M12 FEMALE 90° LED

PUR 5X0.34 YELLOW, 5m

M12

Female 90°

5-pole with 3 × LED (PNP)

Art.-No. 7005 - M12 Lite - (plastic hexagonal screw) on request

Plastic housings with good resistance against chemicals and oils. The resistance to aggressive media should be individually tested for your application. Further details on request. Further cable lengths on request.

### [Link to Product](#)

#### Illustration

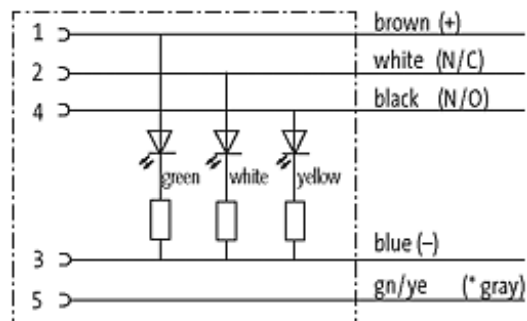
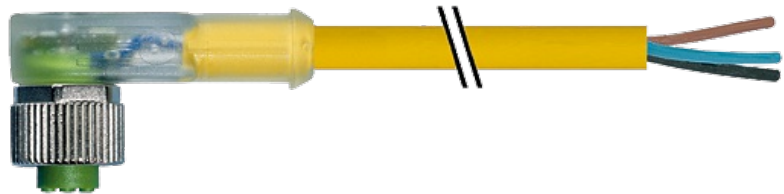

(\* for cable type 126 and 732)

# Female



Product may differ from Image

## Approvals



\* only for products with UL/CSA approved cable

## Form

12441

## Technical Data

Operating voltage	24 V DC $\pm 25\%$
Operating current per contact	max. 4 A
Locking of ports	Screw thread M12 $\times$ 1 mm (recommended torque 0.6 Nm) self-securing
Protection	IP67 inserted and tightened (EN 60529)

## Cables

Cable number	025
--------------	-----

No./diameter of wires	5 × 0.34 mm <sup>2</sup>
Wire isolation	PVC (br, wh, bl, bk, gnye)
C-track properties	2 Mio.
Jacket Color	yellow
Shore hardness outer jacket	85 ± 5A
Material (jacket)	PUR/PVC (UL/CSA)
Outer diameter	approx. 5.9 mm
Bend radius (fixed)	10 × outer Ø
Bend radius (moving)	15 × outer Ø
Temperature range (fixed)	-30...+80 °C
Temperature range (mobile)	-5...+80 °C

#### General data

Temperature range	-25...+85 °C, depending on cable quality
-------------------	--

#### Commercial data

country of origin	DE
customs tariff number	85444290
minimum order quantity	1