

4.0 V to 17 V Input, 3 A Integrated MOSFET Single Synchronous Buck DC/DC Converter

BD9D300MUV

General Description

BD9D300MUV is a synchronous buck switching regulator with built-in low on-resistance power MOSFETs. This integrated circuit (IC) is capable of providing current up to 3 A. It operates high oscillating frequency with low inductance. It has original on-time control system which can operate low power consumption in light load condition. This IC is ideal for reducing standby power consumption of equipment.

Key Specifications

■ Input Voltage Range:	4 V to 17 V
■ Output Voltage Range:	0.9 V to 5.25 V
■ Output Current:	3 A (Max)
■ Switching Frequency:	1.25 MHz (Typ)
■ High-Side FET ON Resistance:	110 mΩ (Typ)
■ Low-Side FET ON Resistance:	50 mΩ (Typ)
■ Shutdown Current:	3 μA (Typ)
■ Operating Quiescent Current:	20 μA (Typ)

Features

- Single Synchronous Buck DC/DC Converter
- On-time Control
- Light Load Mode Control
- Over Current Protection (OCP)
- Short Circuit Protection (SCP)
- Thermal Shutdown Protection (TSD)
- Under Voltage Lockout Protection (UVLO)
- Adjustable Soft Start
- Power Good Output
- Over Voltage Protection (OVP)
- VQFN016V3030 Package Backside Heat Dissipation

Package

VQFN016V3030

W (Typ) x D (Typ) x H (Max)

3.00 mm x 3.00 mm x 1.00 mm

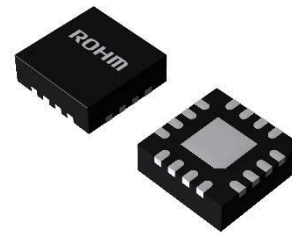

VQFN016V3030

Applications

- Step-down Power Supply for SoC, FPGA, Microprocessor
- Laptop PC / Tablet PC / Server
- LCD TV
- Storage Device (HDD / SSD)
- 2-series Cell Li-Ion Batteries Equipment
- Printer, OA Equipment
- Distributed Power Supply, Secondary Power Supply

Typical Application Circuit

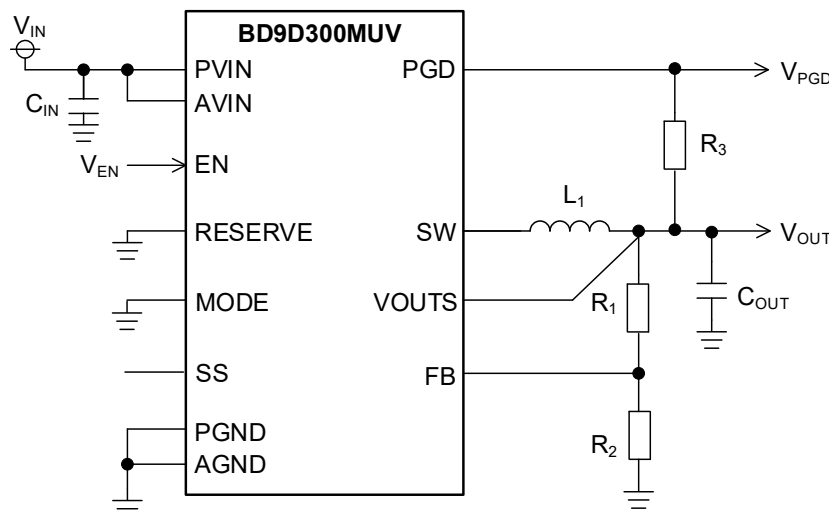

○Product structure : Silicon integrated circuit ○This product has no designed protection against radioactive rays.

Pin Configuration

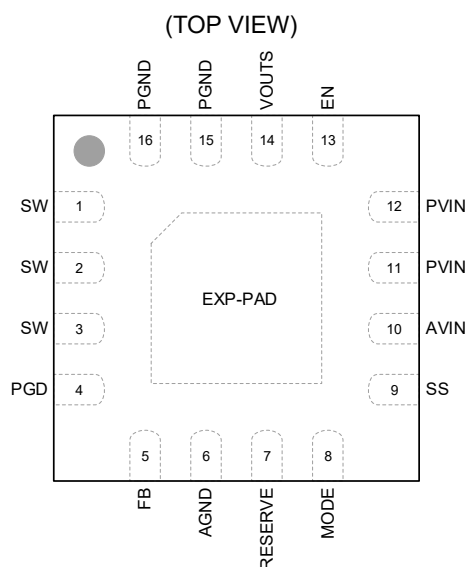

Pin Descriptions

Pin No.	Pin Name	Function
1, 2, 3	SW	Switch pin. These pins are connected to the drain of the High-Side and Low-Side FET. In addition, connect an inductor considering the direct current superimposition characteristic.
4	PGD	Power Good pin. This pin is an open drain output that requires a pull-up resistor (to the VOUTS pin). See page 15 for setting the resistance. If not used, this pin can be left floating or connected to Ground.
5	FB	Output voltage feedback pin. See page 32 for how to calculate the resistances of the output voltage setting.
6	AGND	Ground pin for the control circuit.
7	RESERVE	Reserve pin. Connect to Ground.
8	MODE	Pin for setting switching control mode. Connecting this pin to the VOUTS pin forces the device to operate in the Pulse Width Modulation (PWM) mode control. Connecting to Ground, the mode is automatically switched between the Light Load mode control and PWM mode control. Fix this pin to the VOUTS pin or Ground. Do not change the mode control during operation.
9	SS	Pin for setting the soft start time of output voltage. The soft start time is 1 ms (Typ) when the SS pin is open. A ceramic capacitor connected to the SS pin makes the soft start time 1 ms or more. See page 32 for how to calculate the capacitance.
10	AVIN	Pin for supplying power to the control circuit. Connecting 0.1 μF (Typ) ceramic capacitor is recommended. This pin is connected to PVIN.
11, 12	PVIN	Power supply pins for the output MOSFETs. Connecting 10 μF (Typ) ceramic capacitor is recommended.
13	EN	Enable pin. The device starts up when V_{EN} is set to 0.9 V (Min) or more. The device enters the shutdown mode with setting V_{EN} to 0.3 V (Max) or less. This pin must be properly terminated.
14	VOUTS	Pin for discharging output and detecting output voltage. Connect to output voltage node.
15, 16	PGND	Ground pins for the output stage of the switching regulator.
-	EXP-PAD	A backside heat dissipation pad. Connecting to the internal PCB Ground plane by using via provides excellent heat dissipation characteristics.

Block Diagram

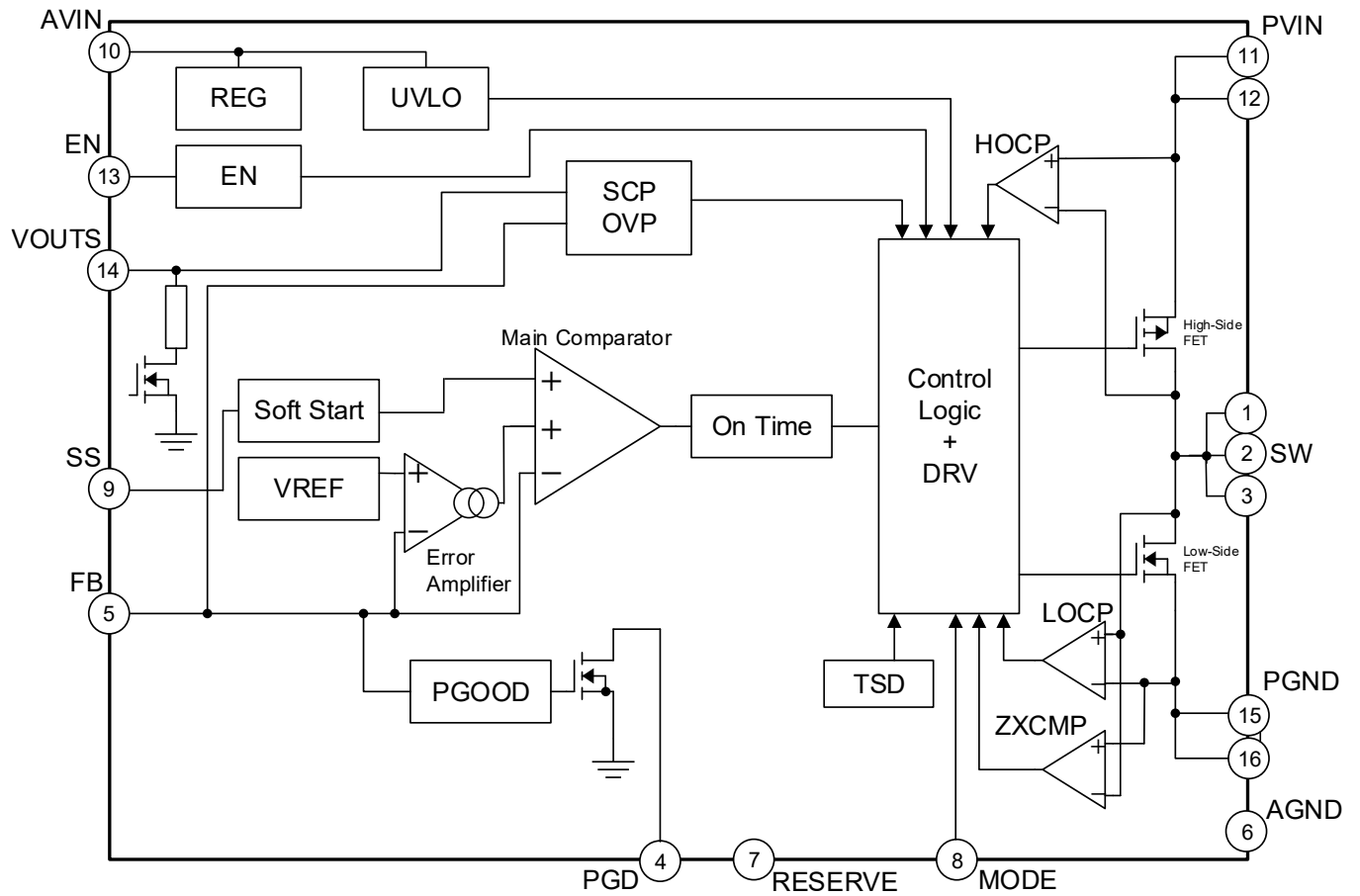

Description of Blocks

1. REG
This block generates the internal power supply.
2. EN
This is the enable block. When EN voltage (V_{EN}) is set to 0.9 V (Min) or more, the internal circuit is activated and the device starts operation. Shutdown is forced if V_{EN} is set to 0.3 V (Max) or less.
3. UVLO
This block is for under voltage lockout protection. The device shuts down when input voltage falls to 3.6 V (Typ) or less. The threshold voltage has a hysteresis of 200 mV (Typ).
4. VREF
This block generates the internal reference voltage.
5. TSD
This block is for thermal protection. The device is shut down when the junction temperature (T_J) reaches to 175 °C (Typ) or more. The device is automatically restored to normal operation with a hysteresis of 25 °C (Typ) when the T_J goes down.
6. Soft Start
This block slows down the rise of output voltage during start-up and controls the current, which allows the prevention of output voltage overshoot and inrush current. The internal soft start time is 1 ms (Typ) when the SS pin is open. A capacitor connected to the SS pin makes the rising time 1 ms or more.
7. PGOOD
This block is for power good function. When the FB voltage (V_{FB}) is more than or equal to 95 % (Typ) of 0.8 V, the built-in open drain Nch MOSFET connected to the PGD pin is off, and the PGD pin becomes High impedance. When V_{FB} is less than or equal to 90 % (Typ) of 0.8 V, it turns on the built-in open drain Nch MOSFET and the PGD pin is pulled down with 100 Ω (Typ).
8. Control Logic + DRV
This block controls switching operation and various protection functions.
9. OVP
This block is for output over voltage protection. When V_{FB} is more than or equal to 120 % (Typ) of 0.8 V, the output MOSFETs are off. After V_{FB} is less than or equal to 115 % (Typ) of 0.8 V, the output MOSFETs are returned to normal operation condition. In addition, when VOUTS voltage (V_{VOUTS}) reaches 5.95 V (Typ) or more, the output MOSFETs are off. After V_{VOUTS} falls 5.65 V (Typ) or less, the output MOSFETs are returned to normal operation condition. If the condition of the over voltage protection is continued for 20 μ s (Typ), the output MOSFETs are latched to off.
10. HOCP
This block is for over current protection of the High-Side FET. When the current that flows through the High-Side FET reaches the value of over current limit, it turns off the High-Side FET and turns on the Low-Side FET.
11. LOCP
This block is for over current protection of the Low-Side FET. While the current that flows through the Low-Side FET over the value of over current limit, the condition that being turned on the Low-Side FET is continued.
12. SCP
This block is for short circuit protection. After soft start is completed and in condition where V_{FB} is less than or equal to 90 % (Typ) of 0.8 V, this block counts the number of times of which current flowing in the High-Side FET or the Low-Side FET reaches over current limit. When 256 times is counted, the device is shut down for 15 ms (Typ) and re-operates. Counting is reset when V_{FB} is more than or equal to 95 % (Typ) of 0.8V, or IC re-operates by EN, UVLO and SCP function.
13. Error Amplifier
The Error Amplifier adjusts Main Comparator input voltage to make the internal reference voltage equal to V_{FB} .
14. Main Comparator
The Main Comparator compares the Error Amplifier output voltage and V_{FB} . When V_{FB} becomes lower than the Error Amplifier output voltage, the output turns High and reports to the On Time block that the output voltage has dropped below the control voltage.
15. On Time
This block generates On Time. The designed On Time is generated after the Main Comparator output turns High. The On Time is adjusted to control the frequency to be fixed even with I/O voltage is changed.
16. ZXCMP
The ZXCMP is a comparator that monitors the inductor current. When inductor current falls below 0 A (Typ) while the Low-Side FET is on, it turns the FET off.

Absolute Maximum Ratings (Ta = 25 °C)

Parameter	Symbol	Rating	Unit
Input Voltage	V _{PVIN} , V _{AVIN}	-0.3 to +20	V
EN Voltage	V _{EN}	-0.3 to V _{PVIN} + 0.3	V
MODE Voltage	V _{MODE}	-0.3 to +7	V
RESERVE Voltage	V _{RESERVE}	-0.3 to +7	V
SS Voltage	V _{SS}	-0.3 to +20	V
PGD Voltage	V _{PGD}	-0.3 to +7	V
FB Voltage	V _{FB}	-0.3 to +7	V
VOU _{TS} Voltage	V _{VOU_{TS}}	-0.3 to +7	V
SW Voltage	V _{SW}	-0.3 to V _{PVIN} + 0.3	V
Output Current	I _{OUT}	3.5	A
Maximum Junction Temperature	T _{Jmax}	150	°C
Storage Temperature Range	T _{stg}	-55 to +150	°C

Caution 1: Operating the IC over the absolute maximum ratings may damage the IC. The damage can either be a short circuit between pins or an open circuit between pins and the internal circuitry. Therefore, it is important to consider circuit protection measures, such as adding a fuse, in case the IC is operated over the absolute maximum ratings.

Caution 2: Should by any chance the maximum junction temperature rating be exceeded the rise in temperature of the chip may result in deterioration of the properties of the chip. In case of exceeding this absolute maximum rating, design a PCB with thermal resistance taken into consideration by increasing board size and copper area so as not to exceed the maximum junction temperature rating.

Thermal Resistance (Note 1)

Parameter	Symbol	Thermal Resistance (Typ)		Unit
		1s (Note 3)	2s2p (Note 4)	
VQFN016V3030				
Junction to Ambient	θ _{JA}	189.0	57.5	°C/W
Junction to Top Characterization Parameter (Note 2)	Ψ _{JT}	23	10	°C/W

(Note 1) Based on JESD51-2A (Still-Air).

(Note 2) The thermal characterization parameter to report the difference between junction temperature and the temperature at the top center of the outside surface of the component package.

(Note 3) Using a PCB board based on JESD51-3.

(Note 4) Using a PCB board based on JESD51-5, 7.

Layer Number of Measurement Board	Material	Board Size
Single	FR-4	114.3 mm x 76.2 mm x 1.57 mmt

Top	
Copper Pattern	Thickness
Footprints and Traces	70 μm

Layer Number of Measurement Board	Material	Board Size	Thermal Via (Note 5)	
			Pitch	Diameter
4 Layers	FR-4	114.3 mm x 76.2 mm x 1.6 mmt	1.20 mm	Φ0.30 mm

Top		2 Internal Layers		Bottom	
Copper Pattern	Thickness	Copper Pattern	Thickness	Copper Pattern	Thickness
Footprints and Traces	70 μm	74.2 mm x 74.2 mm	35 μm	74.2 mm x 74.2 mm	70 μm

(Note 5) This thermal via connects with the copper pattern of all layers.

Recommended Operating Conditions

Parameter	Symbol	Min	Typ	Max	Unit
Input Voltage	V_{PVIN}, V_{AVIN}	4.0	-	17	V
Operating Temperature	T_a	-40	-	+85 (Note 1)	°C
Output Current	I_{OUT}	0	-	3	A
Output Voltage Setting	V_{OUT}	0.9 (Note 2)	-	5.25	V

(Note 1) T_J must be lower than 150°C under actual operating environment. Life time is derated at junction temperature greater than 125 °C.

(Note 2) Use under the condition of the output voltage (V_{OUT}) \geq input voltage (V_{IN}) \times 0.125.

Electrical Characteristics (Unless otherwise specified $T_a = 25$ °C, $V_{PVIN} = V_{AVIN} = 12$ V, $V_{EN} = 5$ V, $V_{MODE} = GND$)

Parameter	Symbol	Min	Typ	Max	Unit	Conditions
Power Supply (AVIN)						
Shutdown Current	I_{SDN}	-	3	10	μ A	$V_{EN} = 0$ V
Operating Quiescent Current	I_{CC}	-	20	40	μ A	$I_{OUT} = 0$ mA No switching
UVLO Detection Threshold Voltage	V_{UVLO}	3.4	3.6	3.8	V	V_{IN} falling
UVLO Hysteresis Voltage	$V_{UVLOHYS}$	-	200	-	mV	
Enable						
EN Input High Level Voltage	V_{ENH}	0.9	-	V_{AVIN}	V	
EN Input Low Level Voltage	V_{ENL}	GND	-	0.3	V	
EN Input Current	I_{EN}	-	-	10	μ A	
Reference Voltage, Error Amplifier, Soft Start						
FB threshold Voltage	V_{FBTH}	0.792	0.800	0.808	V	
FB Input Current	I_{FB}	-	1	100	nA	$V_{FB} = 0.8$ V
Soft Start Charge Current	I_{SS}	2.3	2.5	2.7	μ A	
Internal Soft Start Time	t_{SS}	0.4	1	1.8	ms	
Control						
MODE Input High Level Voltage	V_{MODEH}	0.9	-	V_{VOUTS}	V	
MODE Input Low Level Voltage	V_{MODEL}	GND	-	0.3	V	
On Time	t_{ONT}	-	333	-	ns	$V_{OUT} = 5.0$ V
Power Good						
Power Good Rising Threshold Voltage	V_{PGDR}	92	95	98	%	V_{FB} rising, $V_{PGDR} = V_{FB} / V_{FBTH} \times 100$
Power Good Falling Threshold Voltage	V_{PGDF}	87	90	93	%	V_{FB} falling, $V_{PGDF} = V_{FB} / V_{FBTH} \times 100$
PGD Output Leakage Current	I_{LKPGD}	-	0	800	nA	$V_{PGD} = 5$ V
PGD MOSFET ON Resistance	R_{PGD}	-	100	200	Ω	
PGD Low Level Voltage	V_{PGDL}	-	0.2	0.4	V	$I_{PGD} = 2$ mA
SW (MOSFET)						
High-Side FET ON Resistance	R_{ONH}	-	110	220	m Ω	
Low-Side FET ON Resistance	R_{ONL}	-	50	100	m Ω	
High-Side Output Leakage Current	I_{LKH}	-	0	10	μ A	No switching
Low-Side Output Leakage Current	I_{LKL}	-	0	10	μ A	No switching
Protection						
Output OVP Detection Voltage	V_{OVPH}	115	120	125	%	V_{FB} rising, $V_{OVPH} = V_{FB} / V_{FBTH} \times 100$
Output OVP Release Voltage	V_{OVPL}	110	115	120	%	V_{FB} falling, $V_{OVPL} = V_{FB} / V_{FBTH} \times 100$
Low-Side FET Over Current Detection Current (Note 3)	I_{LOCP}	3.1	3.8	-	A	

(Note 3) No tested on outgoing inspection.

Typical Performance Curves

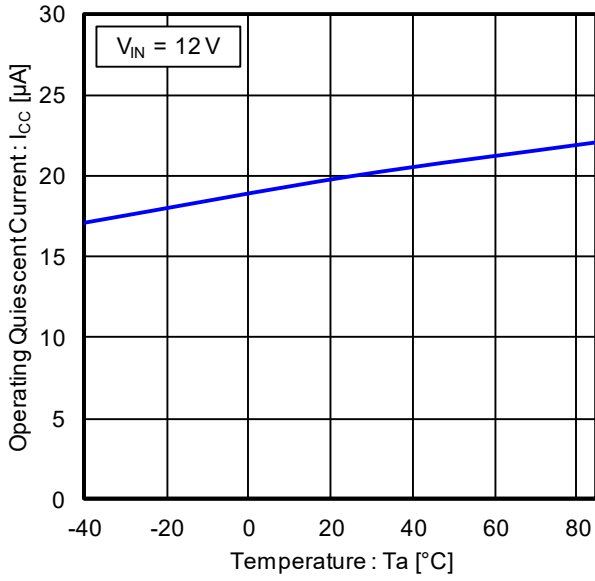

Figure 1. Operating Quiescent Current vs Temperature

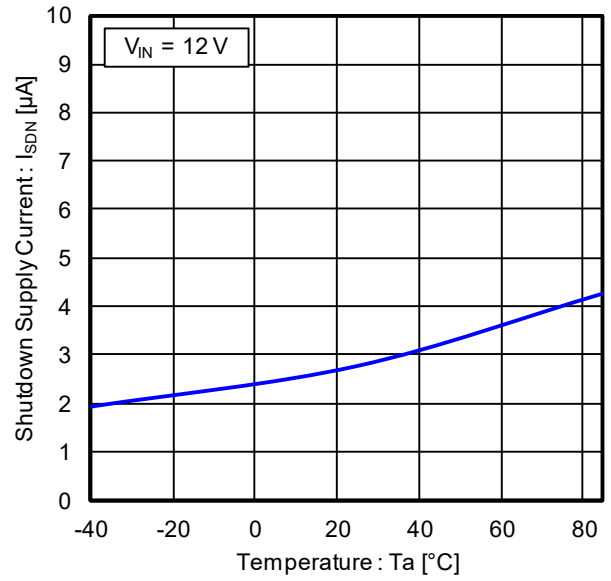

Figure 2. Shutdown Supply Current vs Temperature

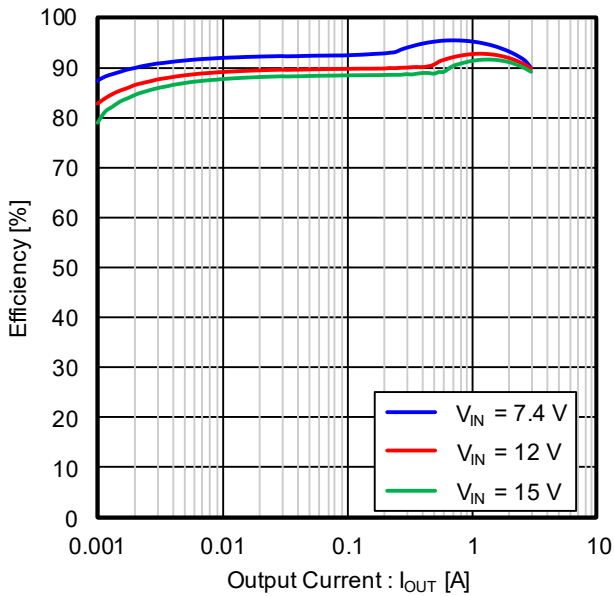

Figure 3. Efficiency vs Output Current (V_{OUT} = 5 V, L = 2.2 µH, MODE = Low)

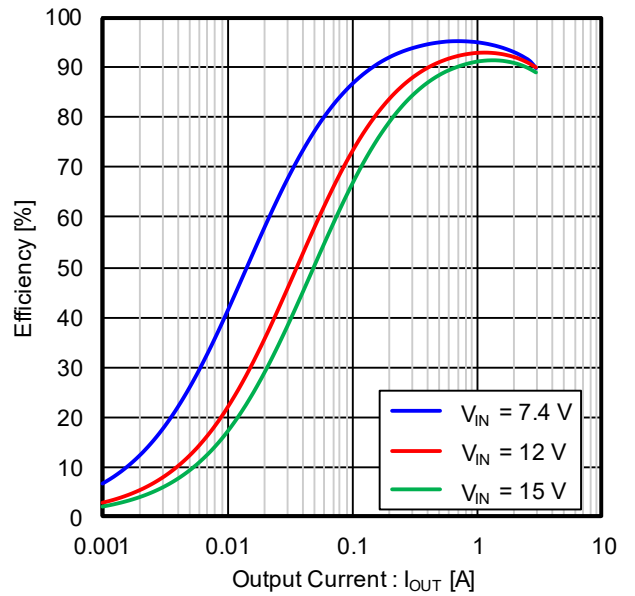

Figure 4. Efficiency vs Output Current (V_{OUT} = 5 V, L = 2.2 µH, MODE = High)

Typical Performance Curves – continued

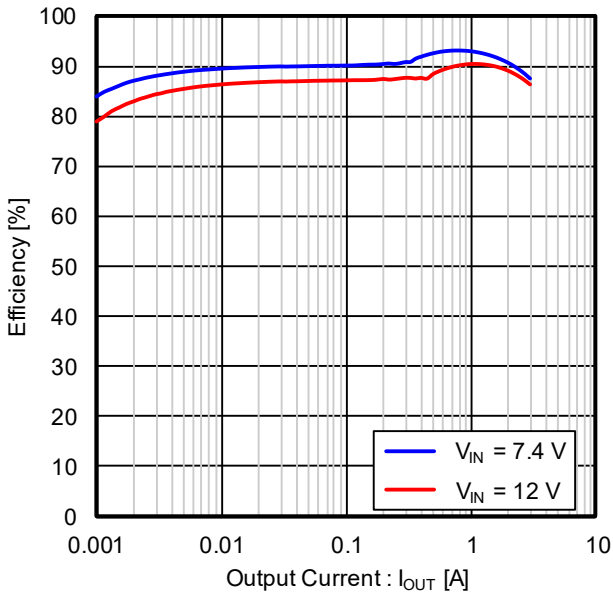

Figure 5. Efficiency vs Output Current (V_{OUT} = 3.3 V, L = 2.2 μH, MODE = Low)

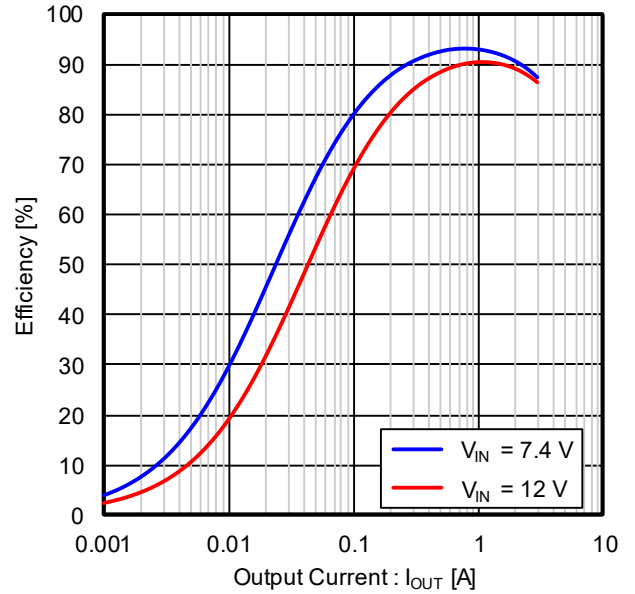

Figure 6. Efficiency vs Output Current (V_{OUT} = 3.3 V, L = 2.2 μH, MODE = High)

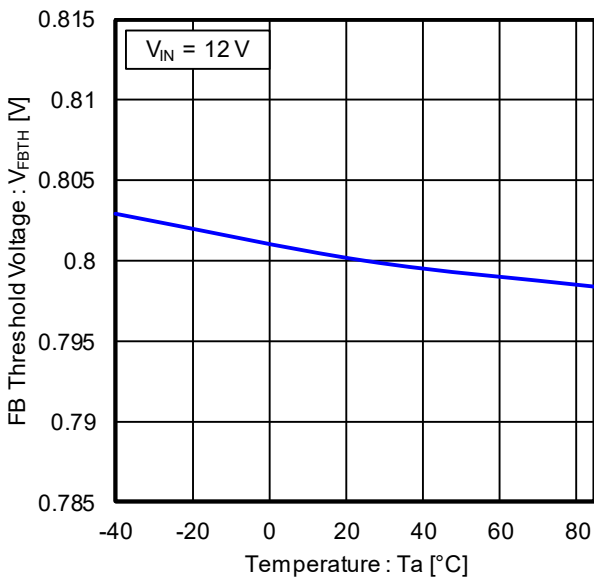

Figure 7. FB Threshold Voltage vs Temperature

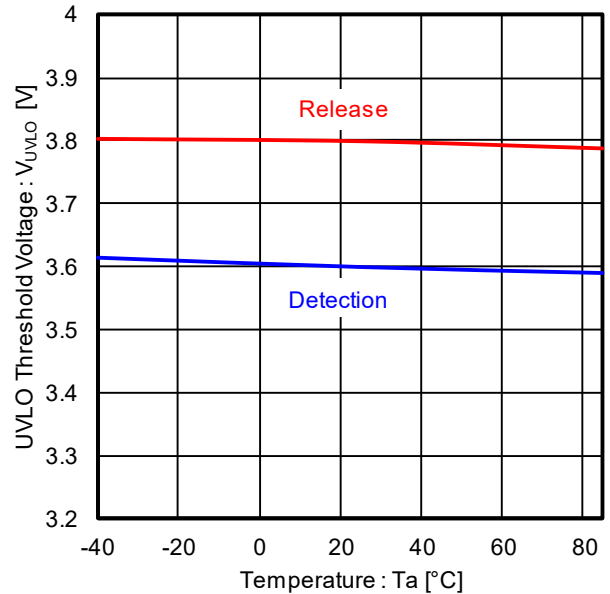

Figure 8. UVLO Threshold Voltage vs Temperature

Typical Performance Curves – continued

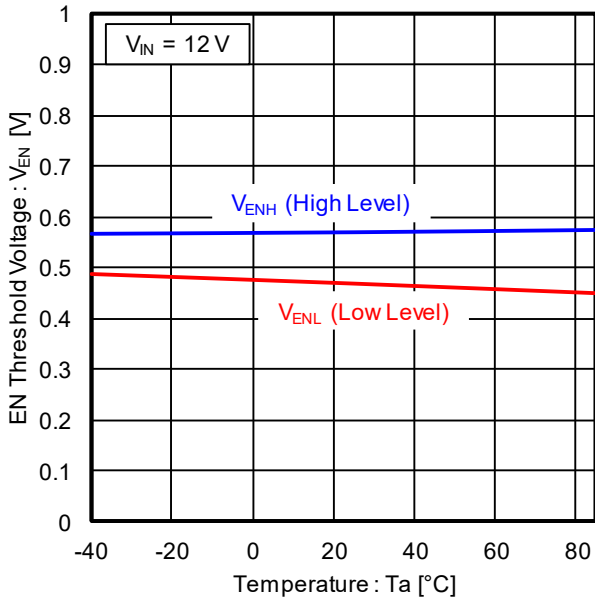

Figure 9. EN Threshold Voltage vs Temperature

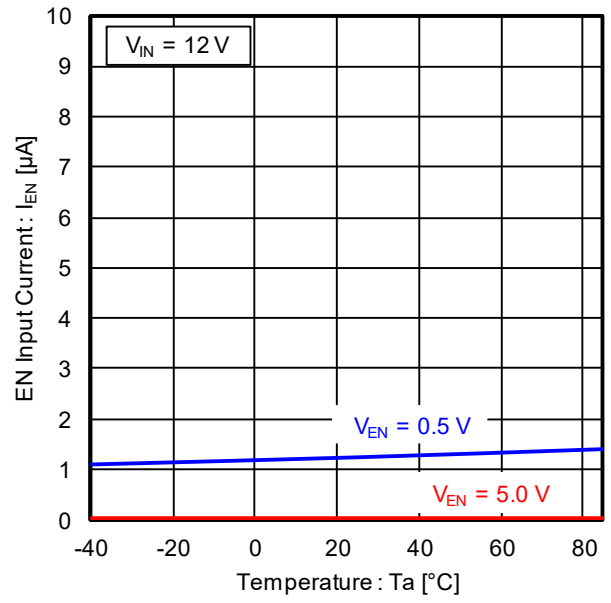

Figure 10. EN Input Current vs Temperature

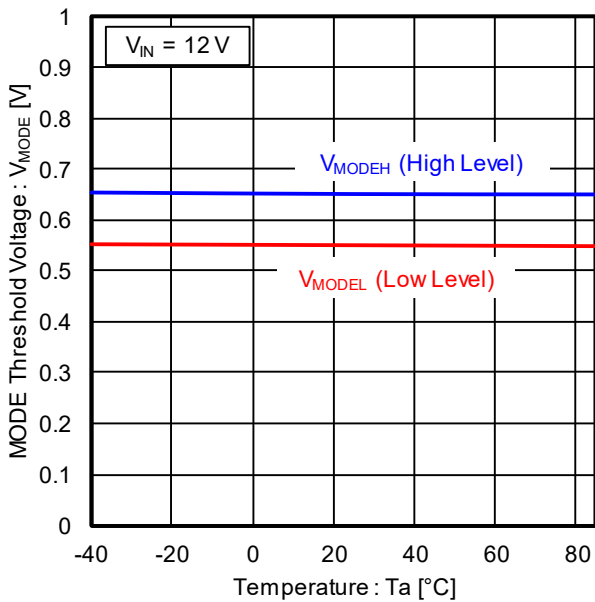

Figure 11. MODE Threshold Voltage vs Temperature

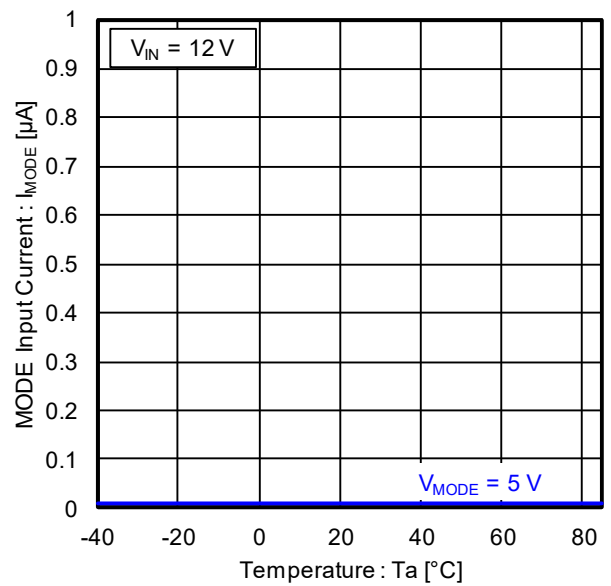

Figure 12. MODE Input Current vs Temperature

Typical Performance Curves – continued

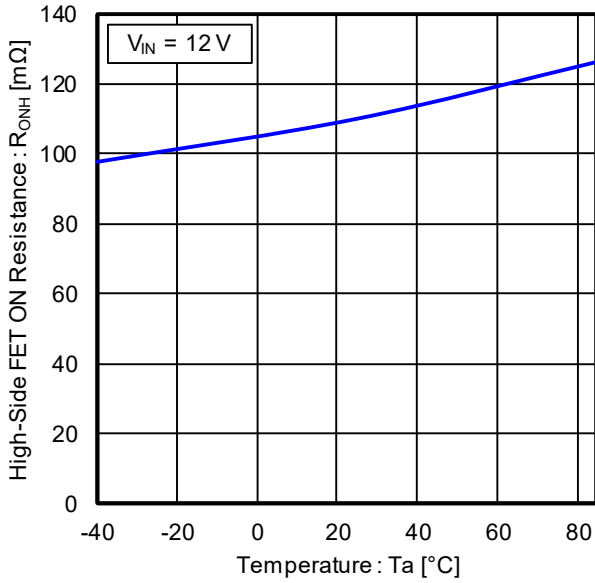

Figure 13. High-Side FET ON Resistance vs Temperature

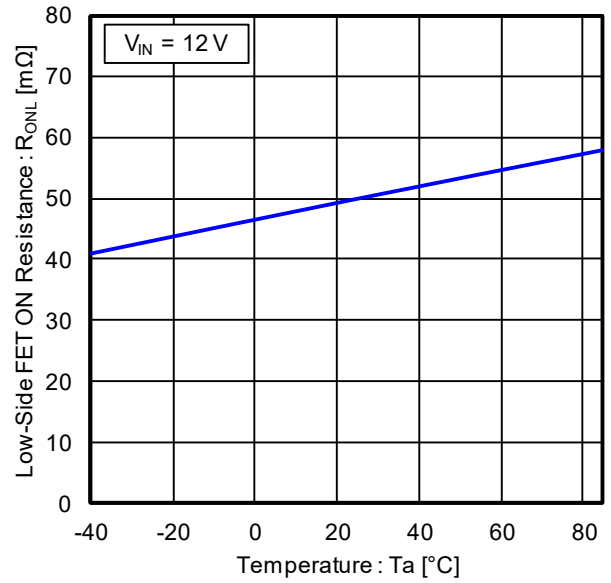

Figure 14. Low-Side FET ON Resistance vs Temperature

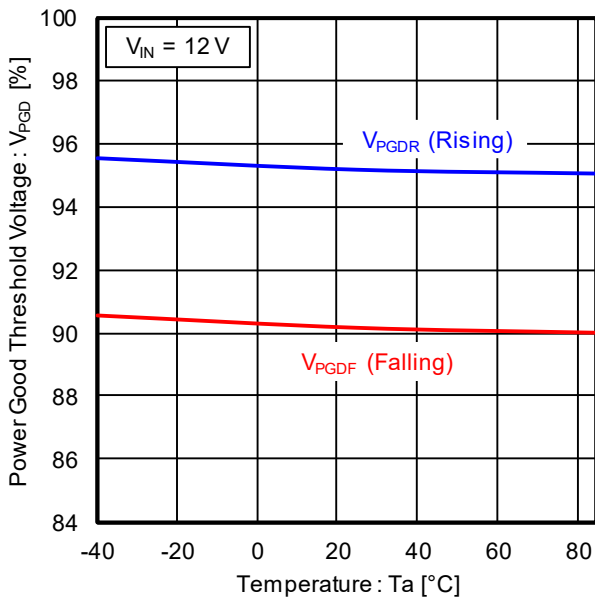

Figure 15. Power Good Threshold Voltage vs Temperature

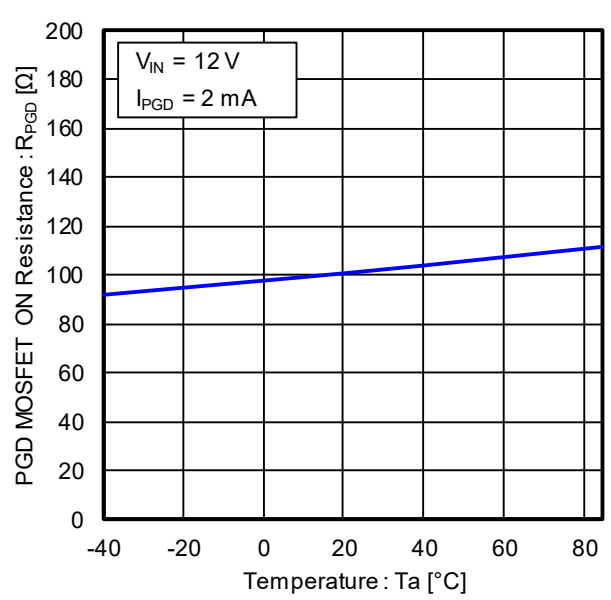

Figure 16. PGD MOSFET ON Resistance vs Temperature

Typical Performance Curves – continued

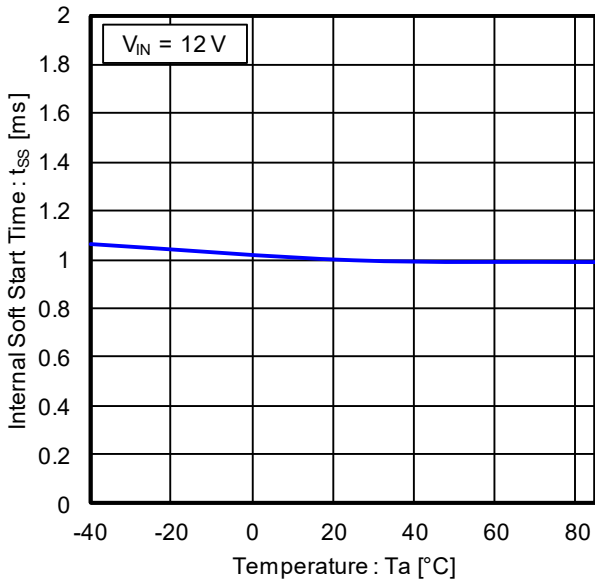

Figure 17. Internal Soft Start Time vs Temperature

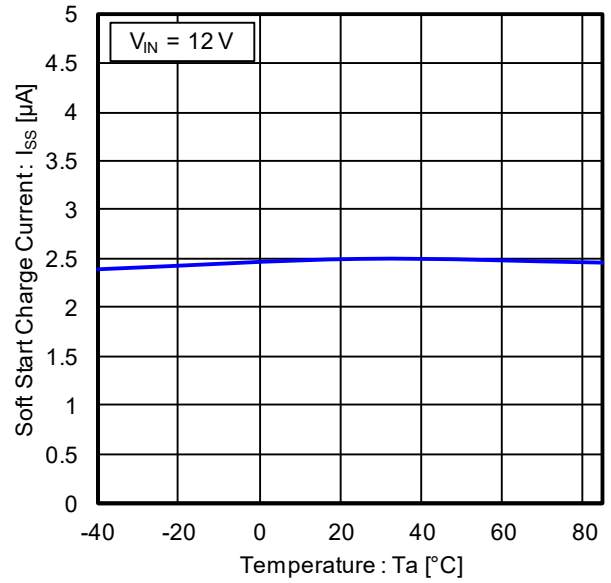

Figure 18. Soft Start Charge Current vs Temperature

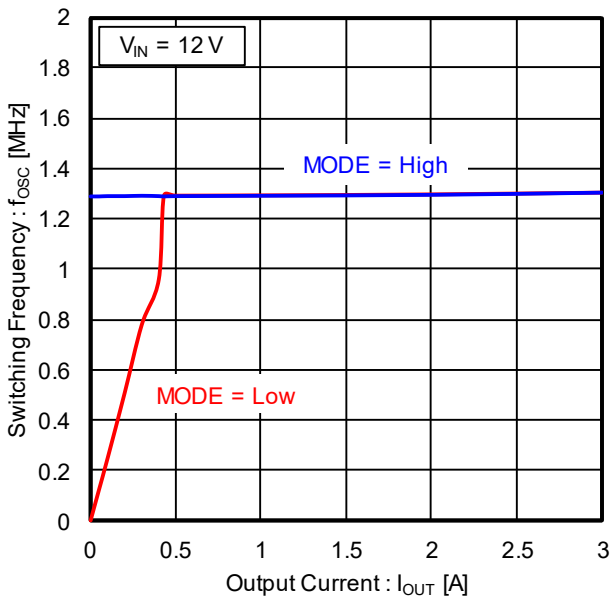

Figure 19. Switching Frequency vs Output Current
(VIN = 12 V, VOUT = 5 V)

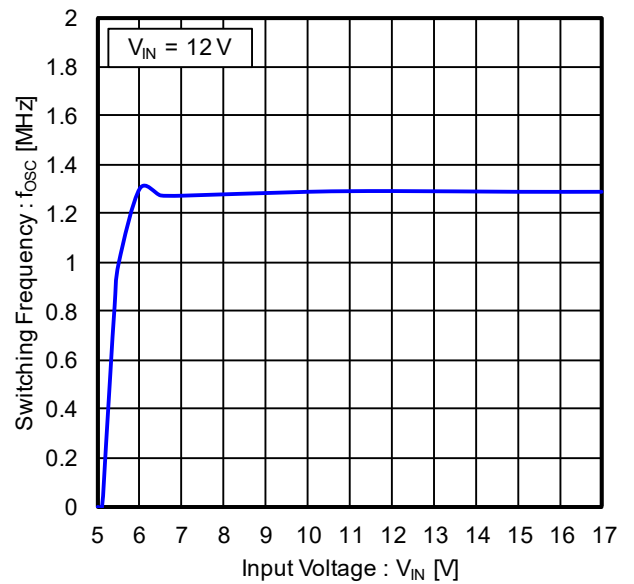

Figure 20. Switching Frequency vs Input Voltage
(VOUT = 5.0 V, Iout = 1 A, MODE = High)

Typical Performance Curves – continued

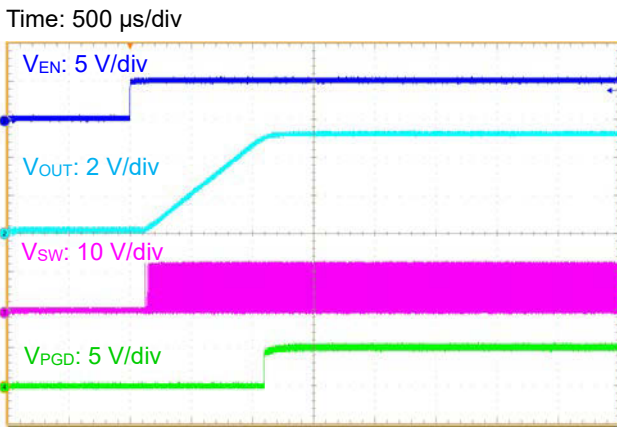

Figure 21. EN Start-up Waveform
($V_{IN} = 12\text{ V}$, $V_{OUT} = 5\text{ V}$, $R_{LOAD} = 5\ \Omega$, $MODE = Low$)

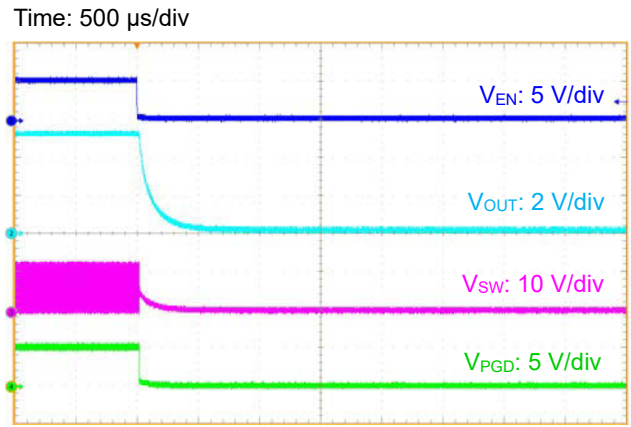

Figure 22. EN Shutdown Waveform
($V_{IN} = 12\text{ V}$, $V_{OUT} = 5\text{ V}$, $R_{LOAD} = 5\ \Omega$, $MODE = Low$)

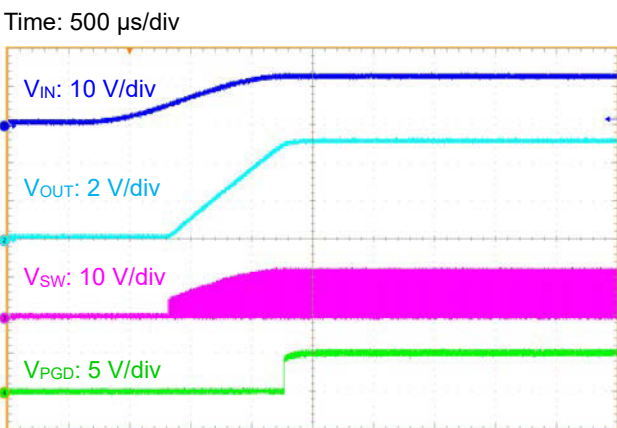

Figure 23. VIN Start-up Waveform
($V_{OUT} = 5\text{ V}$, $R_{LOAD} = 5\ \Omega$, $MODE = Low$, $V_{PVIN} = V_{AVIN} = V_{EN}$)

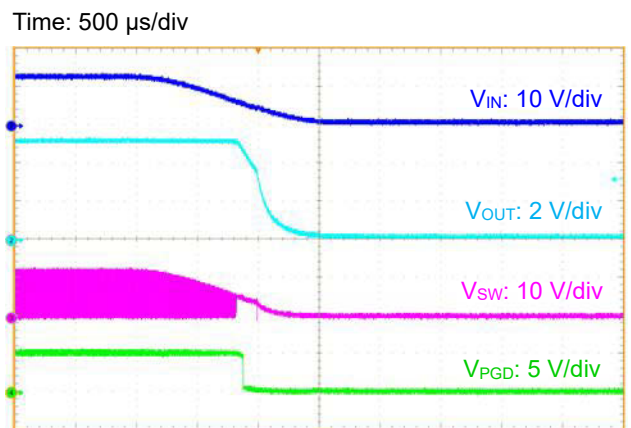

Figure 24. VIN Shutdown Waveform
($V_{OUT} = 5\text{ V}$, $R_{LOAD} = 5\ \Omega$, $MODE = Low$, $V_{PVIN} = V_{AVIN} = V_{EN}$)

Typical Performance Curves – continued

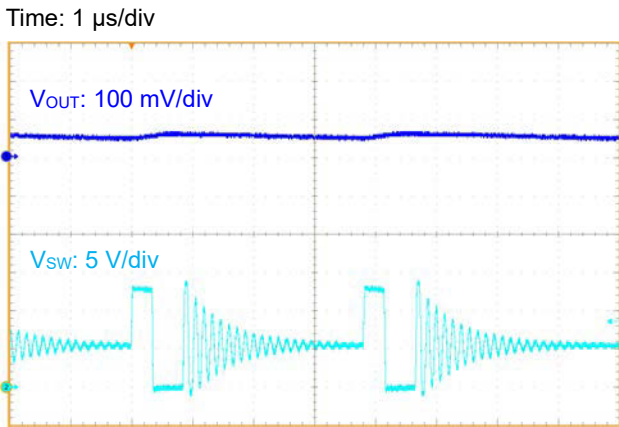

Figure 25. Switching Waveform
 ($V_{IN} = 12\text{ V}$, $V_{OUT} = 5\text{ V}$, $I_{OUT} = 0.1\text{ A}$, $L = 2.2\text{ }\mu\text{H}$, $C_{OUT} = 47\text{ }\mu\text{F}$,
 MODE = Low)

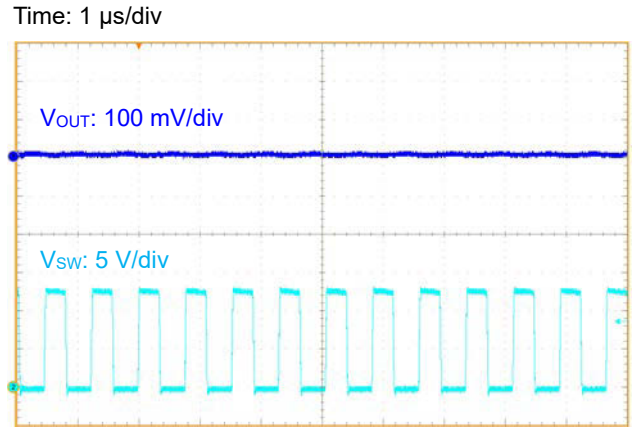

Figure 26. Switching Waveform
 ($V_{IN} = 12\text{ V}$, $V_{OUT} = 5\text{ V}$, $I_{OUT} = 3.0\text{ A}$, $L = 2.2\text{ }\mu\text{H}$, $C_{OUT} = 47\text{ }\mu\text{F}$,
 MODE = Low)

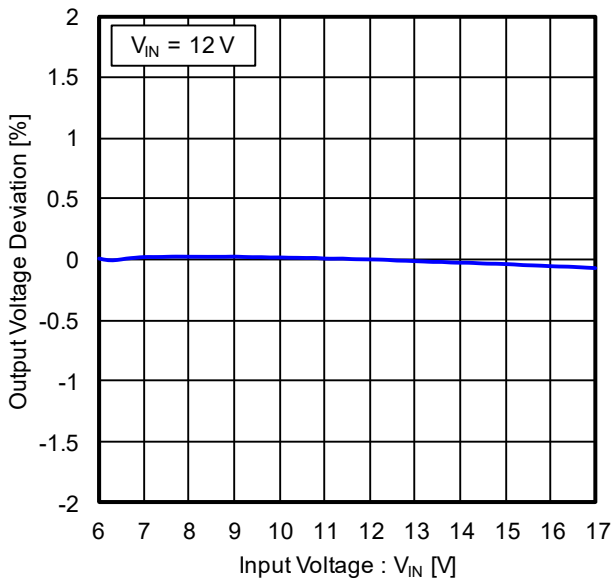

Figure 27. Line Regulation
 ($V_{OUT} = 5\text{ V}$, $L = 2.2\text{ }\mu\text{H}$, $I_{OUT} = 3.0\text{ A}$)

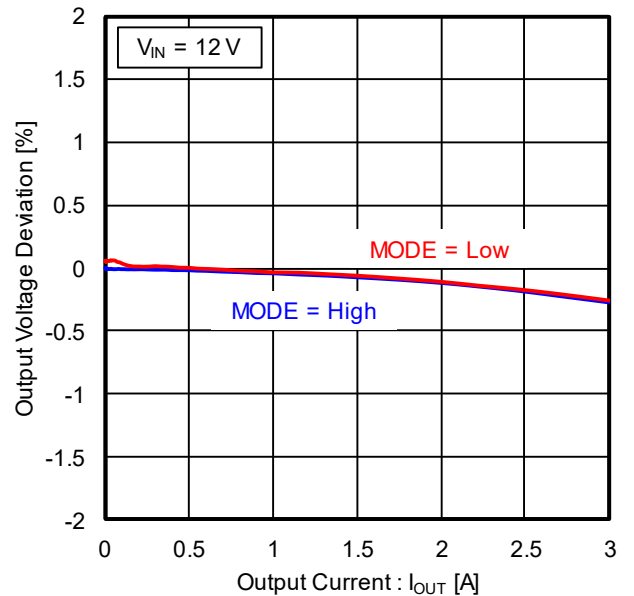

Figure 28. Load Regulation
 ($V_{IN} = 12\text{ V}$, $V_{OUT} = 5\text{ V}$, $L = 2.2\text{ }\mu\text{H}$)

Function Explanations

1. Basic Operation

(1) DC/DC Converter Operation

BD9D300MUV is a synchronous rectifying step-down switching regulator that has original on-time control method. When the MODE pin is connected to Ground, it utilizes switching operation in Pulse Width Modulation (PWM) mode control for heavier load, and it operates in Light Load mode control at lighter load to improve efficiency. When the MODE pin is connected to the VOUTS pin, the device operates in PWM mode control regardless of the load.

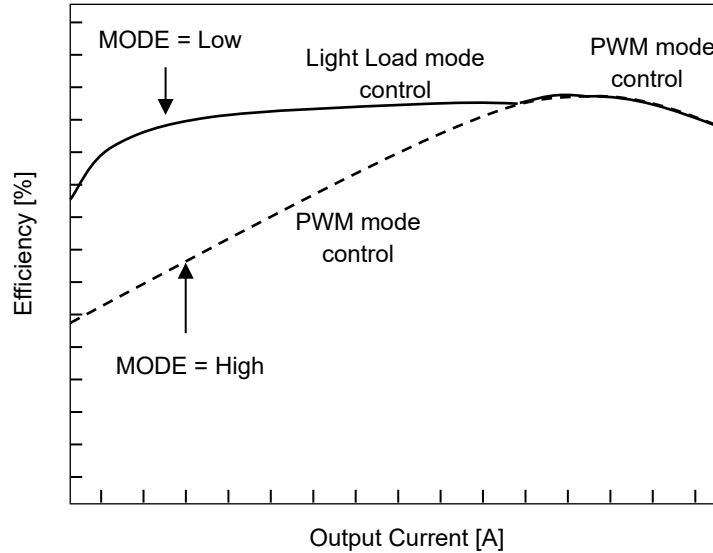

Figure 29. Efficiency Image between Light Load Mode Control and PWM Mode Control

(2) Enable Control

The start-up and shutdown can be controlled by the EN voltage (V_{EN}). When V_{EN} becomes 0.9 V (Min) or more, the internal circuit is activated and the device starts up. When V_{EN} becomes 0.3 V (Max) or less, the device is shut down. The start-up with V_{EN} must be at the same time of the input voltage ($V_{IN}=V_{EN}$) or after supplying V_{IN} .

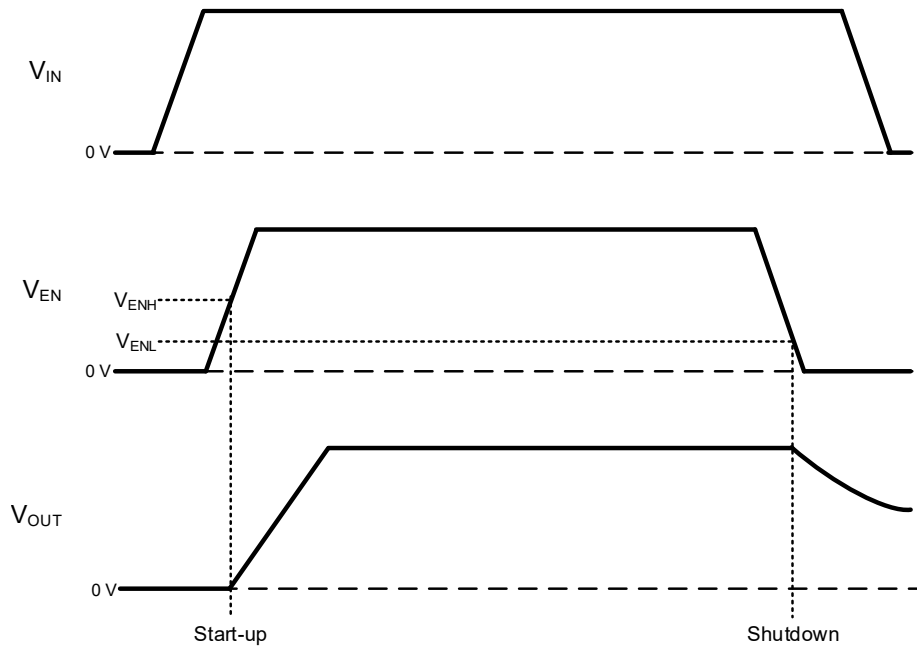

Figure 30. Start-up and Shutdown with Enable Control Timing Chart

1. Basic Operation – continued

(3) Soft Start

When V_{EN} goes high, soft start function operates and output voltage gradually rises. This soft start function can prevent overshoot of the output voltage and excessive inrush current. The soft start time (t_{ss}) is 1 ms (Typ) when the SS pin is left floating. A capacitor connected to the SS pin makes t_{ss} more than 1 ms. See [page 32](#) for how to set the soft start time. When Short Circuit Protection (SCP) is released, t_{ss} is 1 ms (Typ) regardless of a capacitor connected to the SS pin.

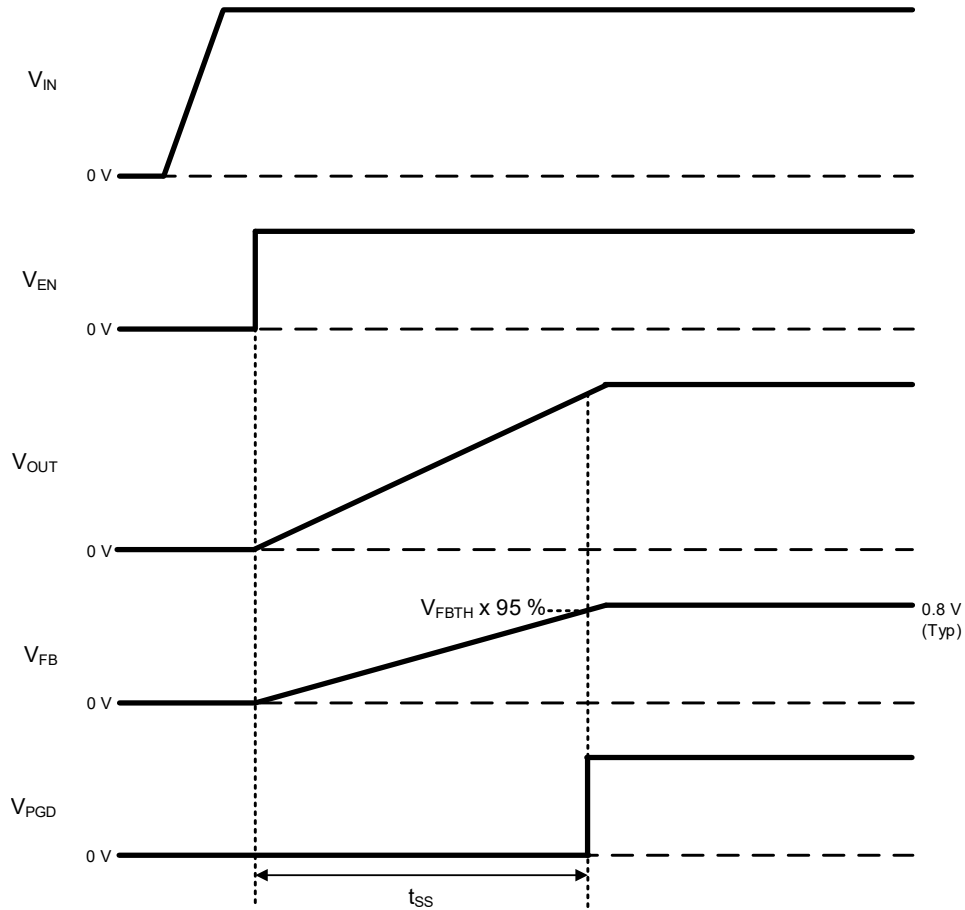

Figure 31. Soft Start Timing Chart

(4) Power Good

When the FB voltage (V_{FB}) is more than or equal to 95 % (Typ) of 0.8 V, the built-in open drain Nch MOSFET connected to the PGD pin is off, and the PGD pin becomes Hi-Z (High impedance). When V_{FB} is less than or equal to 90 % (Typ) of 0.8V, it turns on the built-in open drain Nch MOSFET turns on and the PGD pin is pulled down with 100 Ω (Typ). It is recommended to connect a pull-up resistor of 10 k Ω to 100 k Ω to the VOUTS pin.

Table 1. PGD Output

State	Condition	PGD Output
Before Supply Input Voltage	$V_{IN} < 1.6 \text{ V (Typ)}$	Hi-Z
Shutdown	$V_{EN} \leq 0.3 \text{ V (Max)}$	Low (Pull-down)
Enable $V_{EN} \geq 0.9 \text{ V (Min)}$	$95 \% \text{ (Typ)} \leq V_{FB} / V_{FBTH}$	Hi-Z
	$V_{FB} / V_{FBTH} \leq 90 \% \text{ (Typ)}$	Low (Pull-down)
UVLO	$1.6 \text{ V (Typ)} < V_{IN} \leq 3.6 \text{ V (Typ)}$	Low (Pull-down)
TSD	$T_j \geq 175 \text{ }^\circ\text{C (Typ)}$	Low (Pull-down)
OVP	$120 \% \text{ (Typ)} \leq V_{FB} / V_{FBTH}, 5.95 \text{ V (Typ)} \leq V_{VOUTS}$	Low (Pull-down)
SCP	Complete Soft Start $V_{FB} / V_{FBTH} \leq 90 \% \text{ (Typ)}$ OCP 256 counts	Low (Pull-down)

(4) Power Good – continued

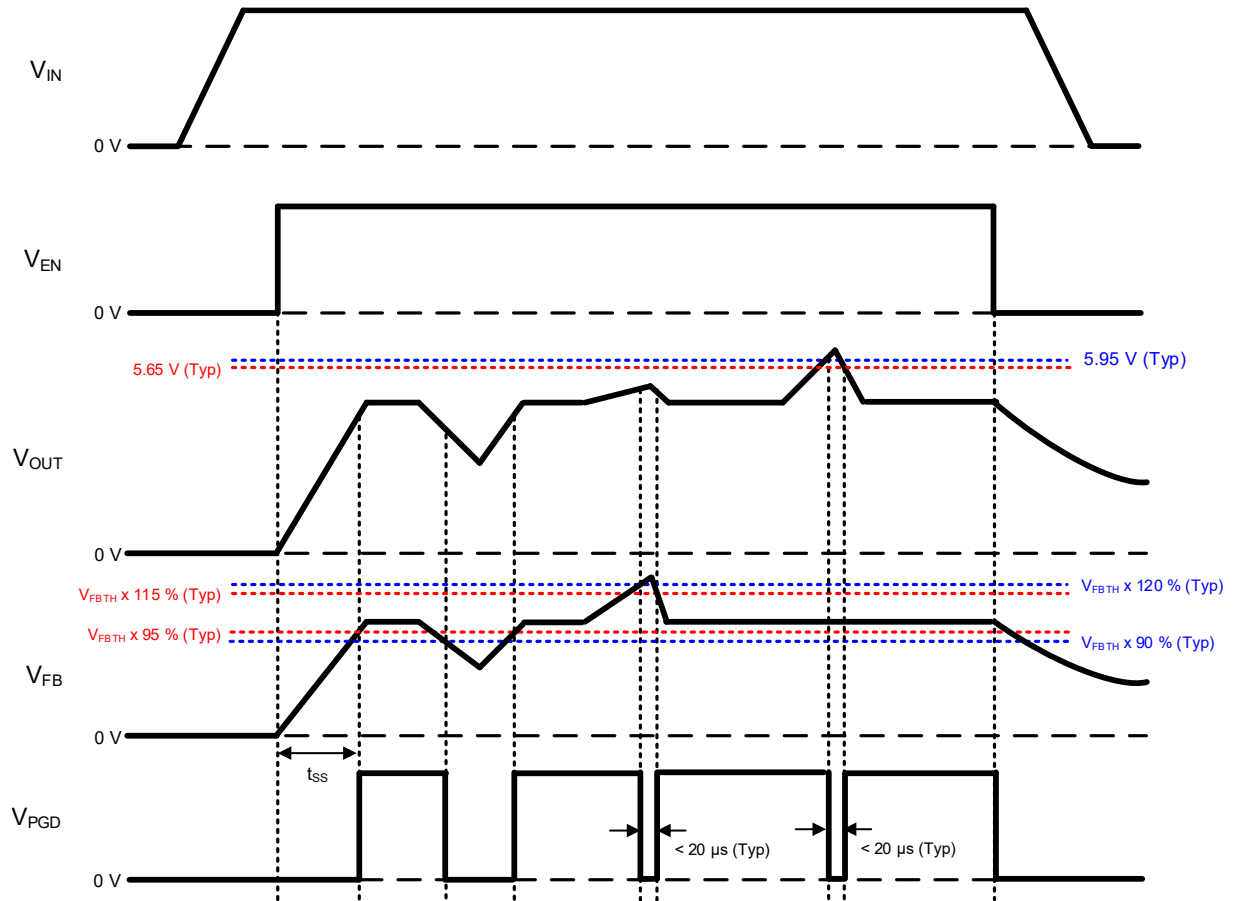

Figure 32. Power Good Timing Chart
(Connecting a pull-up resistor to the PGD pin)

Function Explanations – continued

2. Protection

The protection circuits are intended for prevention of damage caused by unexpected accidents. Do not use the continuous protection.

(1) Over Current Protection (OCP) / Short Circuit Protection (SCP)

Over Current Protection (OCP) restricts the flowing current through the Low-Side FET or High-Side FET for every switching period. If the inductor current exceeds the Low-Side OCP $I_{LOCP} = 3.8 \text{ A}$ (Typ) while the Low-Side FET is on, the Low-Side FET remains on even with FB voltage (V_{FB}) falls to $V_{FBTH} = 0.8 \text{ V}$ (Typ) or less. If the inductor current becomes lower than I_{LOCP} , the High-Side FET is able to be turned on. When the inductor current is the High-Side OCP $I_{HOCP} = 4.8 \text{ A}$ (Typ) or more while the High-Side FET is on, it is turned off. Output voltage may decrease by changing frequency and duty due to OCP operation.

Short Circuit Protection (SCP) function is a Hiccup mode. When OCP operates 256 cycles while V_{FB} is less than or equal to 90 % (Typ) of 0.8V ($V_{PGD} = \text{Low}$), the device stops the switching operation for 15 ms (Typ). After 15 ms (Typ), the device restarts. SCP does not operate during the soft start even if the device is in the SCP condition. Do not exceed the maximum junction temperature ($T_{jmax} = 150 \text{ }^\circ\text{C}$) during OCP and SCP operation.

Table 2. The Operating Condition of OCP and SCP

V_{EN}	V_{FB}	Start-up	OCP	SCP
$\geq 0.9 \text{ V (Typ)}$	$\leq V_{FBTH} \times 90 \% \text{ (Typ)}$	During Soft Start	Enable	Disable
	$> V_{FBTH} \times 95 \% \text{ (Typ)}$	Complete Soft Start	Enable	Disable
	$\leq V_{FBTH} \times 90 \% \text{ (Typ)}$		Enable	Enable
$\leq 0.3 \text{ V (Typ)}$	-	Shutdown	Disable	Disable

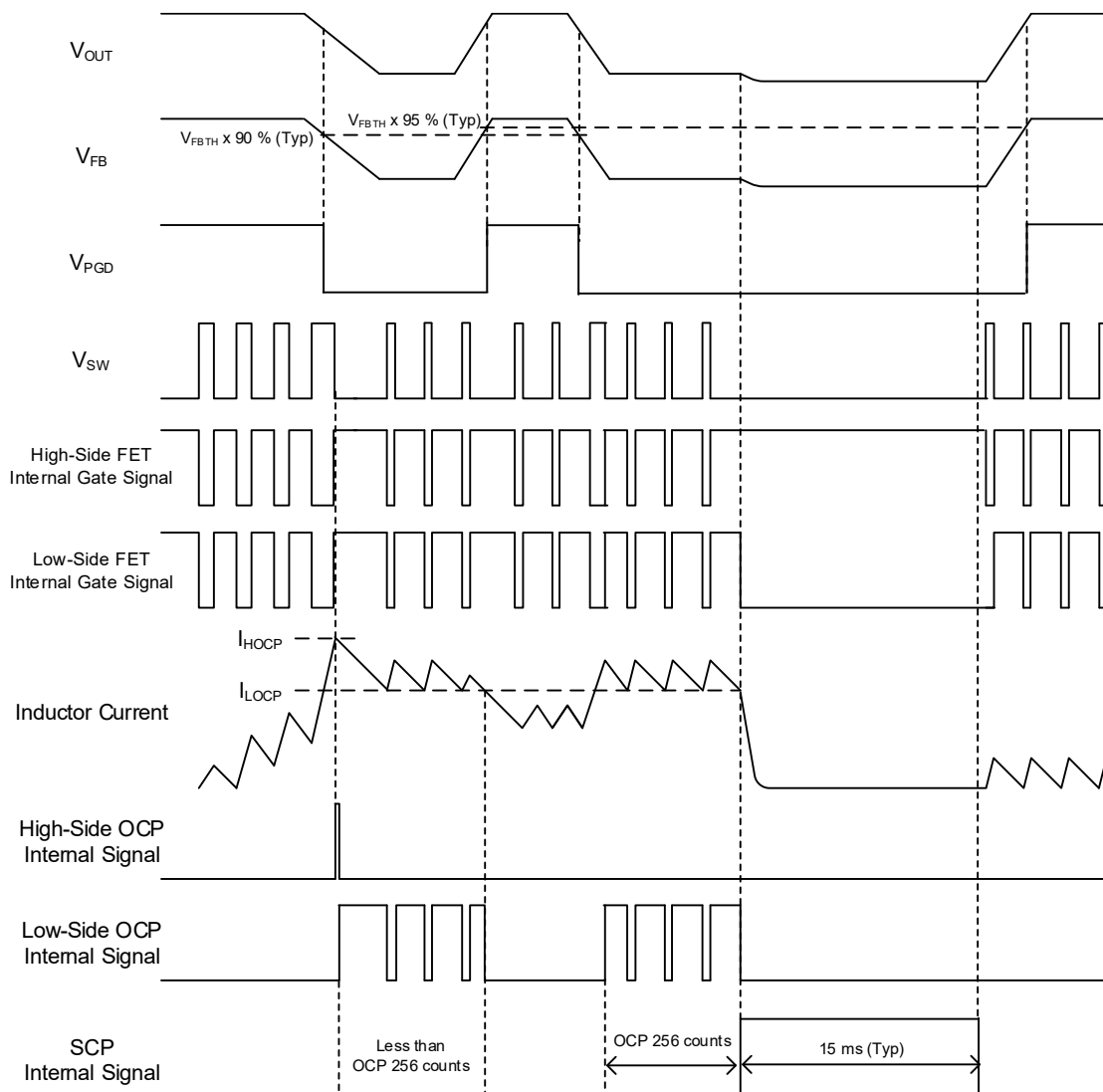

Figure 33. OCP and SCP Timing Chart

2. Protection – continued

(2) Under Voltage Lockout Protection (UVLO)

When input voltage (V_{IN}) falls to 3.6 V (Typ) or less, the device is shut down. When V_{IN} becomes 3.8 V (Typ) or more, the device starts up. The hysteresis is 200 mV (Typ).

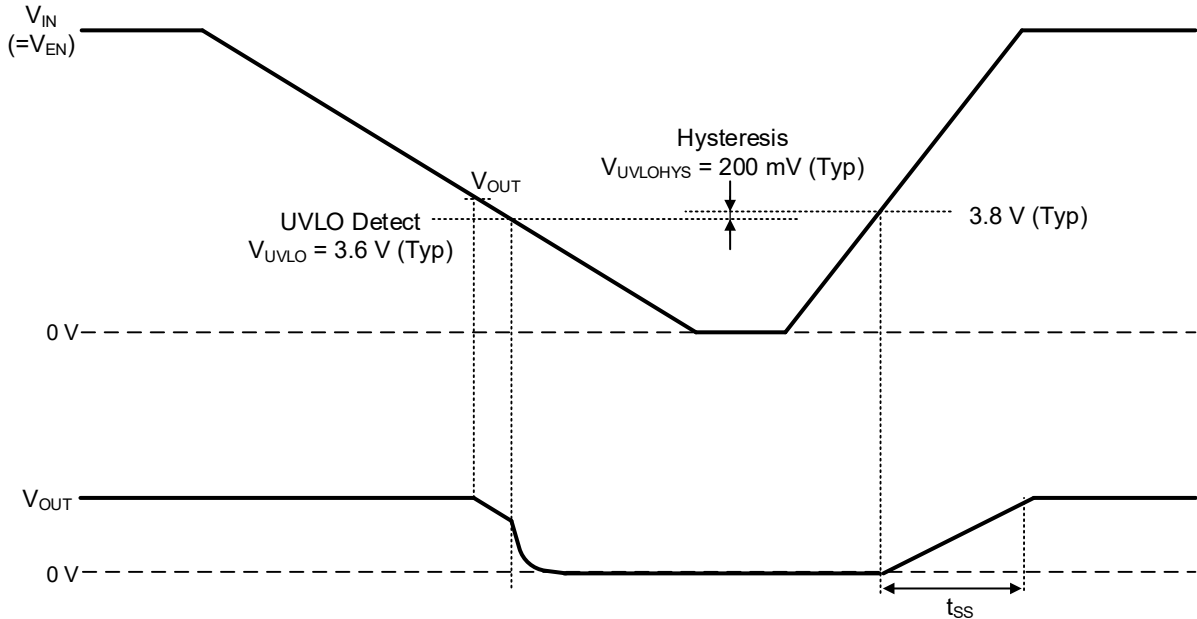

Figure 34. UVLO Timing Chart

(3) Thermal Shutdown Protection (TSD)

Thermal shutdown circuit prevents heat damage to the IC. Normal operation should always be within the IC's maximum junction temperature rating ($T_{jmax} = 150 \text{ }^\circ\text{C}$). However, if it continues exceeding the rating and the junction temperature T_j rises to $175 \text{ }^\circ\text{C}$ (Typ), the TSD circuit is activated and it turns the output MOSFETs off. When the T_j falls below the TSD threshold, the circuits are automatically restored to normal operation. The TSD threshold has a hysteresis of $25 \text{ }^\circ\text{C}$ (Typ). Note that the TSD circuit operates in a situation that exceeds the absolute maximum ratings. Therefore, under no circumstances, should the TSD circuit be used in a set design or for any purpose other than protecting the IC from heat damage.

(4) Over Voltage Protection (OVP)

When V_{FB} is more than or equal to 120 % (Typ) of 0.8 V, the output MOSFETs are off. After V_{FB} is less than or equal to 115 % (Typ) of 0.8 V, the output MOSFETs are returned to normal operation condition. In addition, when V_{OVS} voltage (V_{OVS}) reaches 5.95 V (Typ) or more, the output MOSFETs are off. After V_{OVS} falls 5.65 V (Typ) or less, the output MOSFETs are returned to normal operation condition. If the condition of the over voltage protection is continued for 20 μs (Typ), the output MOSFETs are latched to off, and it re-operates by Enable control or UVLO function.

Application Examples

1. $V_{IN} = 12\text{ V} / V_{OUT} = 5.0\text{ V}$

Table 3. Specification of Application ($V_{IN} = 12\text{ V} / V_{OUT} = 5.0\text{ V}$)

Parameter	Symbol	Specification Value
Input Voltage	V_{IN}	12 V
Output Voltage	V_{OUT}	5.0 V
Switching Frequency	f_{osc}	1.25 MHz (Typ)
Maximum Output Current	I_{OUTMAX}	3 A
Operating Temperature	T_a	25 °C

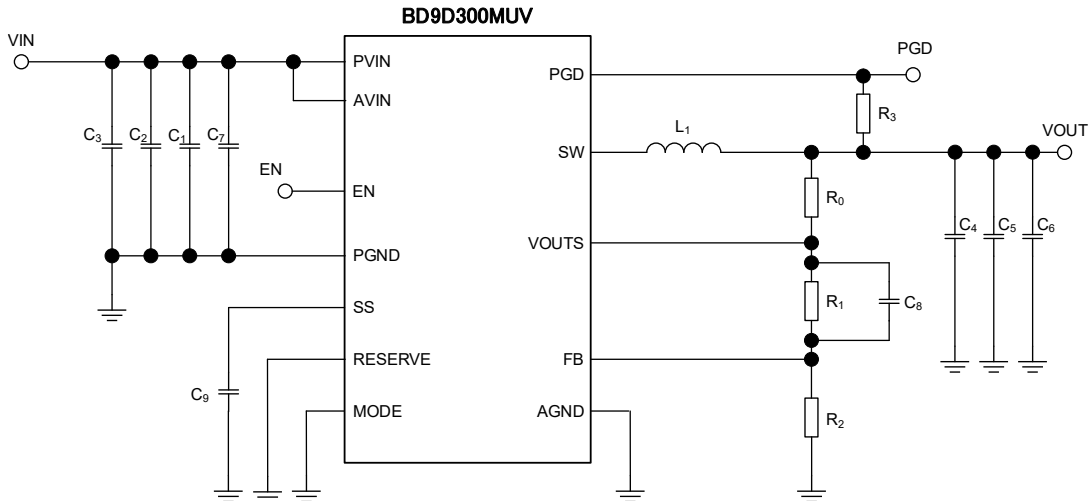

Figure 35. Application Circuit

Table 4. Recommended Component Values (Note 1) ($V_{IN} = 12\text{ V} / V_{OUT} = 5.0\text{ V}$)

Part No.	Value	Part Name	Size (mm)	Manufacturer
L ₁	2.2 μH	FDS0518-H-2R2M	5249	Murata
C ₁ (Note 2)	10 μF (35 V / X5R)	GRM21BR6YA106ME43	2012	Murata
C ₂	-	-	-	-
C ₃	-	-	-	-
C ₄ (Note 3)	47 μF (16 V / X5R)	GRM31CR61C476ME44	3216	Murata
C ₅	-	-	-	-
C ₆	-	-	-	-
C ₇ (Note 4)	0.1 μF (35 V / X5R)	GRM033R6YA104ME14	0603	Murata
C ₈	-	-	-	-
C ₉	-	-	-	-
R ₁	270 kΩ (1 %, 1/16 W)	MCR01MZPF2703	1005	ROHM
R ₂	51 kΩ (1 %, 1/16 W)	MCR01MZPF5102	1005	ROHM
R ₃	100 kΩ (1 %, 1/16 W)	MCR01MZPF1003	1005	ROHM
R ₀ (Note 5)	Short	-	-	-

(Note 1) You agree that this is presented only as guidance for products use. Confirm on the actual equipment considering variations of the characteristics of the product and external components.

(Note 2) For the capacitance of input capacitor, take temperature characteristics, DC bias characteristics, etc. into consideration to set to a minimum value of no less than 2 μF.

(Note 3) In case capacitance value fluctuates due to temperature characteristics, DC bias characteristics, etc. of the output capacitor, loop response characteristics may change. Confirm on the actual equipment. When selecting a capacitor, confirm the characteristics of the capacitor in its datasheet.

(Note 4) In order to reduce the influence of high frequency noise, connect a 0.1 μF ceramic capacitor as close as possible to the PVIN pin and the PGND pin if needed.

(Note 5) R₀ is an option used for feedback's frequency response measurement. By inserting a resistor at R₀, it is possible to measure the frequency response (phase margin) using a FRA. However, the resistor will not be used in actual application, use this resistor pattern in short-circuit mode.

1. $V_{IN} = 12\text{ V} / V_{OUT} = 5.0\text{ V}$ – continued

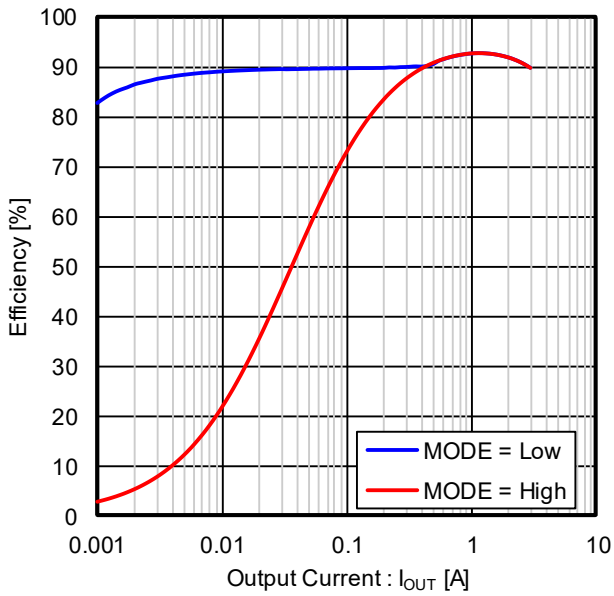

Figure 36. Efficiency vs Output Current

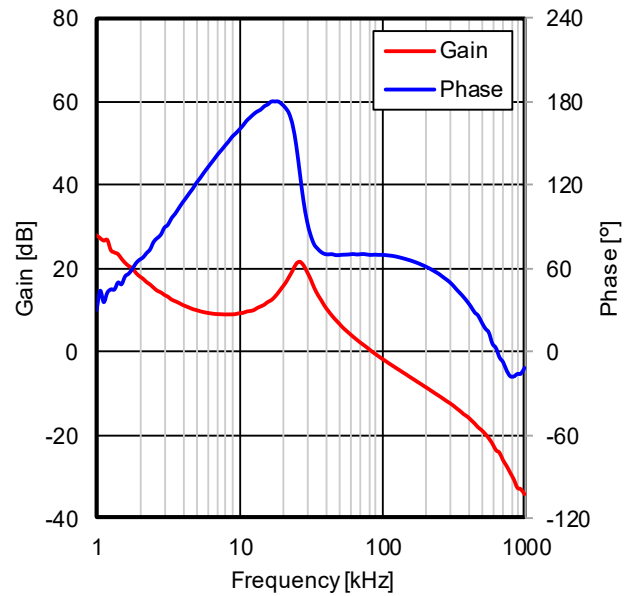

Figure 37. Frequency Characteristics $I_{OUT} = 2.0\text{ A}$

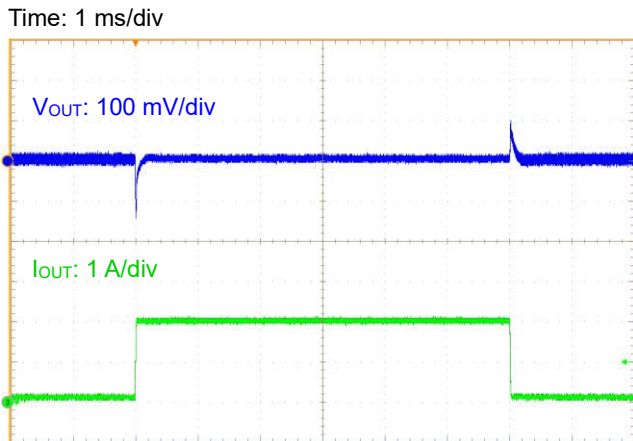

Figure 38. Load Transient Response $I_{OUT} = 0.1\text{ A} - 2.0\text{ A}$ (MODE = Low)

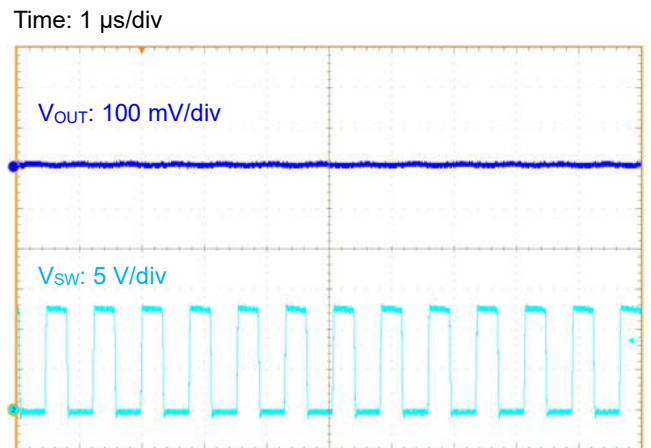

Figure 39. V_{OUT} Ripple $I_{OUT} = 3.0\text{ A}$ (MODE = High)

Application Examples – continued

2. $V_{IN} = 7.4 \text{ V} / V_{OUT} = 5.0 \text{ V}$

Table 5. Specification of Application ($V_{IN} = 7.4 \text{ V} / V_{OUT} = 5.0 \text{ V}$)

Parameter	Symbol	Specification Value
Input Voltage	V_{IN}	7.4 V
Output Voltage	V_{OUT}	5.0 V
Switching Frequency	f_{osc}	1.25 MHz (Typ)
Maximum Output Current	I_{OUTMAX}	3 A
Operating Temperature	T_a	25 °C

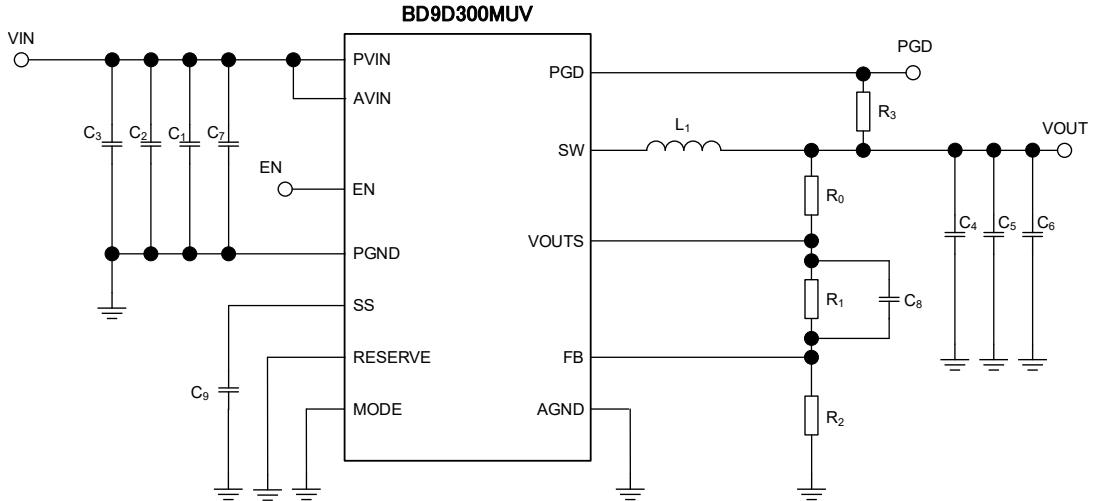

Figure 40. Application Circuit

Table 6. Recommended Component Values ^(Note 1) ($V_{IN} = 7.4 \text{ V} / V_{OUT} = 5.0 \text{ V}$)

Part No.	Value	Part Name	Size (mm)	Manufacturer
L ₁	2.2 μH	FDS0518-H-2R2M	5249	Murata
C ₁ ^(Note 2)	10 μF (35 V / X5R)	GRM21BR6YA106ME43	2012	Murata
C ₂	-	-	-	-
C ₃	-	-	-	-
C ₄ ^(Note 3)	47 μF (16 V / X5R)	GRM31CR61C476ME44	3216	Murata
C ₅	-	-	-	-
C ₆	-	-	-	-
C ₇ ^(Note 4)	0.1 μF (35 V / X5R)	GRM033R6YA104ME14	0603	Murata
C ₈	-	-	-	-
C ₉	-	-	-	-
R ₁	270 k Ω (1 %, 1/16 W)	MCR01MZPF2703	1005	ROHM
R ₂	51 k Ω (1 %, 1/16 W)	MCR01MZPF5102	1005	ROHM
R ₃	100 k Ω (1 %, 1/16 W)	MCR01MZPF1003	1005	ROHM
R ₀ ^(Note 5)	Short	-	-	-

(Note 1) You agree that this is presented only as guidance for products use. Confirm on the actual equipment considering variations of the characteristics of the product and external components.

(Note 2) For the capacitance of input capacitor, take temperature characteristics, DC bias characteristics, etc. into consideration to set to a minimum value of no less than 2 μF .

(Note 3) In case capacitance value fluctuates due to temperature characteristics, DC bias characteristics, etc. of the output capacitor, loop response characteristics may change. Confirm on the actual equipment. When selecting a capacitor, confirm the characteristics of the capacitor in its datasheet.

(Note 4) In order to reduce the influence of high frequency noise, connect a 0.1 μF ceramic capacitor as close as possible to the PVIN pin and the PGND pin if needed.

(Note 5) R₀ is an option used for feedback's frequency response measurement. By inserting a resistor at R₀, it is possible to measure the frequency response (phase margin) using a FRA. However, the resistor will not be used in actual application, use this resistor pattern in short-circuit mode.

2. $V_{IN} = 7.4\text{ V} / V_{OUT} = 5.0\text{ V}$ – continued

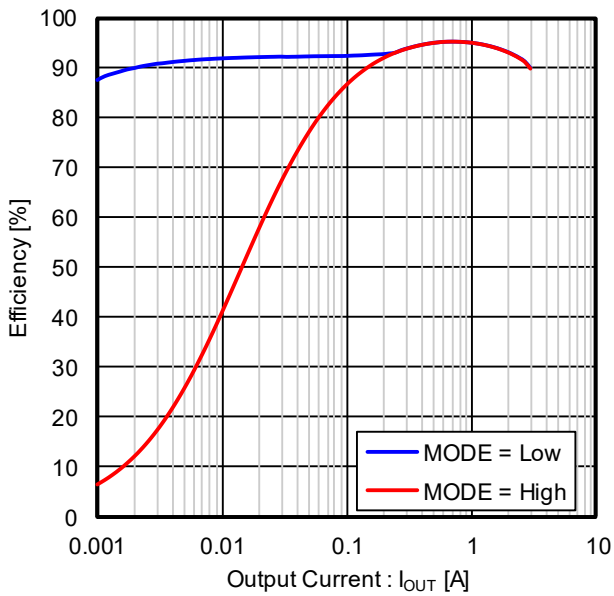

Figure 41. Efficiency vs Output Current

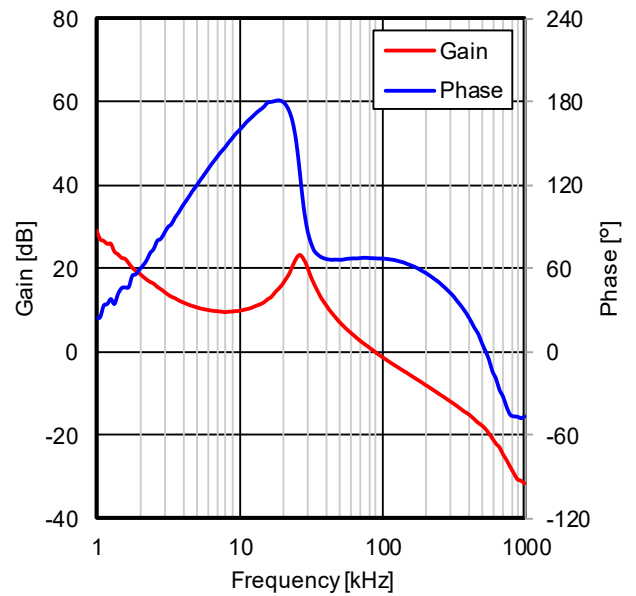

Figure 42. Frequency Characteristics $I_{OUT} = 2.0\text{ A}$

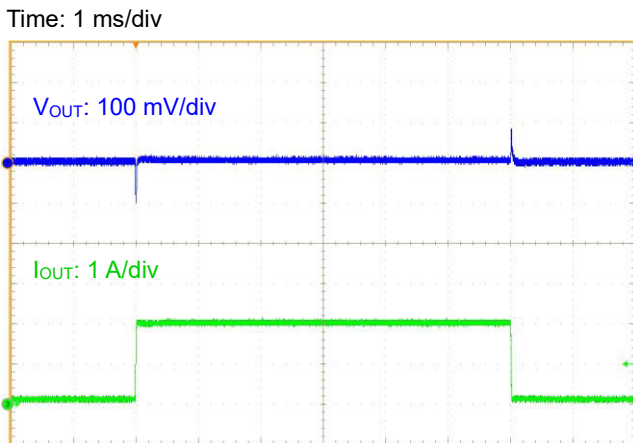

Figure 43. Load Transient Response $I_{OUT} = 0.1\text{ A} - 2.0\text{ A}$ (MODE = Low)

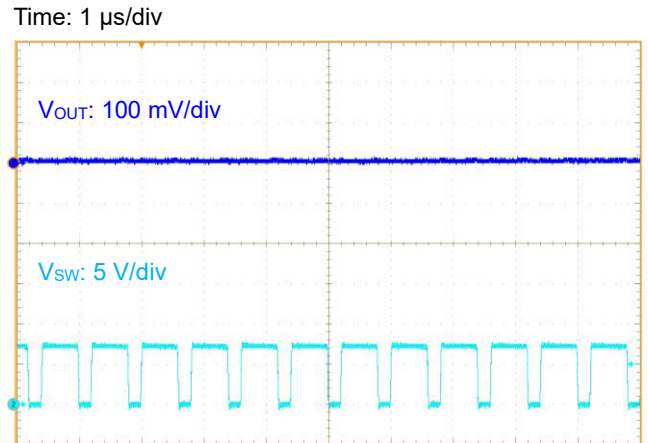

Figure 44. V_{OUT} Ripple $I_{OUT} = 3.0\text{ A}$ (MODE = High)

Application Examples – continued

3. $V_{IN} = 12\text{ V} / V_{OUT} = 3.3\text{ V}$

Table 7. Specification of Application ($V_{IN} = 12\text{ V} / V_{OUT} = 3.3\text{ V}$)

Parameter	Symbol	Specification Value
Input Voltage	V_{IN}	12 V
Output Voltage	V_{OUT}	3.3 V
Switching Frequency	f_{osc}	1.25 MHz (Typ)
Maximum Output Current	I_{OUTMAX}	3 A
Operating Temperature	T_a	25 °C

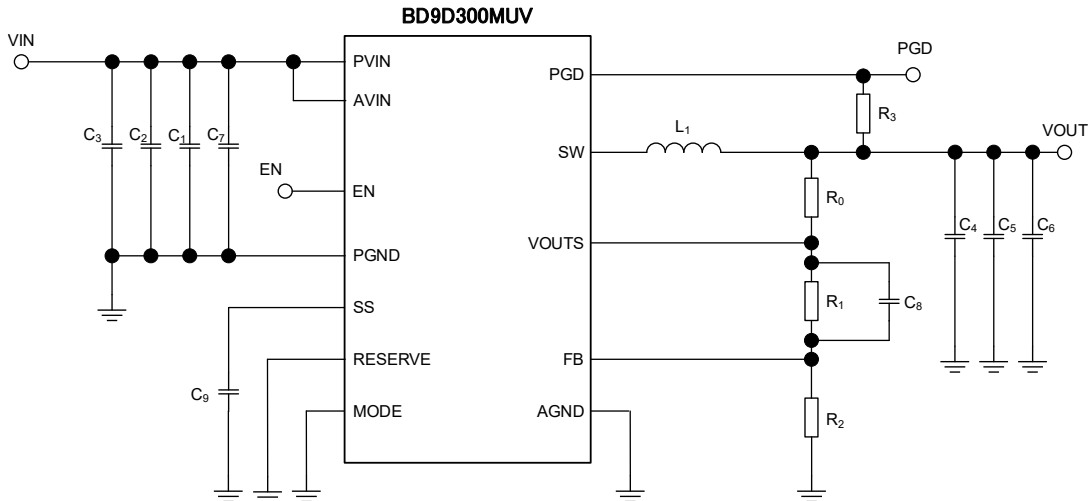

Figure 45. Application Circuit

Table 8. Recommended Component Values (Note 1) ($V_{IN} = 12\text{ V} / V_{OUT} = 3.3\text{ V}$)

Part No.	Value	Part Name	Size (mm)	Manufacturer
L ₁	2.2 μH	FDS0518-H-2R2M	5249	Murata
C ₁ (Note 2)	10 μF (35 V / X5R)	GRM21BR6YA106ME43	2012	Murata
C ₂	-	-	-	-
C ₃	-	-	-	-
C ₄ (Note 3)	47 μF (16 V / X5R)	GRM31CR61C476ME44	3216	Murata
C ₅	-	-	-	-
C ₆	-	-	-	-
C ₇ (Note 4)	0.1 μF (35 V / X5R)	GRM033R6YA104ME14	0603	Murata
C ₈	-	-	-	-
C ₉	-	-	-	-
R ₁	160 k Ω (1 %, 1/16 W)	MCR01MZPF1603	1005	ROHM
R ₂	51 k Ω (1 %, 1/16 W)	MCR01MZPF5102	1005	ROHM
R ₃	100 k Ω (1 %, 1/16 W)	MCR01MZPF1003	1005	ROHM
R ₀ (Note 5)	Short	-	-	-

(Note 1) You agree that this is presented only as guidance for products use. Confirm on the actual equipment considering variations of the characteristics of the product and external components.

(Note 2) For the capacitance of input capacitor, take temperature characteristics, DC bias characteristics, etc. into consideration to set to a minimum value of no less than 2 μF .

(Note 3) In case capacitance value fluctuates due to temperature characteristics, DC bias characteristics, etc. of the output capacitor, loop response characteristics may change. Confirm on the actual equipment. When selecting a capacitor, confirm the characteristics of the capacitor in its datasheet.

(Note 4) In order to reduce the influence of high frequency noise, connect a 0.1 μF ceramic capacitor as close as possible to the PVIN pin and the PGND pin if needed.

(Note 5) R₀ is an option used for feedback's frequency response measurement. By inserting a resistor at R₀, it is possible to measure the frequency response (phase margin) using a FRA. However, the resistor will not be used in actual application, use this resistor pattern in short-circuit mode.

3. $V_{IN} = 12\text{ V} / V_{OUT} = 3.3\text{ V}$ – continued

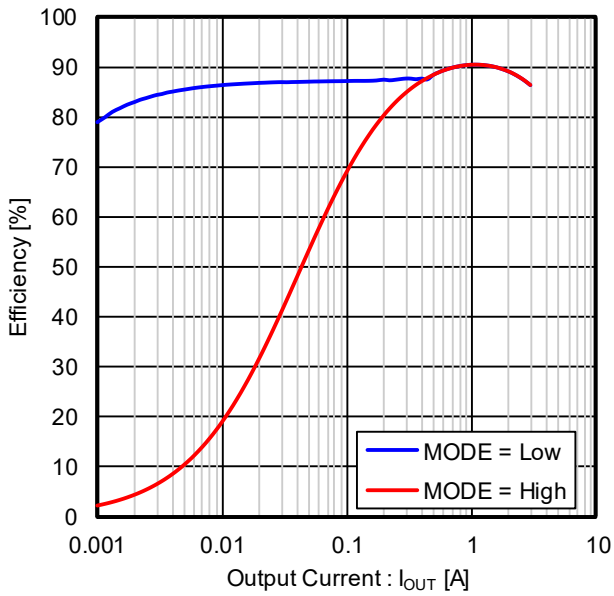

Figure 46. Efficiency vs Output Current

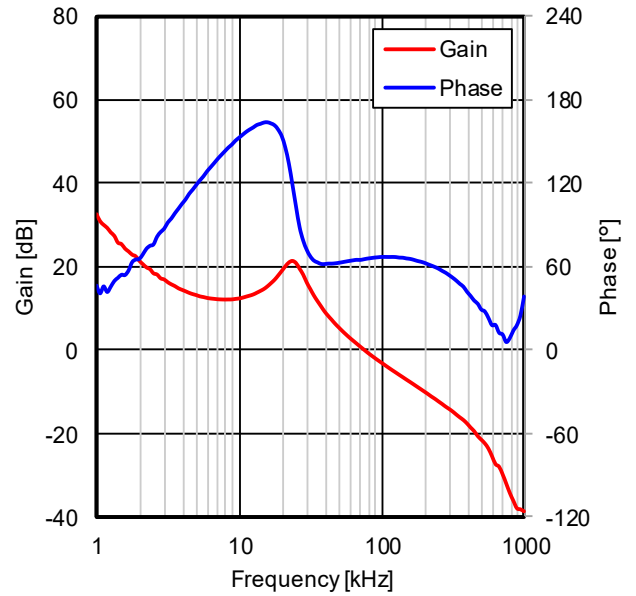

Figure 47. Frequency Characteristics $I_{OUT} = 2.0\text{ A}$

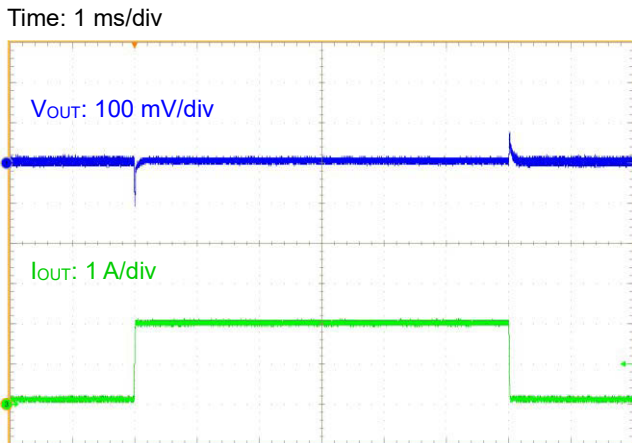

Figure 48. Load Transient Response $I_{OUT} = 0.1\text{ A} - 2.0\text{ A}$ (MODE = Low)

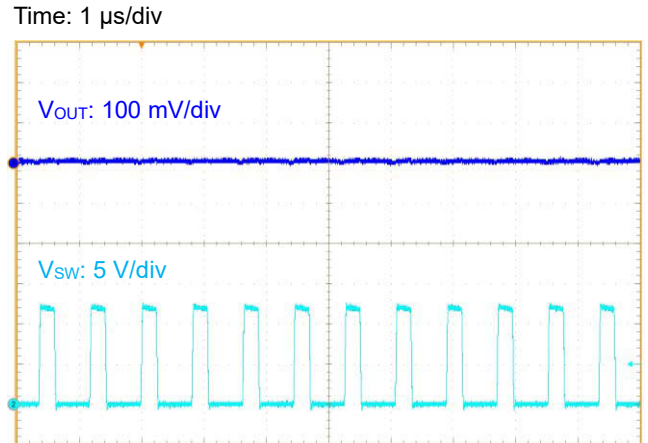

Figure 49. V_{OUT} Ripple $I_{OUT} = 3.0\text{ A}$ (MODE = High)

Application Examples – continued

4. $V_{IN} = 7.4 \text{ V} / V_{OUT} = 3.3 \text{ V}$ Table 9. Specification of Application ($V_{IN} = 7.4 \text{ V} / V_{OUT} = 3.3 \text{ V}$)

Parameter	Symbol	Specification Value
Input Voltage	V_{IN}	7.4 V
Output Voltage	V_{OUT}	3.3 V
Switching Frequency	f_{OSC}	1.25 MHz (Typ)
Maximum Output Current	I_{OUTMAX}	3 A
Operating Temperature	T_a	25 °C

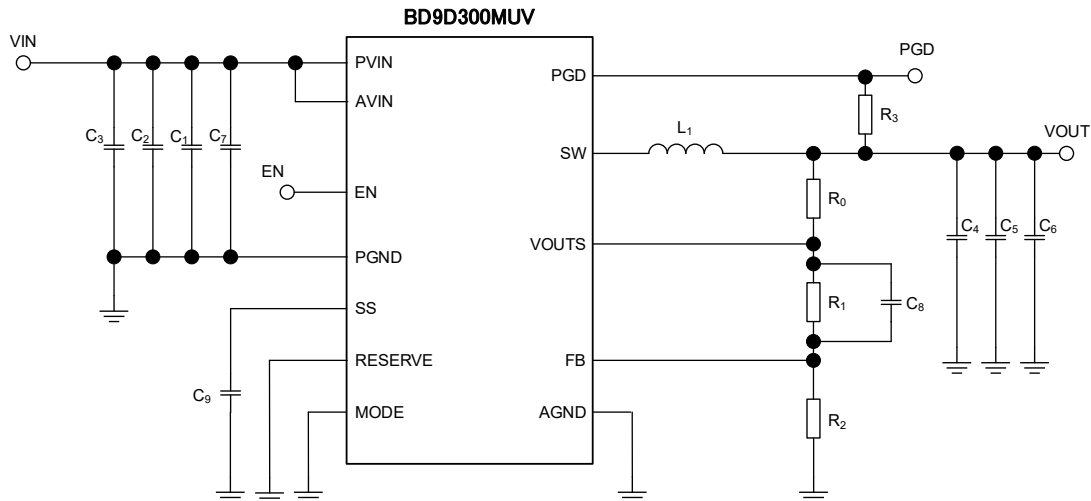

Figure 50. Application Circuit

Table 10. Recommended Component Values ^(Note 1) ($V_{IN} = 7.4 \text{ V} / V_{OUT} = 3.3 \text{ V}$)

Part No.	Value	Part Name	Size (mm)	Manufacturer
L_1	2.2 μH	FDSD0518-H-2R2M	5249	Murata
C_1 ^(Note 2)	10 μF (35 V / X5R)	GRM21BR6YA106ME43	2012	Murata
C_2	-	-	-	-
C_3	-	-	-	-
C_4 ^(Note 3)	47 μF (16 V / X5R)	GRM31CR61C476ME44	3216	Murata
C_5	-	-	-	-
C_6	-	-	-	-
C_7 ^(Note 4)	0.1 μF (35 V / X5R)	GRM033R6YA104ME14	0603	Murata
C_8	-	-	-	-
C_9	-	-	-	-
R_1	160 k Ω (1 %, 1/16 W)	MCR01MZPF1603	1005	ROHM
R_2	51 k Ω (1 %, 1/16 W)	MCR01MZPF5102	1005	ROHM
R_3	100 k Ω (1 %, 1/16 W)	MCR01MZPF1003	1005	ROHM
R_0 ^(Note 5)	Short	-	-	-

(Note 1) You agree that this is presented only as guidance for products use. Confirm on the actual equipment considering variations of the characteristics of the product and external components.

(Note 2) For the capacitance of input capacitor, take temperature characteristics, DC bias characteristics, etc. into consideration to set to a minimum value of no less than 2 μF .

(Note 3) In case capacitance value fluctuates due to temperature characteristics, DC bias characteristics, etc. of the output capacitor, loop response characteristics may change. Confirm on the actual equipment. When selecting a capacitor, confirm the characteristics of the capacitor in its datasheet.

(Note 4) In order to reduce the influence of high frequency noise, connect a 0.1 μF ceramic capacitor as close as possible to the PVIN pin and the PGND pin if needed.

(Note 5) R_0 is an option used for feedback's frequency response measurement. By inserting a resistor at R_0 , it is possible to measure the frequency response (phase margin) using a FRA. However, the resistor will not be used in actual application, use this resistor pattern in short-circuit mode.

4. $V_{IN} = 7.4\text{ V} / V_{OUT} = 3.3\text{ V}$ – continued

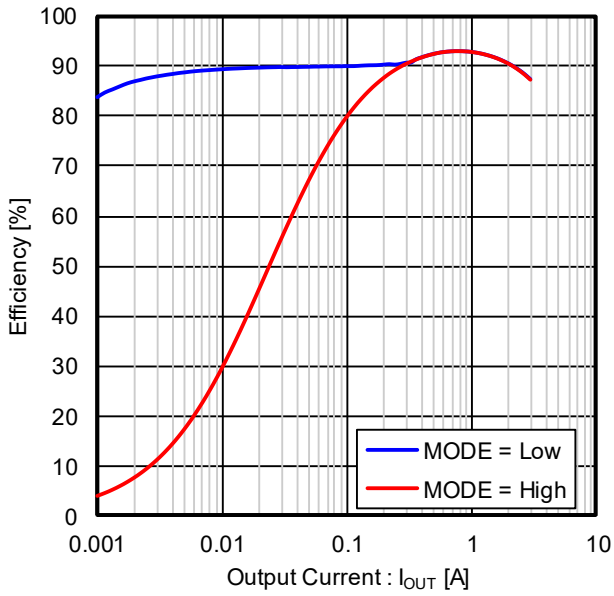

Figure 51. Efficiency vs Output Current

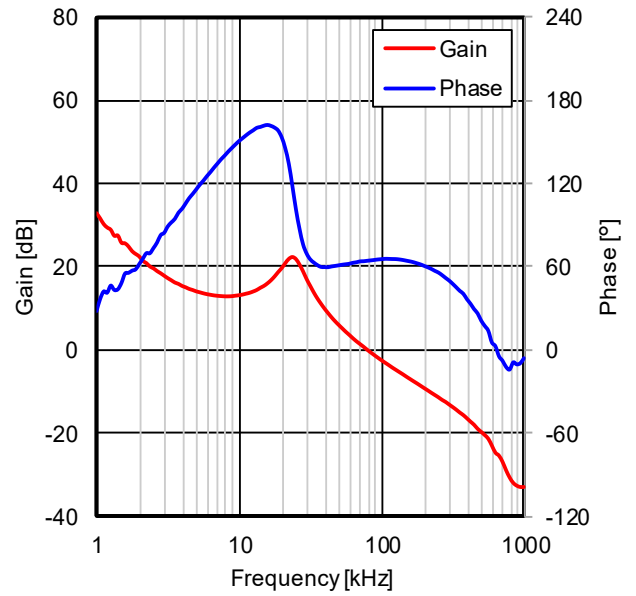

Figure 52. Frequency Characteristics $I_{OUT} = 2.0\text{ A}$

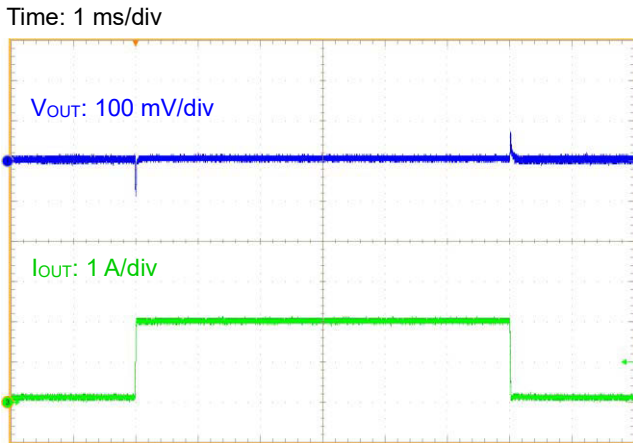

Figure 53. Load Transient Response $I_{OUT} = 0.1\text{ A} - 2.0\text{ A}$ (MODE = Low)

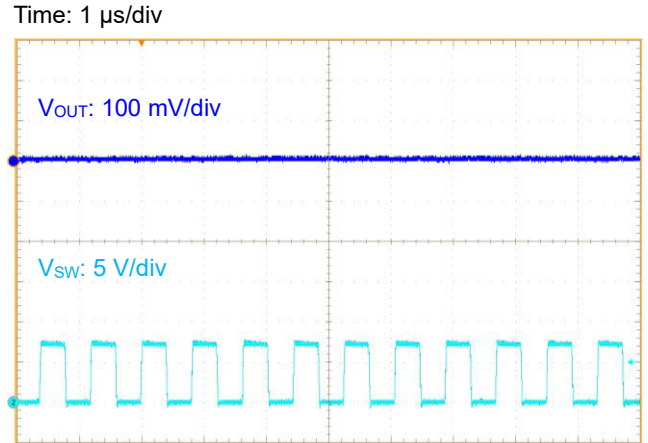

Figure 54. V_{OUT} Ripple $I_{OUT} = 3.0\text{ A}$ (MODE = High)

Application Examples – continued

5. $V_{IN} = 7.4 \text{ V} / V_{OUT} = 1.8 \text{ V}$ Table 11. Specification of Application ($V_{IN} = 7.4 \text{ V} / V_{OUT} = 1.8 \text{ V}$)

Parameter	Symbol	Specification Value
Input Voltage	V_{IN}	7.4 V
Output Voltage	V_{OUT}	1.8 V
Switching Frequency	f_{OSC}	1.25 MHz (Typ)
Maximum Output Current	I_{OUTMAX}	3 A
Operating Temperature	T_a	25 °C

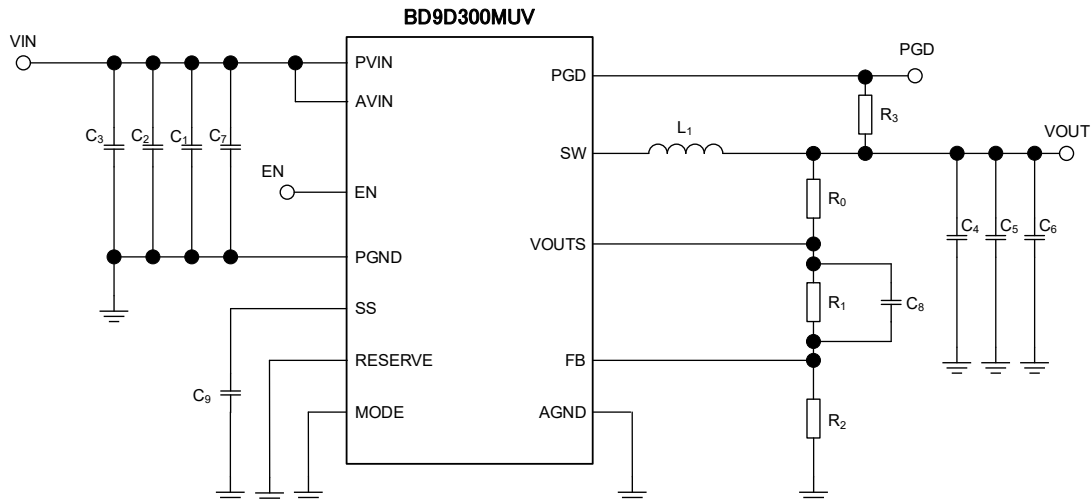

Figure 55. Application Circuit

Table 12. Recommended Component Values (Note 1) ($V_{IN} = 7.4 \text{ V} / V_{OUT} = 1.8 \text{ V}$)

Part No.	Value	Part Name	Size (mm)	Manufacturer
L_1	1.5 μH	FDSD0518-H-1R5M	5249	Murata
C_1 (Note 2)	10 μF (35 V / X5R)	GRM21BR6YA106ME43	2012	Murata
C_2	-	-	-	-
C_3	-	-	-	-
C_4 (Note 3)	47 μF (16 V / X5R)	GRM31CR61C476ME44	3216	Murata
C_5	-	-	-	-
C_6	-	-	-	-
C_7 (Note 4)	0.1 μF (35 V / X5R)	GRM033R6YA104ME14	0603	Murata
C_8	-	-	-	-
C_9	-	-	-	-
R_1	150 k Ω (1 %, 1/16 W)	MCR01MZPF1503	1005	ROHM
R_2	120 k Ω (1 %, 1/16 W)	MCR01MZPF1203	1005	ROHM
R_3	100 k Ω (1 %, 1/16 W)	MCR01MZPF1003	1005	ROHM
R_0 (Note 5)	Short	-	-	-

(Note 1) You agree that this is presented only as guidance for products use. Confirm on the actual equipment considering variations of the characteristics of the product and external components.

(Note 2) For the capacitance of input capacitor, take temperature characteristics, DC bias characteristics, etc. into consideration to set to a minimum value of no less than 2 μF .

(Note 3) In case capacitance value fluctuates due to temperature characteristics, DC bias characteristics, etc. of the output capacitor, loop response characteristics may change. Confirm on the actual equipment. When selecting a capacitor, confirm the characteristics of the capacitor in its datasheet.

(Note 4) In order to reduce the influence of high frequency noise, connect a 0.1 μF ceramic capacitor as close as possible to the PVIN pin and the PGND pin if needed.

(Note 5) R_0 is an option used for feedback's frequency response measurement. By inserting a resistor at R_0 , it is possible to measure the frequency response (phase margin) using a FRA. However, the resistor will not be used in actual application, use this resistor pattern in short-circuit mode.

5. $V_{IN} = 7.4\text{ V} / V_{OUT} = 1.8\text{ V}$ – continued

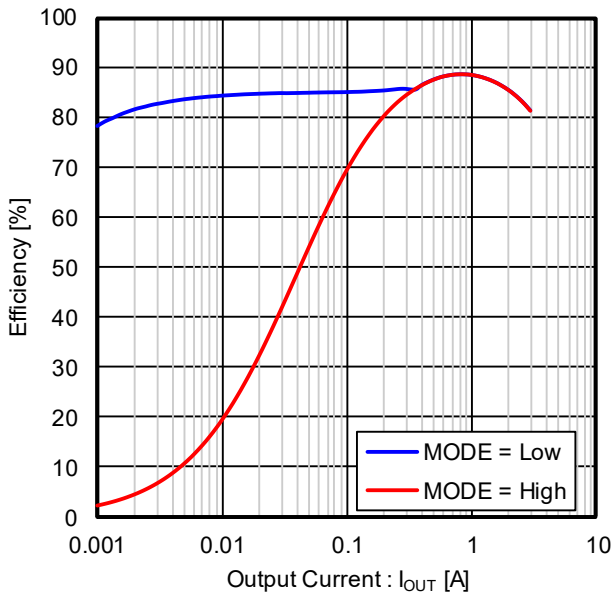

Figure 56. Efficiency vs Output Current

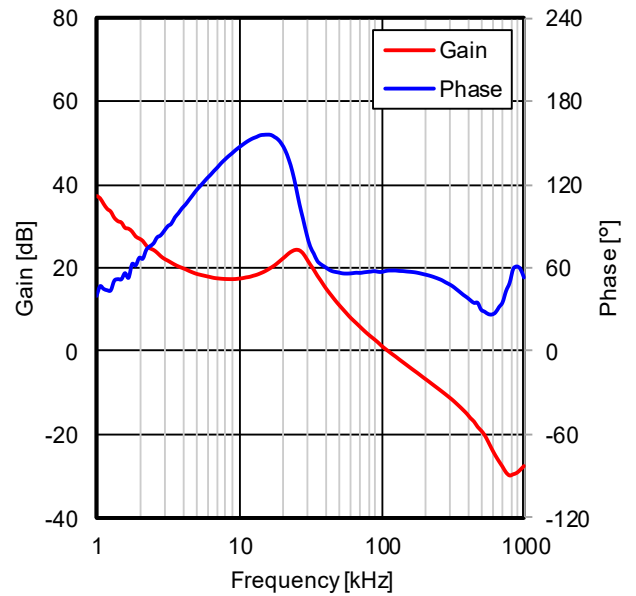

Figure 57. Frequency Characteristics $I_{OUT} = 2.0\text{ A}$

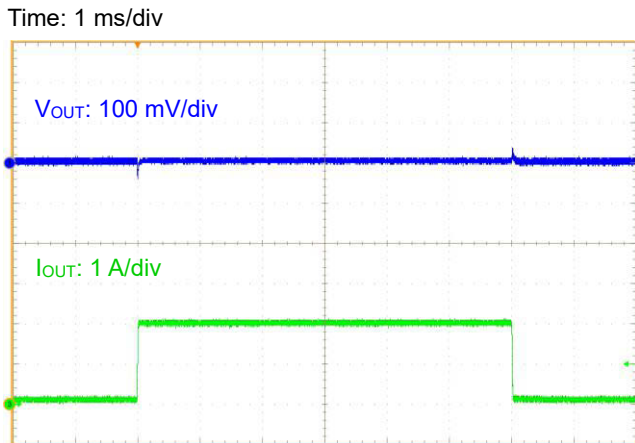

Figure 58. Load Transient Response $I_{OUT} = 0.1\text{ A} - 2.0\text{ A}$ (MODE = Low)

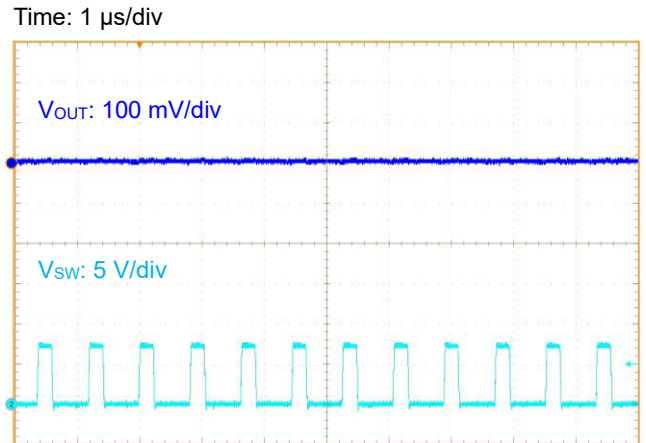

Figure 59. V_{OUT} Ripple $I_{OUT} = 3.0\text{ A}$ (MODE = High)

Application Examples – continued

6. $V_{IN} = 7.4\text{ V} / V_{OUT} = 1.2\text{ V}$

Table 13. Specification of Application ($V_{IN} = 7.4\text{ V} / V_{OUT} = 1.2\text{ V}$)

Parameter	Symbol	Specification Value
Input Voltage	V_{IN}	7.4 V
Output Voltage	V_{OUT}	1.2 V
Switching Frequency	f_{OSC}	1.25 MHz (Typ)
Maximum Output Current	I_{OUTMAX}	3 A
Operating Temperature	T_a	25 °C

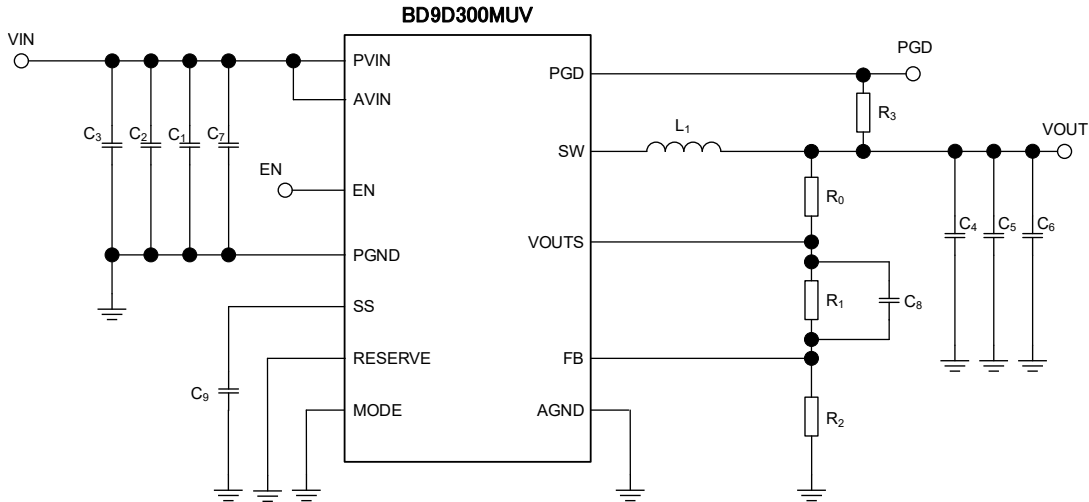

Figure 60. Application Circuit

Table 14. Recommended Component Values (Note 1) ($V_{IN} = 7.4\text{ V} / V_{OUT} = 1.2\text{ V}$)

Part No.	Value	Part Name	Size (mm)	Manufacturer
L_1	1.0 μH	FDSD0518-H-1R0M	5249	Murata
C_1 (Note 2)	10 μF (35 V / X5R)	GRM21BR6YA106ME43	2012	Murata
C_2	-	-	-	-
C_3	-	-	-	-
C_4 (Note 3)	47 μF (16 V / X5R)	GRM31CR61C476ME44	3216	Murata
C_5	-	-	-	-
C_6	-	-	-	-
C_7 (Note 4)	0.1 μF (35 V / X5R)	GRM033R6YA104ME14	0603	Murata
C_8	-	-	-	-
C_9	-	-	-	-
R_1	150 k Ω (1 %, 1/16 W)	MCR01MZPF1503	1005	ROHM
R_2	300 k Ω (1 %, 1/16 W)	MCR01MZPF3003	1005	ROHM
R_3	100 k Ω (1 %, 1/16 W)	MCR01MZPF1003	1005	ROHM
R_0 (Note 5)	Short	-	-	-

(Note 1) You agree that this is presented only as guidance for products use. Confirm on the actual equipment considering variations of the characteristics of the product and external components.

(Note 2) For the capacitance of input capacitor, take temperature characteristics, DC bias characteristics, etc. into consideration to set to a minimum value of no less than 2 μF .

(Note 3) In case capacitance value fluctuates due to temperature characteristics, DC bias characteristics, etc. of the output capacitor, loop response characteristics may change. Confirm on the actual equipment. When selecting a capacitor, confirm the characteristics of the capacitor in its datasheet.

(Note 4) In order to reduce the influence of high frequency noise, connect a 0.1 μF ceramic capacitor as close as possible to the PVIN pin and the PGND pin if needed.

(Note 5) R_0 is an option used for feedback's frequency response measurement. By inserting a resistor at R_0 , it is possible to measure the frequency response (phase margin) using a FRA. However, the resistor will not be used in actual application, use this resistor pattern in short-circuit mode.

6. $V_{IN} = 7.4\text{ V} / V_{OUT} = 1.2\text{ V}$ – continued

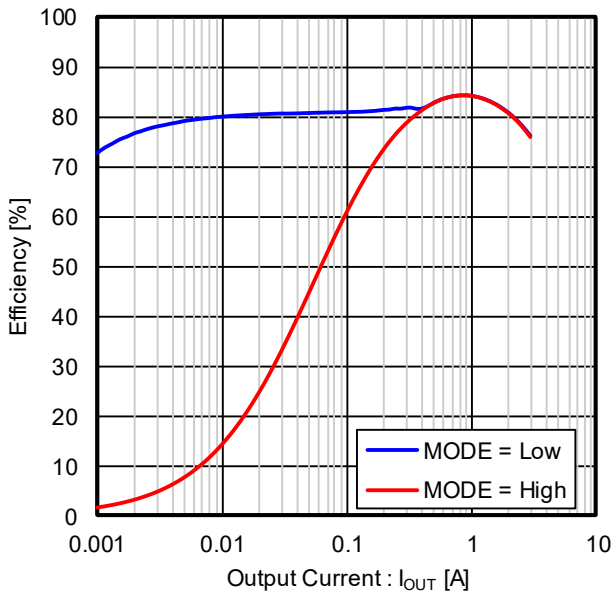

Figure 61. Efficiency vs Output Current

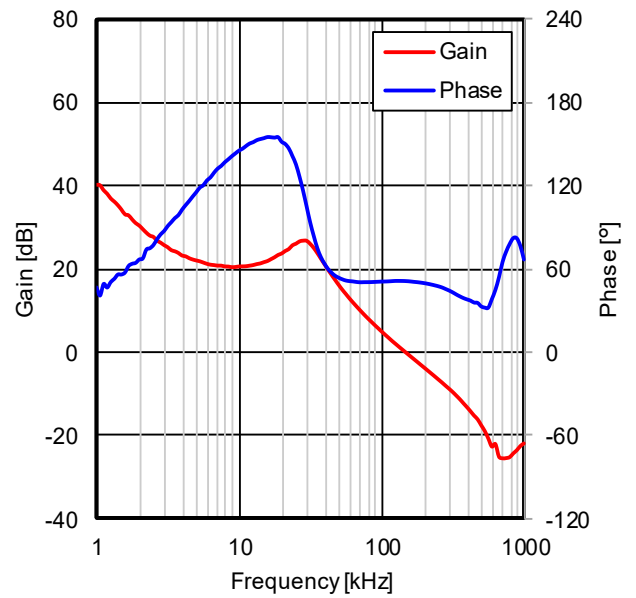

Figure 62. Frequency Characteristics $I_{OUT} = 2.0\text{ A}$

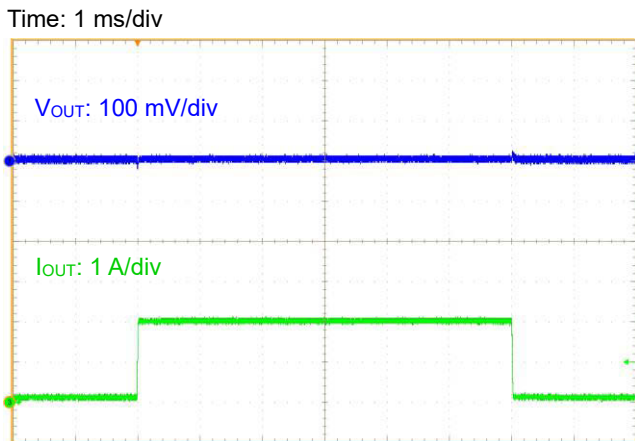

Figure 63. Load Transient Response $I_{OUT} = 0.1\text{ A} - 2.0\text{ A}$ (MODE = Low)

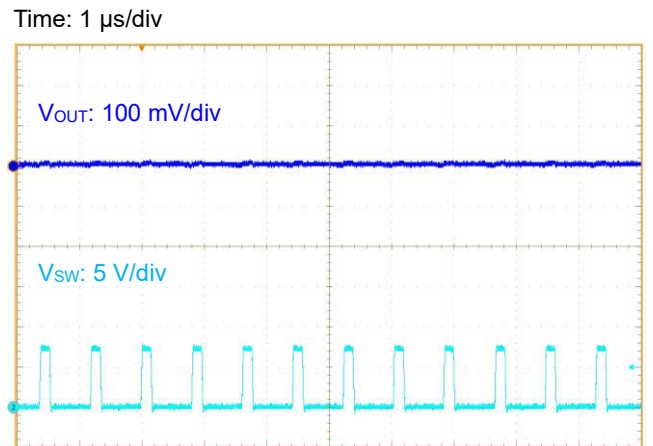

Figure 64. V_{OUT} Ripple $I_{OUT} = 3.0\text{ A}$ (MODE = High)

Selection of Components Externally Connected

Contact us if not use the recommended component values in [Application Examples](#).

1. Output LC Filter

In order to supply a continuous current to the load, the DC/DC converter requires an LC filter for smoothing the output voltage.

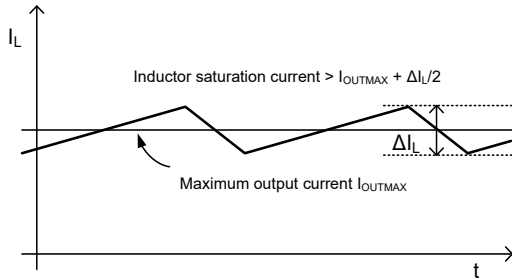

Figure 65. Waveform of current through inductor

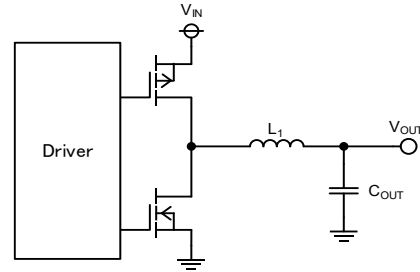

Figure 66. Output LC filter circuit

For example, given that $V_{IN} = 12\text{ V}$, $V_{OUT} = 5.0\text{ V}$, $L_1 = 2.2\ \mu\text{H}$, and the switching frequency $f_{OSC} = 1.25\text{ MHz}$, the inductor ripple current ΔI_L can be calculated as below.

$$\Delta I_L = V_{OUT} \times (V_{IN} - V_{OUT}) \times \frac{1}{V_{IN} \times f_{OSC} \times L_1} = 1061\text{ mA}$$

The inductance value of L_1 is recommended in the range between $1.0\ \mu\text{H}$ and $3.3\ \mu\text{H}$. However, ΔI_L should be set 400 mA or more when using Light Load mode control by the MODE pin connecting to Ground.

The rated current of the inductor (Inductor saturation current) must be larger than the sum of the maximum output current I_{OUTMAX} and 1/2 of the inductor ripple current ΔI_L .

The output capacitor C_{OUT} affects the output ripple voltage characteristics. The capacitance value of C_{OUT} is recommended in the range between $22\ \mu\text{F}$ and $47\ \mu\text{F}$ for stability of the control loop. C_{OUT} must satisfy the required ripple voltage characteristics.

The output ripple voltage ΔV_{RPL} can be estimated by the following equation.

$$\Delta V_{RPL} = \Delta I_L \times \left(R_{ESR} + \frac{1}{8 \times C_{OUT} \times f_{OSC}} \right) [\text{V}]$$

Where:

R_{ESR} is the Equivalent Series Resistance of the output capacitor.

For example, given that $C_{OUT} = 47\ \mu\text{F}$, and $R_{ESR} = 3\ \text{m}\Omega$, ΔV_{RPL} can be calculated as below.

$$\Delta V_{RPL} = 1061\text{ mA} \times \left(3\ \text{m}\Omega + \frac{1}{8 \times 47\ \mu\text{F} \times 1.25\ \text{MHz}} \right) = 5.4\ [\text{mV}]$$

The total capacitance C_{OUTMAX} connected to V_{OUT} needs to satisfy the value obtained by the following equation.

$$C_{OUTMAX} < \frac{t_{SSMIN}}{V_{OUT}} \times \left(3.1 + \frac{\Delta I_L}{2} - I_{OUTSS} \right) [\text{F}]$$

where:

t_{SSMIN} is the minimum soft start time.

V_{OUT} is the output voltage.

ΔI_L is the inductor current.

I_{OUTSS} is the maximum output current during soft start.

For example, given that $V_{IN} = 12\text{ V}$, $V_{OUT} = 5.0\text{ V}$, $L_1 = 2.2\ \mu\text{H}$, $f_{OSC} = 1.25\text{ MHz}$ (Typ), $t_{SSMIN} = 0.4\text{ ms}$ ($C_{SS} = \text{OPEN}$), and $I_{OUTSS} = 3\text{ A}$, C_{OUTMAX} can be calculated as below.

$$C_{OUTMAX} < \frac{0.4\ \text{ms}}{5.0\ \text{V}} \times \left(3.1 + \frac{1061\ \text{mA}}{2} - 3.0\ \text{A} \right) = 50.4\ [\mu\text{F}]$$

If the total capacitance connected to V_{OUT} is larger than C_{OUTMAX} , over current protection may be activated by the inrush current at start-up and prevented to turn on the output. In addition, C_{OUT} affects the load transient response and stability of the control loop. Confirm it on the actual application.

Selection of Components Externally Connected – continued

2. Output Voltage Setting

The output voltage value can be set by the feedback resistance ratio.

For stable operation, use feedback resistance R_1 of value from 100 k Ω to 300 k Ω .

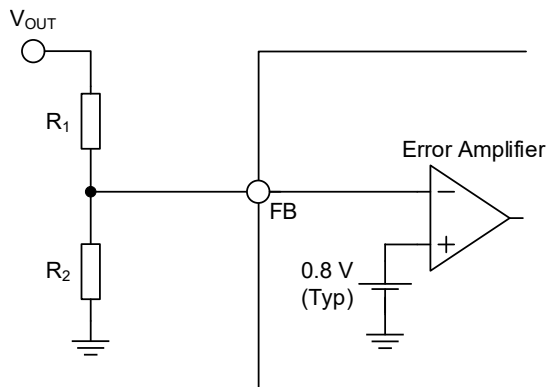

$$V_{OUT} = \frac{R_1 + R_2}{R_2} \times V_{FB} \text{ [V]}$$

$$R_2 = \frac{V_{FB}}{V_{OUT} - V_{FB}} \times R_1 \text{ [\Omega]}$$

Figure 67. Feedback Resistor Circuit

3. Soft Start Capacitor (Soft Start Time Setting)

The soft start time t_{SS} depends on the value of the capacitor connected to the SS pin. t_{SS} is 1 ms (Typ) when the SS pin is left floating. The capacitor connected to the SS pin makes t_{SS} more than 1 ms. The t_{SS} and C_{SS} can be calculated using below equation. The C_{SS} should be set in the range between 3300 pF and 0.1 μ F.

$$t_{SS} = \frac{(C_{SS} \times V_{SS})}{I_{SS}}$$

Where:

t_{SS} is the soft start time.

C_{SS} is the capacitor connected to the SS pin.

V_{SS} is the SS voltage finished soft start function. 1.2 V (Typ) \times 0.95 (Typ)

I_{SS} is the soft start current. 2.5 μ A (Typ)

With $C_{SS} = 0.01 \mu$ F, t_{SS} can be calculated as below.

$$t_{SS} = \frac{(0.01 \mu\text{F} \times 1.2 \text{ V} \times 0.95)}{2.5 \mu\text{A}} = 4.56 \text{ ms}$$

PCB Layout Design

PCB layout design for DC/DC converter power supply IC is as important as the circuit design. Appropriate layout can avoid various problems caused by power supply circuit. Figure 68-a to Figure 68-c show the current path in a buck converter circuit. The Loop1 in Figure 68-a is a current path when H-side switch is ON and L-side switch is OFF and the Loop2 in Figure 68-b is when H-side switch is OFF and L-side switch is ON. The thick line in Figure 68-c shows the difference between Loop1 and Loop2. The current in thick line changes sharply each time the switching element H-side and L-side switch change from OFF to ON, and vice versa. These sharp changes induce several harmonics in the waveform. Therefore, the loop area of thick line that is consisted by input capacitor and IC should be as small as possible to minimize noise. For more detail, refer to application note of switching regulator series “PCB Layout Techniques of Buck Converter”.

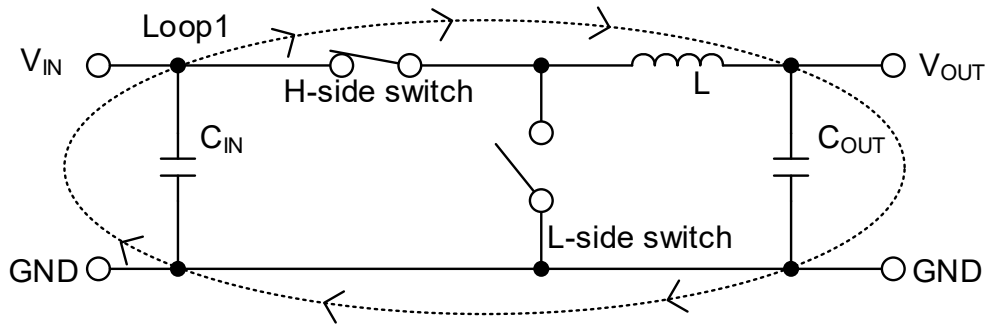

Figure 68-a. Current Path when H-side Switch = ON, L-side Switch = OFF

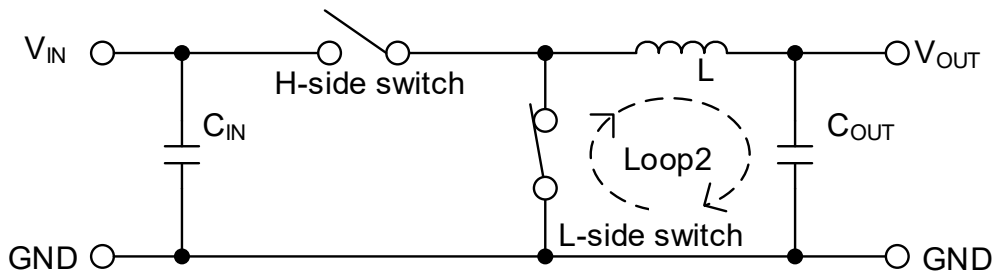

Figure 68-b. Current Path when H-side Switch = OFF, L-side Switch = ON

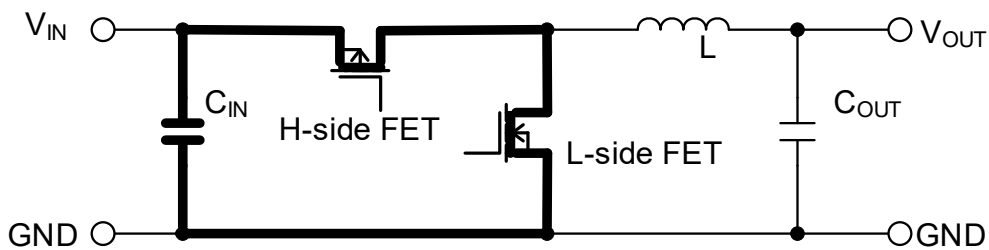
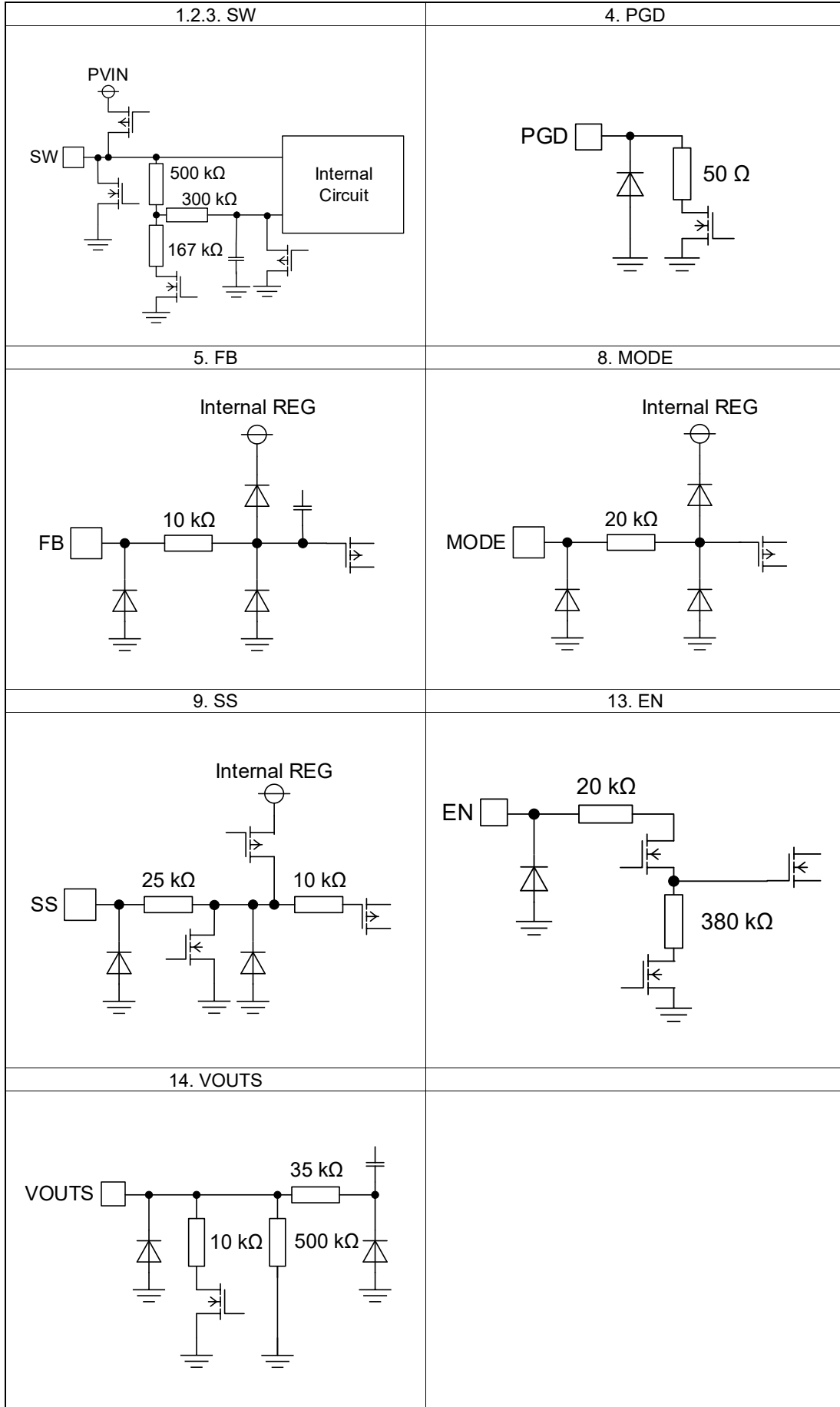

Figure 68-c. Difference of Current and Critical Area in Layout

I/O Equivalence Circuits



Operational Notes

1. Reverse Connection of Power Supply

Connecting the power supply in reverse polarity can damage the IC. Take precautions against reverse polarity when connecting the power supply, such as mounting an external diode between the power supply and the IC's power supply pins.

2. Power Supply Lines

Design the PCB layout pattern to provide low impedance supply lines. Separate the ground and supply lines of the digital and analog blocks to prevent noise in the ground and supply lines of the digital block from affecting the analog block. Furthermore, connect a capacitor to ground at all power supply pins. Consider the effect of temperature and aging on the capacitance value when using electrolytic capacitors.

3. Ground Voltage

Ensure that no pins are at a voltage below that of the ground pin at any time, even during transient condition. However, pins that drive inductive loads (e.g. motor driver outputs, DC-DC converter outputs) may inevitably go below ground due to back EMF or electromotive force. In such cases, the user should make sure that such voltages going below ground will not cause the IC and the system to malfunction by examining carefully all relevant factors and conditions such as motor characteristics, supply voltage, operating frequency and PCB wiring to name a few.

4. Ground Wiring Pattern

When using both small-signal and large-current ground traces, the two ground traces should be routed separately but connected to a single ground at the reference point of the application board to avoid fluctuations in the small-signal ground caused by large currents. Also ensure that the ground traces of external components do not cause variations on the ground voltage. The ground lines must be as short and thick as possible to reduce line impedance.

5. Recommended Operating Conditions

The function and operation of the IC are guaranteed within the range specified by the recommended operating conditions. The characteristic values are guaranteed only under the conditions of each item specified by the electrical characteristics.

6. Inrush Current

When power is first supplied to the IC, it is possible that the internal logic may be unstable and inrush current may flow instantaneously due to the internal powering sequence and delays, especially if the IC has more than one power supply. Therefore, give special consideration to power coupling capacitance, power wiring, width of ground wiring, and routing of connections.

7. Testing on Application Boards

When testing the IC on an application board, connecting a capacitor directly to a low-impedance output pin may subject the IC to stress. Always discharge capacitors completely after each process or step. The IC's power supply should always be turned off completely before connecting or removing it from the test setup during the inspection process. To prevent damage from static discharge, ground the IC during assembly and use similar precautions during transport and storage.

8. Inter-pin Short and Mounting Errors

Ensure that the direction and position are correct when mounting the IC on the PCB. Incorrect mounting may result in damaging the IC. Avoid nearby pins being shorted to each other especially to ground, power supply and output pin. Inter-pin shorts could be due to many reasons such as metal particles, water droplets (in very humid environment) and unintentional solder bridge deposited in between pins during assembly to name a few.

9. Unused Input Pins

Input pins of an IC are often connected to the gate of a MOS transistor. The gate has extremely high impedance and extremely low capacitance. If left unconnected, the electric field from the outside can easily charge it. The small charge acquired in this way is enough to produce a significant effect on the conduction through the transistor and cause unexpected operation of the IC. So unless otherwise specified, unused input pins should be connected to the power supply or ground line.

Operation Notes – continued

10. Regarding the Input Pin of the IC

This monolithic IC contains P+ isolation and P substrate layers between adjacent elements in order to keep them isolated. P-N junctions are formed at the intersection of the P layers with the N layers of other elements, creating a parasitic diode or transistor. For example (refer to figure below):

When $GND > Pin A$ and $GND > Pin B$, the P-N junction operates as a parasitic diode.

When $GND > Pin B$, the P-N junction operates as a parasitic transistor.

Parasitic diodes inevitably occur in the structure of the IC. The operation of parasitic diodes can result in mutual interference among circuits, operational faults, or physical damage. Therefore, conditions that cause these diodes to operate, such as applying a voltage lower than the GND voltage to an input pin (and thus to the P substrate) should be avoided.

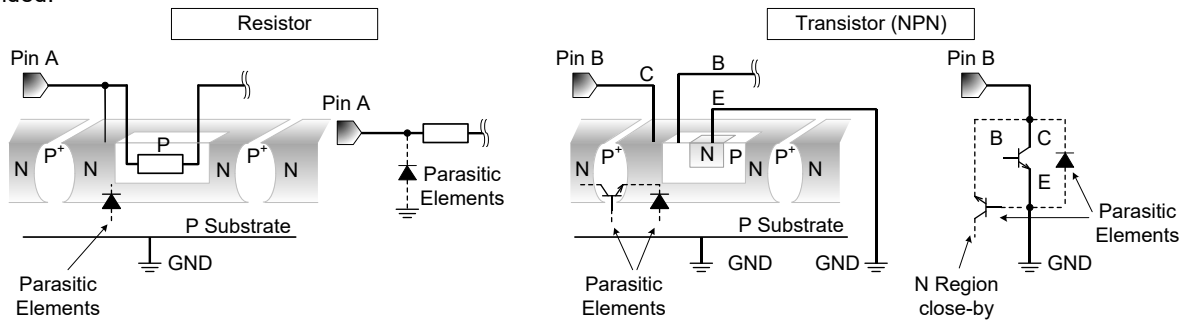

Figure 69. Example of Monolithic IC Structure

11. Ceramic Capacitor

When using a ceramic capacitor, determine a capacitance value considering the change of capacitance with temperature and the decrease in nominal capacitance due to DC bias and others.

12. Thermal Shutdown Circuit(TSD)

This IC has a built-in thermal shutdown circuit that prevents heat damage to the IC. Normal operation should always be within the IC's maximum junction temperature rating. If however the rating is exceeded for a continued period, the junction temperature (T_j) will rise which will activate the TSD circuit that will turn OFF power output pins. When the T_j falls below the TSD threshold, the circuits are automatically restored to normal operation.

Note that the TSD circuit operates in a situation that exceeds the absolute maximum ratings and therefore, under no circumstances, should the TSD circuit be used in a set design or for any purpose other than protecting the IC from heat damage.

13. Over Current Protection Circuit (OCP)

This IC incorporates an integrated overcurrent protection circuit that is activated when the load is shorted. This protection circuit is effective in preventing damage due to sudden and unexpected incidents. However, the IC should not be used in applications characterized by continuous operation or transitioning of the protection circuit.

Ordering Information

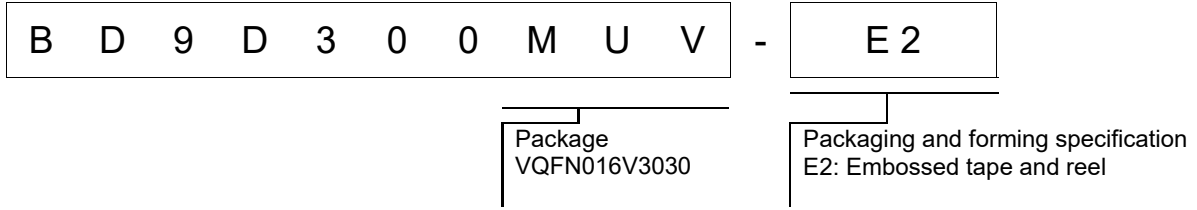

Marking Diagram

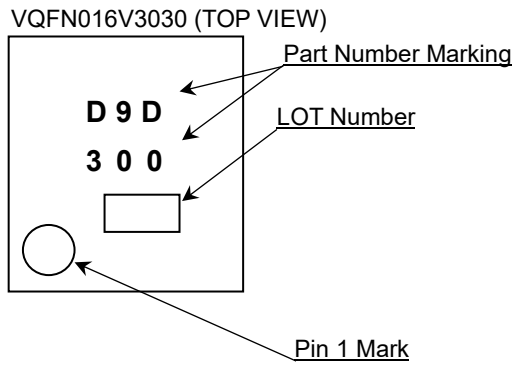

Physical Dimension and Packing Information

Package Name	VQFN016V3030
--------------	--------------

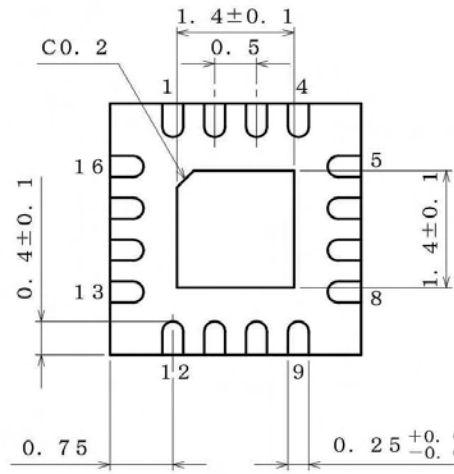
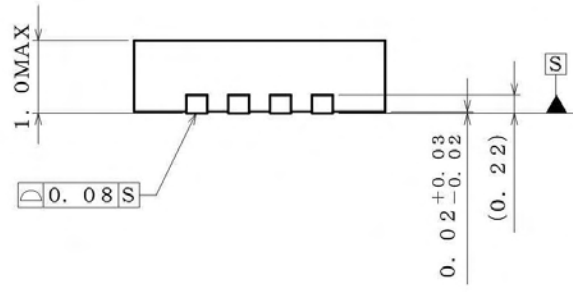
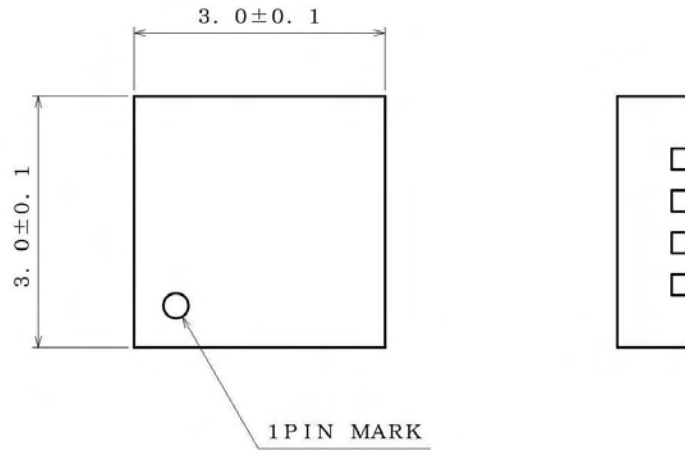

(UNIT : mm)
 PKG : VQFN016V3030
 Drawing No. EX460-5001-2

<Tape and Reel information>

Tape	Embossed carrier tape
Quantity	3000pcs
Direction of feed	E2 (The direction is the 1pin of product is at the upper left when you hold reel on the left hand and you pull out the tape on the right hand)

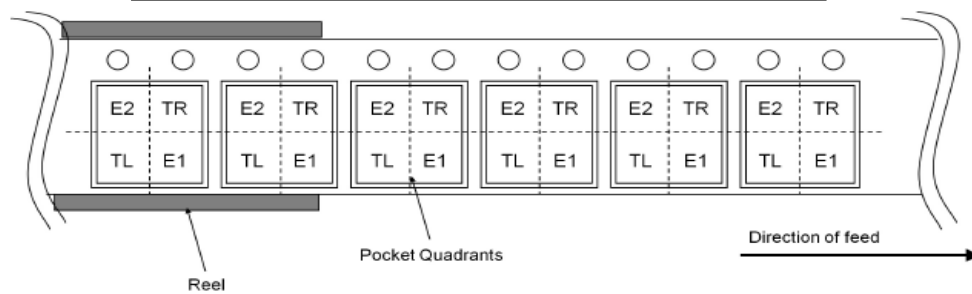

Revision History

Date	Revision	Changes
18.Mar.2019	001	New Release
16.Sep.2021	002	P4 Consist Soft Start block explanation with Japanese version. P6 Correct of Output Voltage Setting symbol error in Recommended Operating Condition P6 Correct of Output OVP Release Voltage symbol error in Electrical Characteristics P7 Correct of Figure 3 MODE setting error in Typical Performance Curves

Notice

Precaution on using ROHM Products

- Our Products are designed and manufactured for application in ordinary electronic equipment (such as AV equipment, OA equipment, telecommunication equipment, home electronic appliances, amusement equipment, etc.). If you intend to use our Products in devices requiring extremely high reliability (such as medical equipment ^(Note 1), transport equipment, traffic equipment, aircraft/spacecraft, nuclear power controllers, fuel controllers, car equipment including car accessories, safety devices, etc.) and whose malfunction or failure may cause loss of human life, bodily injury or serious damage to property ("Specific Applications"), please consult with the ROHM sales representative in advance. Unless otherwise agreed in writing by ROHM in advance, ROHM shall not be in any way responsible or liable for any damages, expenses or losses incurred by you or third parties arising from the use of any ROHM's Products for Specific Applications.

(Note1) Medical Equipment Classification of the Specific Applications

JAPAN	USA	EU	CHINA
CLASS III	CLASS III	CLASS II b	CLASS III
CLASS IV		CLASS III	

- ROHM designs and manufactures its Products subject to strict quality control system. However, semiconductor products can fail or malfunction at a certain rate. Please be sure to implement, at your own responsibilities, adequate safety measures including but not limited to fail-safe design against the physical injury, damage to any property, which a failure or malfunction of our Products may cause. The following are examples of safety measures:
 - Installation of protection circuits or other protective devices to improve system safety
 - Installation of redundant circuits to reduce the impact of single or multiple circuit failure
- Our Products are designed and manufactured for use under standard conditions and not under any special or extraordinary environments or conditions, as exemplified below. Accordingly, ROHM shall not be in any way responsible or liable for any damages, expenses or losses arising from the use of any ROHM's Products under any special or extraordinary environments or conditions. If you intend to use our Products under any special or extraordinary environments or conditions (as exemplified below), your independent verification and confirmation of product performance, reliability, etc. prior to use, must be necessary:
 - Use of our Products in any types of liquid, including water, oils, chemicals, and organic solvents
 - Use of our Products outdoors or in places where the Products are exposed to direct sunlight or dust
 - Use of our Products in places where the Products are exposed to sea wind or corrosive gases, including Cl₂, H₂S, NH₃, SO₂, and NO₂
 - Use of our Products in places where the Products are exposed to static electricity or electromagnetic waves
 - Use of our Products in proximity to heat-producing components, plastic cords, or other flammable items
 - Sealing or coating our Products with resin or other coating materials
 - Use of our Products without cleaning residue of flux (Exclude cases where no-clean type fluxes is used. However, recommend sufficiently about the residue.) ; or Washing our Products by using water or water-soluble cleaning agents for cleaning residue after soldering
 - Use of the Products in places subject to dew condensation
- The Products are not subject to radiation-proof design.
- Please verify and confirm characteristics of the final or mounted products in using the Products.
- In particular, if a transient load (a large amount of load applied in a short period of time, such as pulse, is applied, confirmation of performance characteristics after on-board mounting is strongly recommended. Avoid applying power exceeding normal rated power; exceeding the power rating under steady-state loading condition may negatively affect product performance and reliability.
- De-rate Power Dissipation depending on ambient temperature. When used in sealed area, confirm that it is the use in the range that does not exceed the maximum junction temperature.
- Confirm that operation temperature is within the specified range described in the product specification.
- ROHM shall not be in any way responsible or liable for failure induced under deviant condition from what is defined in this document.

Precaution for Mounting / Circuit board design

- When a highly active halogenous (chlorine, bromine, etc.) flux is used, the residue of flux may negatively affect product performance and reliability.
- In principle, the reflow soldering method must be used on a surface-mount products, the flow soldering method must be used on a through hole mount products. If the flow soldering method is preferred on a surface-mount products, please consult with the ROHM representative in advance.

For details, please refer to ROHM Mounting specification

Precautions Regarding Application Examples and External Circuits

1. If change is made to the constant of an external circuit, please allow a sufficient margin considering variations of the characteristics of the Products and external components, including transient characteristics, as well as static characteristics.
2. You agree that application notes, reference designs, and associated data and information contained in this document are presented only as guidance for Products use. Therefore, in case you use such information, you are solely responsible for it and you must exercise your own independent verification and judgment in the use of such information contained in this document. ROHM shall not be in any way responsible or liable for any damages, expenses or losses incurred by you or third parties arising from the use of such information.

Precaution for Electrostatic

This Product is electrostatic sensitive product, which may be damaged due to electrostatic discharge. Please take proper caution in your manufacturing process and storage so that voltage exceeding the Products maximum rating will not be applied to Products. Please take special care under dry condition (e.g. Grounding of human body / equipment / solder iron, isolation from charged objects, setting of ionizer, friction prevention and temperature / humidity control).

Precaution for Storage / Transportation

1. Product performance and soldered connections may deteriorate if the Products are stored in the places where:
 - [a] the Products are exposed to sea winds or corrosive gases, including Cl₂, H₂S, NH₃, SO₂, and NO₂
 - [b] the temperature or humidity exceeds those recommended by ROHM
 - [c] the Products are exposed to direct sunshine or condensation
 - [d] the Products are exposed to high Electrostatic
2. Even under ROHM recommended storage condition, solderability of products out of recommended storage time period may be degraded. It is strongly recommended to confirm solderability before using Products of which storage time is exceeding the recommended storage time period.
3. Store / transport cartons in the correct direction, which is indicated on a carton with a symbol. Otherwise bent leads may occur due to excessive stress applied when dropping of a carton.
4. Use Products within the specified time after opening a humidity barrier bag. Baking is required before using Products of which storage time is exceeding the recommended storage time period.

Precaution for Product Label

A two-dimensional barcode printed on ROHM Products label is for ROHM's internal use only.

Precaution for Disposition

When disposing Products please dispose them properly using an authorized industry waste company.

Precaution for Foreign Exchange and Foreign Trade act

Since concerned goods might be fallen under listed items of export control prescribed by Foreign exchange and Foreign trade act, please consult with ROHM in case of export.

Precaution Regarding Intellectual Property Rights

1. All information and data including but not limited to application example contained in this document is for reference only. ROHM does not warrant that foregoing information or data will not infringe any intellectual property rights or any other rights of any third party regarding such information or data.
2. ROHM shall not have any obligations where the claims, actions or demands arising from the combination of the Products with other articles such as components, circuits, systems or external equipment (including software).
3. No license, expressly or implied, is granted hereby under any intellectual property rights or other rights of ROHM or any third parties with respect to the Products or the information contained in this document. Provided, however, that ROHM will not assert its intellectual property rights or other rights against you or your customers to the extent necessary to manufacture or sell products containing the Products, subject to the terms and conditions herein.

Other Precaution

1. This document may not be reprinted or reproduced, in whole or in part, without prior written consent of ROHM.
2. The Products may not be disassembled, converted, modified, reproduced or otherwise changed without prior written consent of ROHM.
3. In no event shall you use in any way whatsoever the Products and the related technical information contained in the Products or this document for any military purposes, including but not limited to, the development of mass-destruction weapons.
4. The proper names of companies or products described in this document are trademarks or registered trademarks of ROHM, its affiliated companies or third parties.

General Precaution

1. Before you use our Products, you are requested to carefully read this document and fully understand its contents. ROHM shall not be in any way responsible or liable for failure, malfunction or accident arising from the use of any ROHM's Products against warning, caution or note contained in this document.
2. All information contained in this document is current as of the issuing date and subject to change without any prior notice. Before purchasing or using ROHM's Products, please confirm the latest information with a ROHM sales representative.
3. The information contained in this document is provided on an "as is" basis and ROHM does not warrant that all information contained in this document is accurate and/or error-free. ROHM shall not be in any way responsible or liable for any damages, expenses or losses incurred by you or third parties resulting from inaccuracy or errors of or concerning such information.