



**Key-operated actuators, Flat Front, not suitable for master key systems, 2 positions, momentary, MS5**

**Part no.** M30C-FWS-MS5  
**Catalog No.** 187075  
**Eaton Catalog No.** M30C-FWS-MS5

**Delivery program**

Product range			RMQ-Titan
Basic function			Key-operated buttons
Single unit/Complete unit			Single unit
Design			key operation lock mechanism momentary
<b>Function:</b>			
			↳ 40°
			Not suitable for master key systems
			2 positions
Lock mechanism			MS5
<b>Key withdrawable in position</b>			
			0
Degree of Protection			IP64
Front ring			Metal bezel
Connection to SmartWire-DT			Yes, with SWD-RMQ connections
<b>Actuator travel and actuation force as per DIN EN 60947-5-1, K.5.4.1</b>			
Minimum force for positive opening	N		0
Front dimensions			Ø 36 mm
<b>Instructions</b>			Stay-put/spring-return function, can be changed with coding parts M22-XC-Y Key withdraw convertible with coding adapters M22-XC-...
Information about equipment supplied			With 1 key

**Technical data**

<b>General</b>			
Standards			IEC/EN 60947 VDE 0660
Lifespan, mechanical	Operations	x 10 <sup>6</sup>	> 0.1
Operating frequency	Operations/h		≡ 100
Operating torque		Nm	≡ 0.5
Climatic proofing			Damp heat, constant, to IEC 60068-2-78 Damp heat, cyclic, to IEC 60068-2-30
Degree of Protection			IP64
Ambient temperature			
Open		°C	-25 - +70
Mounting position			As required
Mechanical shock resistance		g	15 Shock duration 11 ms Sinusoidal according to IEC 60068-2-27

**Design verification as per IEC/EN 61439**

Technical data for design verification			
Operating ambient temperature max.		°C	-25
Operating ambient temperature max.		°C	70

**Technical data ETIM 6.0**

Low-voltage industrial components (EG000017) / Front element for selector switch (EC000222)

Number of switch positions			2
Type of control element			Key
Suitable for illumination			No
Colour control element			Black
Colour indicator light cap			Not applicable
Construction type lens			Round
Hole diameter	mm		30
Width opening	mm		0
Height meter opening	mm		0
Switching function latching			No
Spring-return			Yes
Degree of protection (IP), front side			IP66
With front ring			Yes
Material front ring			Metal
Colour front ring			Chrome

## Dimensions

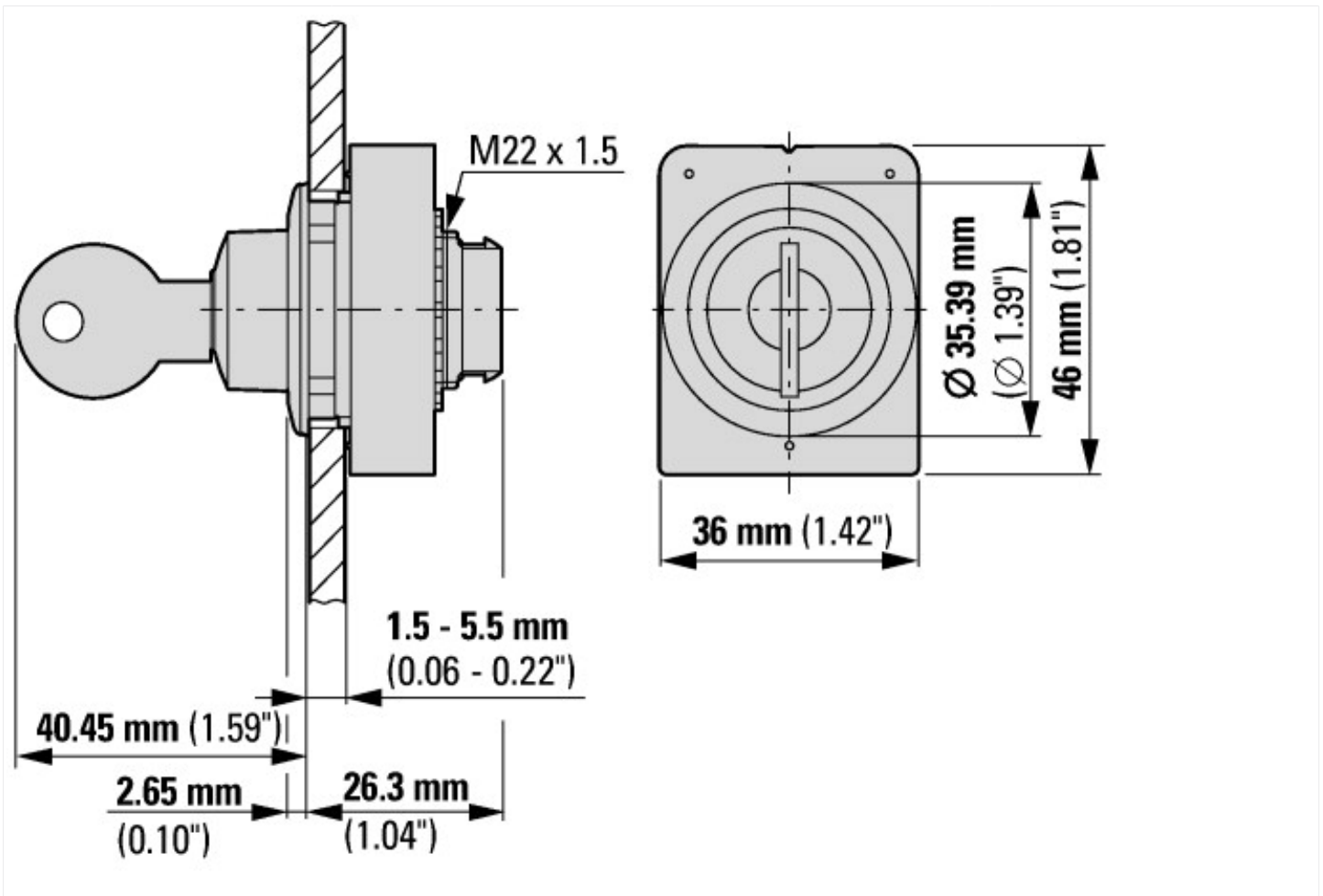



with 2 M22-K... standard contact elements



with M22-FK... flat rear contact elements



### Additional product information (links)

IL047019ZU Flat Front

IL047019ZU Flat Front

[ftp://ftp.moeller.net/DOCUMENTATION/AWA\\_INSTRUCTIONS/IL047019ZU2017\\_02.pdf](ftp://ftp.moeller.net/DOCUMENTATION/AWA_INSTRUCTIONS/IL047019ZU2017_02.pdf)