

E11697

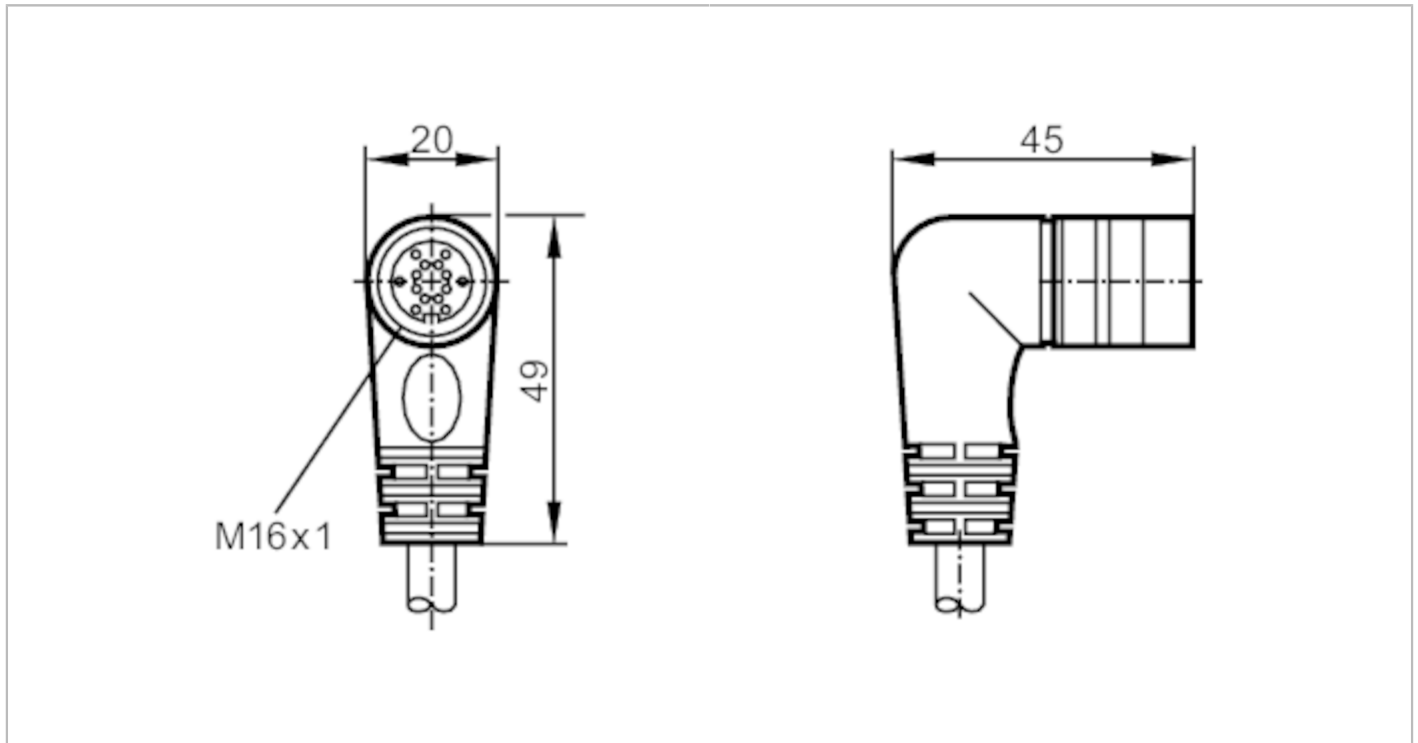

Connecting cable with socket

ADOAO140MSS0005B11



Electrical data

Operating voltage	[V]	< 30 DC
Max. current load total	[A]	3

Operating conditions

Ambient temperature	[°C]	-25...90
Protection		IP 67

Mechanical data

Weight	[g]	421.5
Dimensions	[mm]	45 x 20 x 49
Materials		PUR
Material nut		brass, nickel-plated

Remarks

Pack quantity		1 pcs.
---------------	--	--------

Electrical connection

Cable: 5 m, PUR, black, Ø 7.5 mm; 2 x 0.34 mm² (14 x Ø 0.15 mm) + 9 x 0.25 mm² (7 x Ø 0.2 mm)

Electrical connection - socket

Connector: 1 x M16, angled; Moulded body: PUR; Locking: brass, nickel-plated

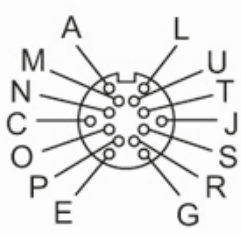

E11697



Connecting cable with socket

AD0AO140MSS0005B11

Connection

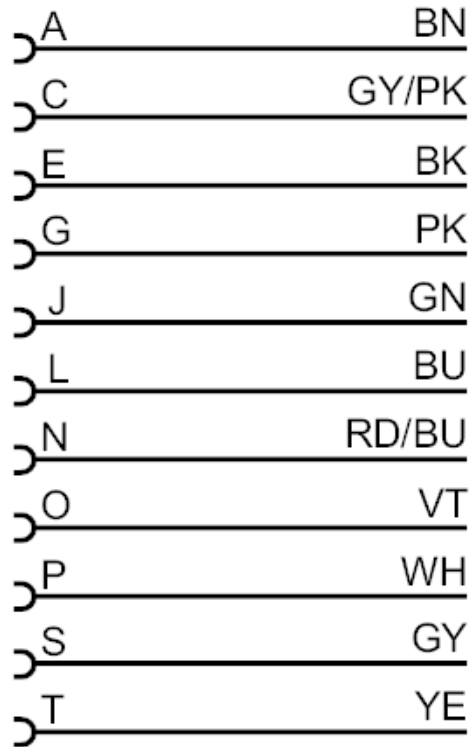

M: not used

R: not used

U: not used

Core colours :

BK = black

BN = brown

BU = blue

GN = green

GY = grey

PK = pink

VT = lilac

WH = white

YE = yellow