

SEMI-COND. CONTACTOR 3RF2,1-PH. AC 51 20 A
40 DEGREES C 48-460 V / 110-230 V AC SHORT-
CIRC. RESIST. WITH B-MCB

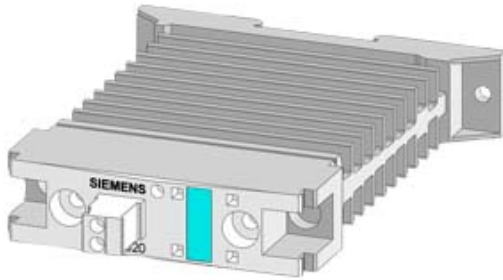

General technical data:		
product brand name		SIRIUS
Product designation		solid-state contactor
Product function		short-circuit resistant with B-automatic device
Number of poles for main current circuit		1
Protection class IP		IP20
Product designation _1 of the accessories that can be ordered		terminal cover
Manufacturer article number _1 of the accessories that can be ordered		3RF2900-3PA88
Product designation _4 of the accessories that can be ordered		load monitoring
Manufacturer article number _4 of the accessories that can be ordered		3RF2920-0GA36
Ambient temperature		
• during operation	°C	-25 ... +60
• during storage	°C	-55 ... +80
Installation altitude at height above sea level maximum	m	1 000
Vibration resistance acc. to IEC 60068-2-6		2g
Shock resistance acc. to IEC 60068-2-27		15g / 11 ms
Equipment marking acc. to DIN 40719 extended according to IEC 204-2 acc. to IEC 750		K
Equipment marking acc. to DIN EN 61346-2		Q
Number of NC contacts for auxiliary contacts		0
Number of NO contacts for auxiliary contacts		0

Number of CO contacts for auxiliary contacts		0
--	--	---

Main circuit:

Number of NO contacts for main contacts		1
Number of NC contacts for main contacts		0
Operating current		
• at AC-1 at 400 V Rated value	A	20
• at AC-51 Rated value	A	20
Operating current of the MCB with AC Rated value	A	20
Operating current minimum	mA	500
Operating voltage with AC		
• at 50 Hz Rated value	V	48 ... 460
• at 60 Hz Rated value	V	48 ... 460
Operating range relative to the operating voltage with AC		
• at 50 Hz	V	40 ... 506
• at 60 Hz	V	40 ... 506
Operating frequency Rated value	Hz	50 ... 60
Insulation voltage Rated value	V	600
Rate of voltage rise at the thyristor for main contacts maximum permissible	V/ μ s	1 000
Blocking voltage at the thyristor for main contacts maximum permissible	V	1 200
Reverse current of the thyristor	mA	10
Derating temperature	$^{\circ}$ C	40
Active power loss total typical	W	20
Surge current resistance Rated value	A	1 150
I²t value maximum	A ² ·s	6 600

Control circuit/ Control:

Control supply voltage frequency		
• 1 Rated value	Hz	50
• 2 Rated value	Hz	60
Type of voltage of the control supply voltage		AC
Control supply voltage 1		
• with AC		
— at 50 Hz Initial rated value	V	110
— at 50 Hz Final rated value	V	230
— at 60 Hz Initial rated value	V	110
— at 60 Hz Final rated value	V	230
Control supply voltage		
• with AC		
— at 50 Hz Full-scale value for signal<0> recognition	V	40

— at 60 Hz Full-scale value for signal<0> recognition	V	40
Symmetrical line frequency tolerance	Hz	5
Control current		
• at minimum control supply voltage		
— with AC	mA	2
• with AC Rated value	mA	15

Installation/ mounting/ dimensions:





Mounting type		screw and snap-on mounting onto 35 mm standard mounting rail
Mounting type Side-by-side mounting		Yes
Design of the thread of the screw for securing the equipment		M4
Tightening torque of the screw for securing the equipment	N·m	1.5
Width	mm	22.5
Height	mm	100
Depth	mm	140.5

Connections/ Terminals:

Type of electrical connection for main current circuit		ring cable connection
Design of the thread of the connection screw for main contacts		M5
Tightening torque for main contacts with screw-type terminals	N·m	2 ... 2.5
Type of connectable conductor cross-section for main contacts		
• for JIS cable lug		JIS C 2805 R 2-5, 5,5-5, 8-5, 14-5
Type of connectable conductor cross-section		
• for DIN cable lug for main contacts		DIN 46234 -5-2,5, -5-6, -5-10, -5-16, -5-25
• for AWG conductors		
— for auxiliary and control contacts		1x (AWG 20 ... 12)
Type of connectable conductor cross-section for auxiliary and control contacts		
• solid		1x (0.5 ... 2.5 mm ²), 2x (0.5 ... 1.0 mm ²)
• finely stranded		
— with core end processing		1x (0.5 ... 2.5 mm ²), 2x (0.5 ... 1.0 mm ²)
— without core end processing		1x (0.5 ... 2.5 mm ²), 2x (0.5 ... 1.0 mm ²)
Connectable conductor cross-section		
• for auxiliary and control contacts		
— solid	mm ²	0.5 ... 2.5
— finely stranded		
— with core end processing	mm ²	0.5 ... 2.5
— without core end processing	mm ²	0.5 ... 2.5

Type of electrical connection for auxiliary and control current circuit		ring cable connection
Design of the thread of the connection screw of the auxiliary and control contacts		M3
AWG number as coded connectable conductor cross section for auxiliary and control contacts		20 ... 12
Wire stripping length of the cable <ul style="list-style-type: none"> • for main contacts • for auxiliary and control contacts 	mm mm	10 10
Tightening torque for auxiliary and control contacts with screw-type terminals	N·m	0.5 ... 0.6
Tightening torque [lbf·in] for auxiliary and control contacts with screw-type terminals	lbf·in	4.5 ... 5.3

Certificates/ approvals:

General Product Approval	EMC	Declaration of Conformity	Test Certificates
 CSA	 UL	 EAC	 C-TICK
		 EG-Konf.	Type Test Certificates/Test Report

other

[Environmental Confirmations](#)

Further information

Short-circuit protection, design of the fuse link

https://www.automation.siemens.com/cd-static/material/info/3RF23_eng.pdf

Information- and Downloadcenter (Catalogs, Brochures,...)

<http://www.siemens.com/industrial-controls/catalogs>

Industry Mall (Online ordering system)

<http://www.siemens.com/industrymall>

Cax online generator

<http://support.automation.siemens.com/WW/CAXorder/default.aspx?lang=en&mlfb=3RF23203DA24>

Service&Support (Manuals, Certificates, Characteristics, FAQs,...)

<http://support.automation.siemens.com/WW/view/en/3RF23203DA24/all>

Image database (product images, 2D dimension drawings, 3D models, device circuit diagrams, EPLAN macros, ...)

http://www.automation.siemens.com/bilddb/cax_de.aspx?mlfb=3RF23203DA24&lang=en

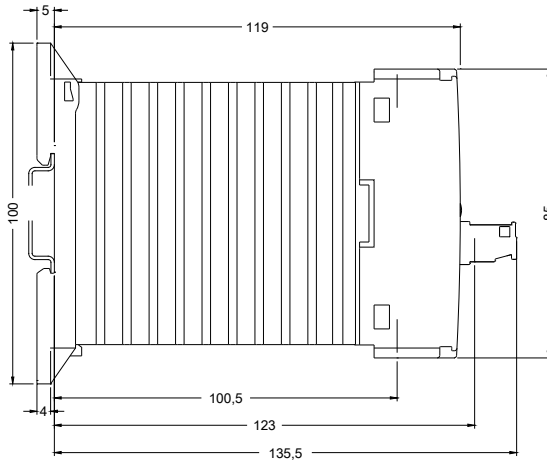
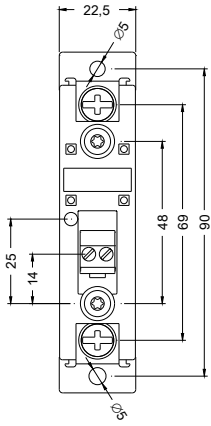

last modified:

09.03.2015