

# Specification

Patent Pending

- Part No. : **FXP.830.07.0100C**
- Product Name : FXP.830 Freedom Dual Band Wi-Fi  
2.4/5.8 GHz Dipole Antenna
- Features : Very High Efficiency  
Dual Band  
Ground-plane Independent  
IPEX MHF1 Connector (U.FL compatible)  
**RoHS Compliant**



## 1. Introduction

The FXP.830 has a peak gain of 1.8dBi at 2.4GHz and efficiencies of 50%, and 3-4dBi and 80-90% at 5.8GHz.

The FXP830 is a high efficiency, small, dual-band, dipole antenna for 2.4/5.8GHz band including Bluetooth and Wi-Fi. This Taoglas patent pending antenna is unique in the market because it is made from poly-flexible material, has a tiny form factor (42\*7\*.01mm) and has double-sided 3M tape for easy "peel and stick" mounting.

The FXP.830 is the ideal all-round antenna solution for squeezing into narrow spaces and still maintaining high performance, for example at the top of LCD devices.

Many module manufacturers specify peak gain limits for any antennas that are to be connected to that module. Those peak gain limits are based on free-space conditions. In practice, the peak gain of an antenna tested in free-space can degrade by at least 1 or 2dBi when put inside a device. So ideally you should go for a slightly higher peak gain antenna than mentioned on the module specification to compensate for this effect, giving you better performance.

Upon testing of any of our antennas with your device and a selection of appropriate layout, integration technique, or cable, Taoglas can make sure any of our antennas' peak gain will be below the peak gain limits. Taoglas can then issue a specification and/or report for the selected antenna in your device that will clearly show it complying with the peak gain limits, so you can be assured you are meeting regulatory requirements for that module.

For example, a module manufacturer may state that the antenna must have less than 2dBi peak gain, but you don't need to select an embedded antenna that has a peak gain of less than 2dBi in free-space. This will give you a less optimized solution. It is better to go for a slightly higher free-space peak gain of 3dBi or more if available. Once that antenna gets integrated into your device, performance will degrade below this 2dBi peak gain due to the effects of GND plane, surrounding components, and

device housing. If you want to be absolutely sure, contact Taoglas and we will test. Choosing a Taoglas antenna with a higher peak gain than what is specified by the module manufacturer and enlisting our help will ensure you are getting the best performance possible without exceeding the peak gain limits.

## 2. Specification

Electrical		
Frequency	2.4GHz	5.8GHz
Peak Gain (free space)	2.55dBi	4.66dBi
Peak Gain (on plastic*)	3.32dBi	6.11dBi
Average Gain (free space)	-3.0dBi	-0.6dBi
Average Gain (on plastic)	-3.0dBi	-0.7dBi
Efficiency (free space)	50%	86%
Efficiency (on plastic)	50%	84%
Polarization	Linear	
Impedance	50 Ohms	
Radiation Pattern	Omnidirectional	
Input Power	2W max.	
Mechanical		
Dimensions	42*7mm	
Antenna Body Material	Polymer	
Cable	Gray 100mm 1.37 co-axial	
Connector	IpeX MHF	
Environmental		
Temperature Range	-40°C to 85°C	
Humidity	Non-condensing 65°C 95% RH	

\* FXP.830 is likely to be mounted on plastic in many applications so we provide the antenna measurement in both free space and mounted on a 1mm thick plastic.

### 3. Antenna Characteristics

#### 3.1 Return Loss

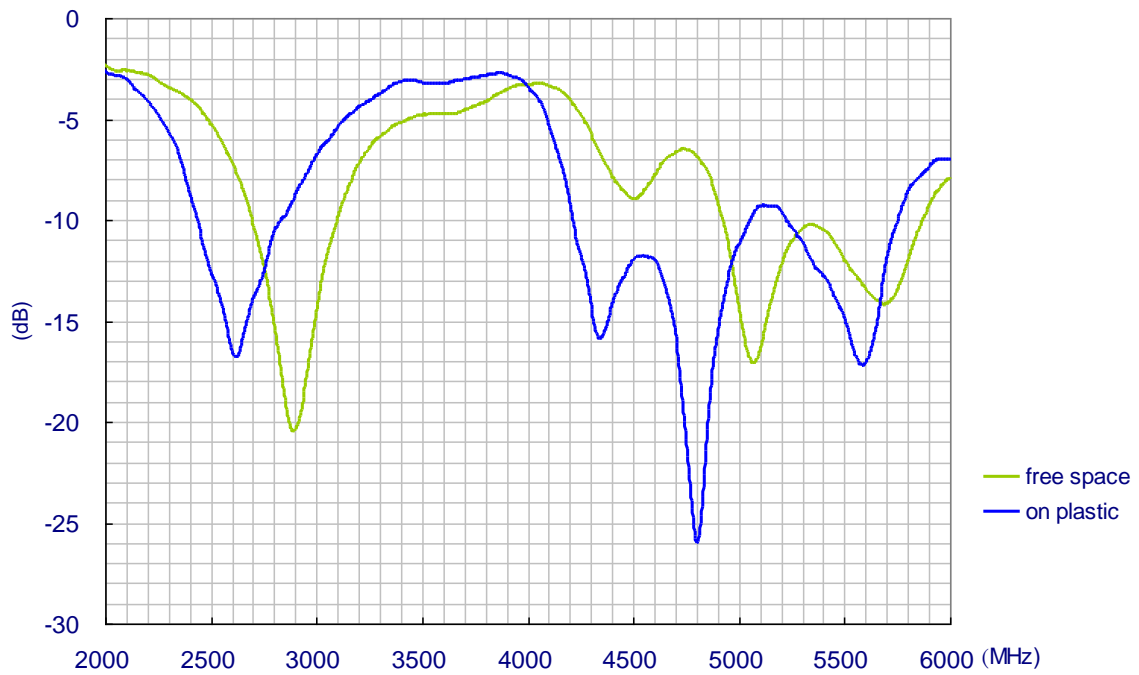

#### 3.2 VSWR

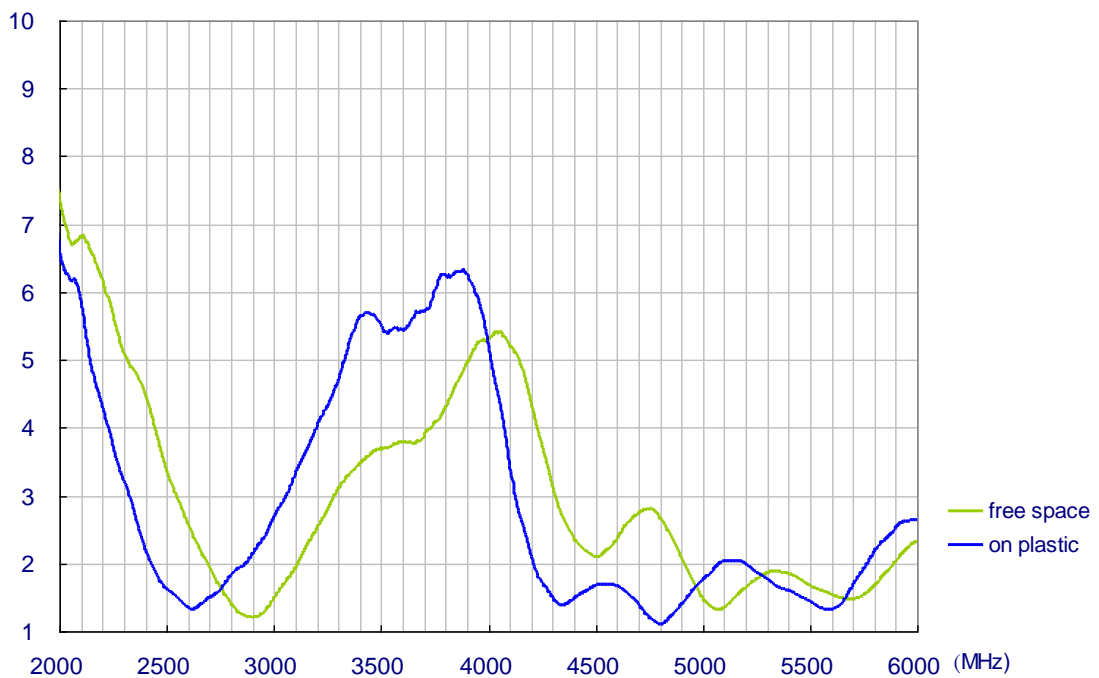

### 3.3 Antenna Efficiency

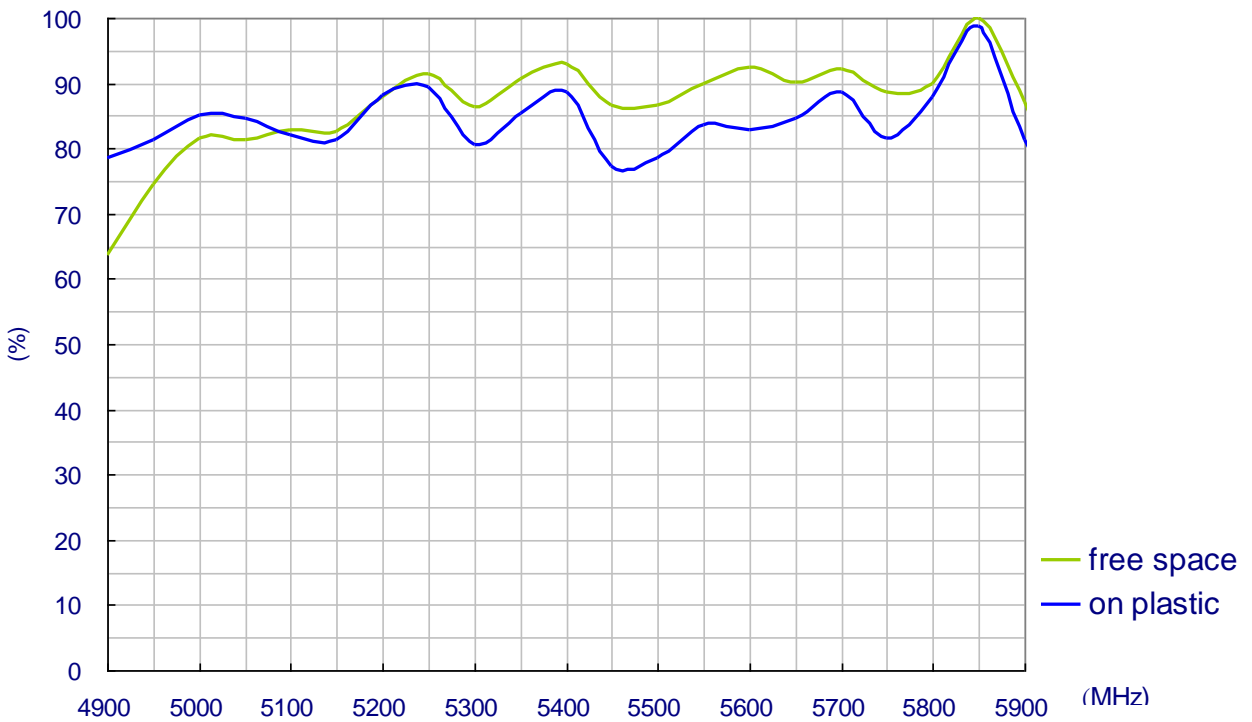
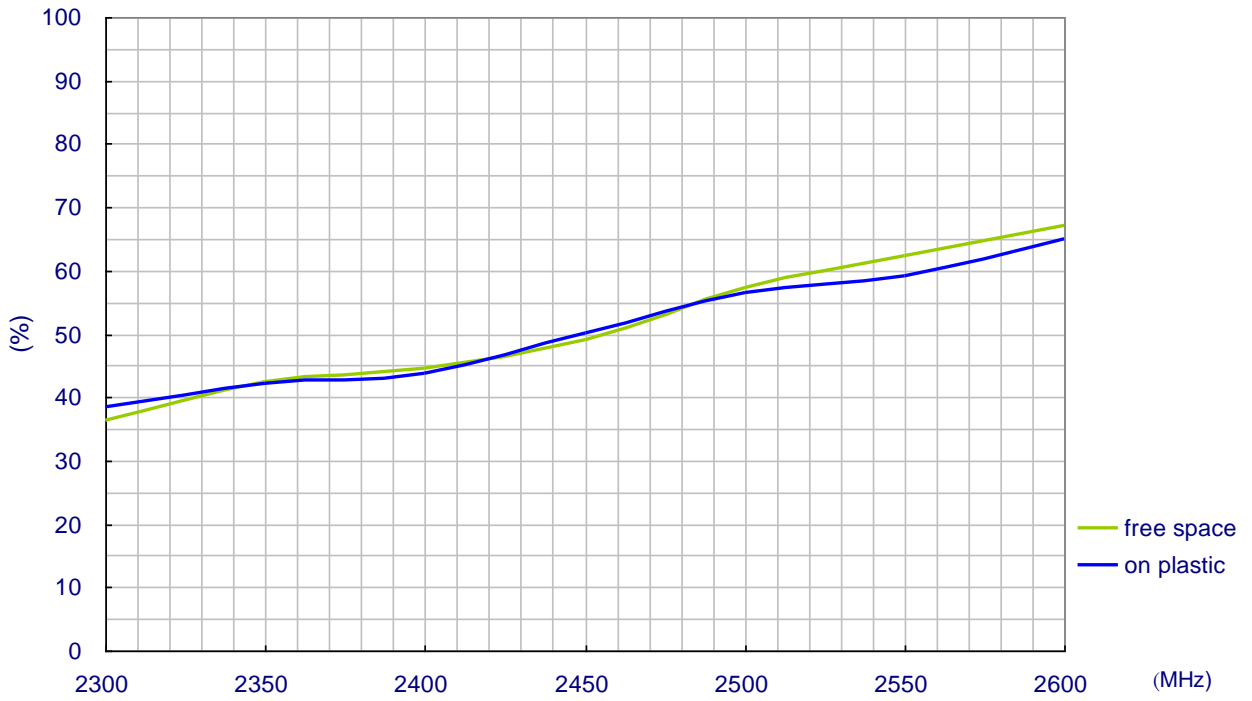

### 3.4 Antenna Peak Gain

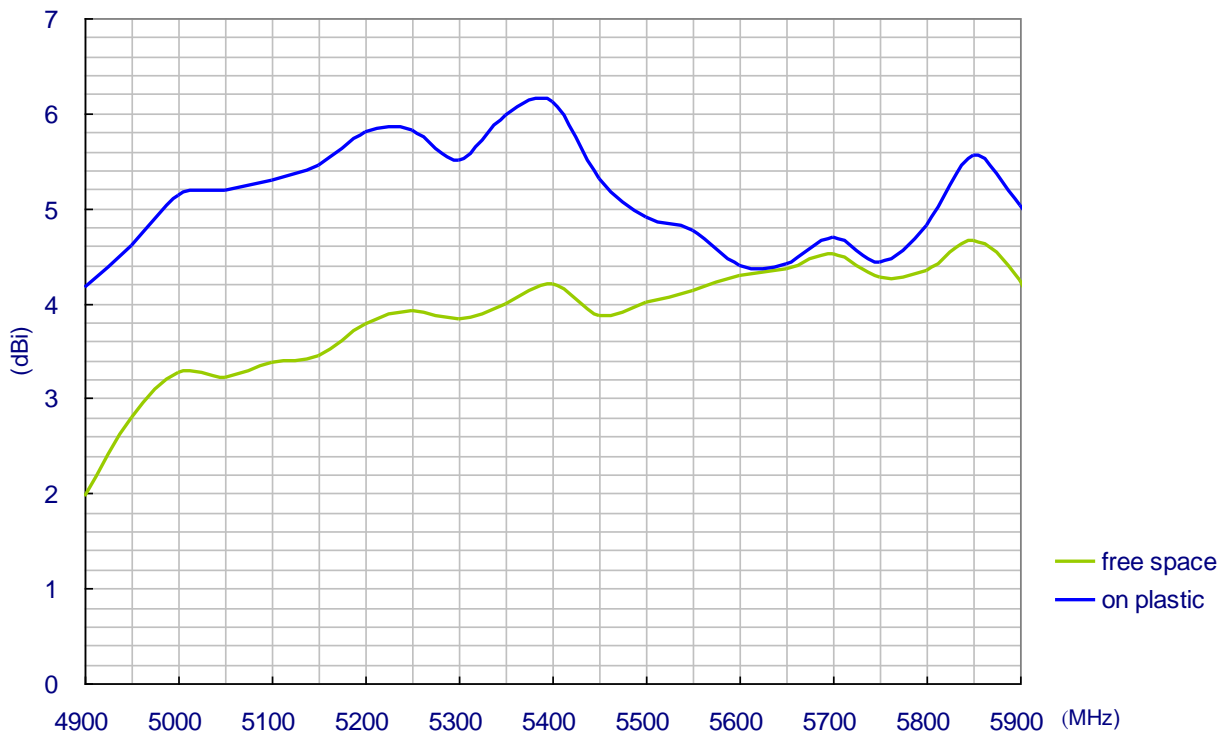
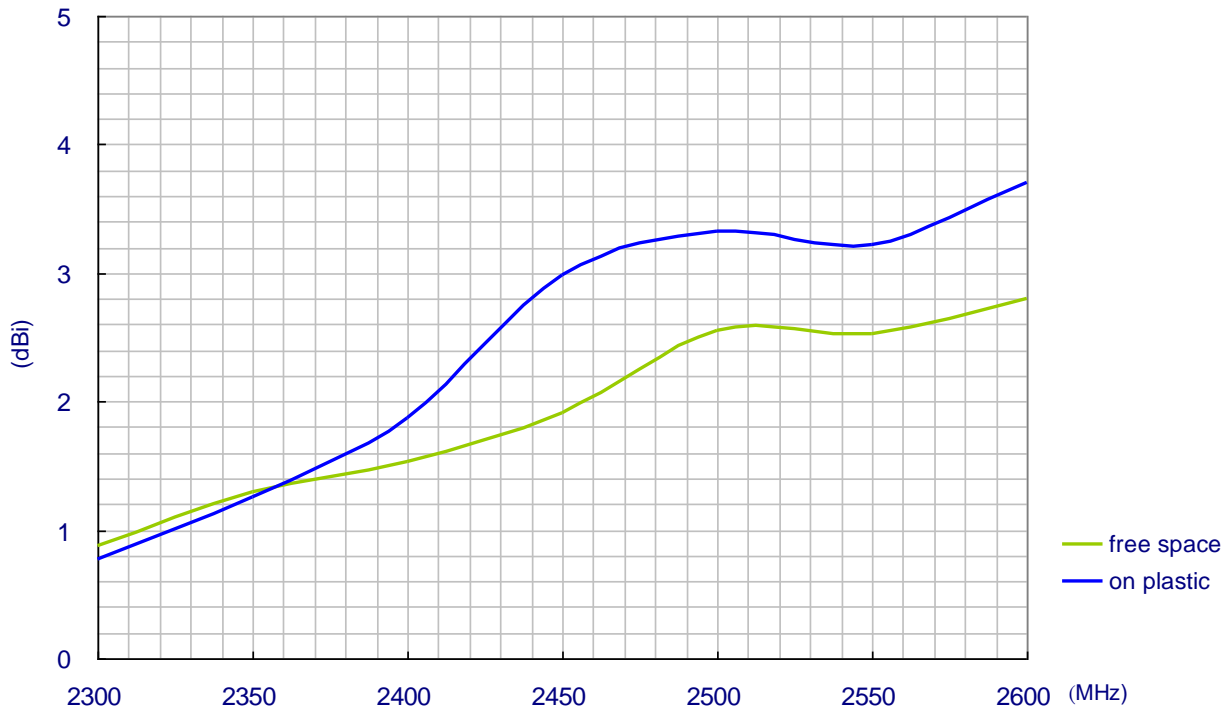

### 3.5 Average Gain

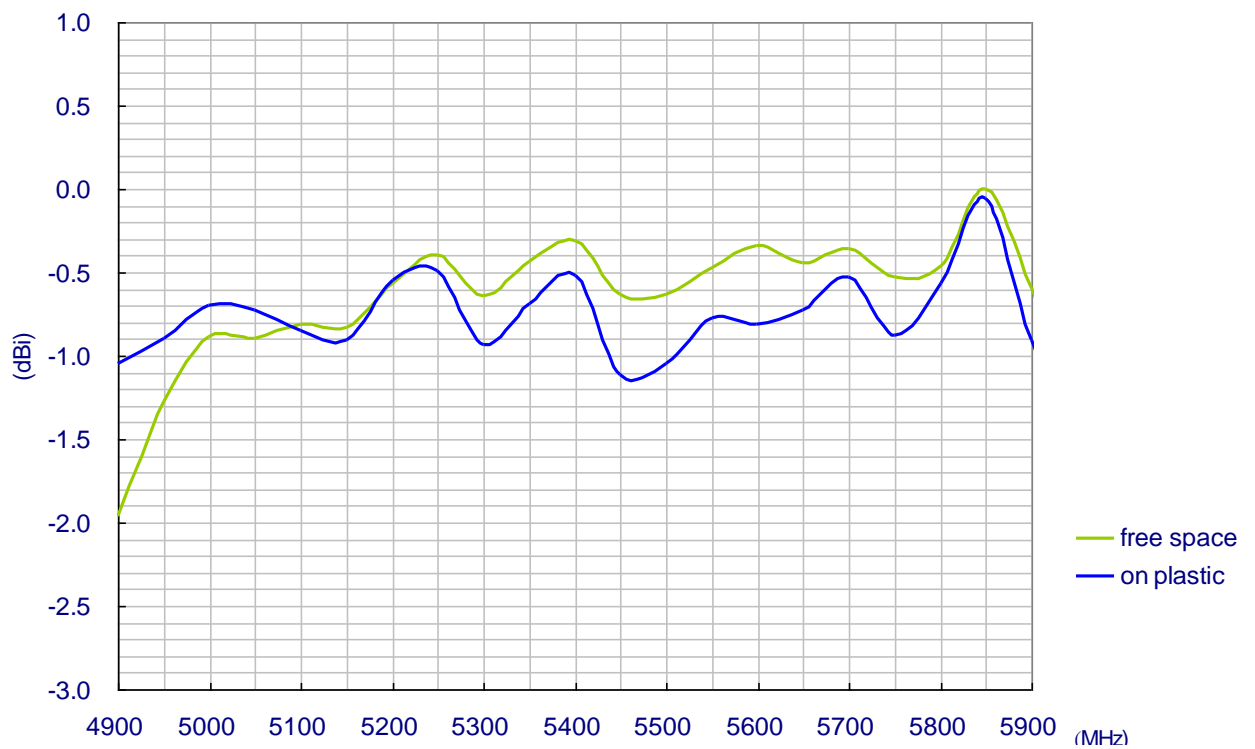
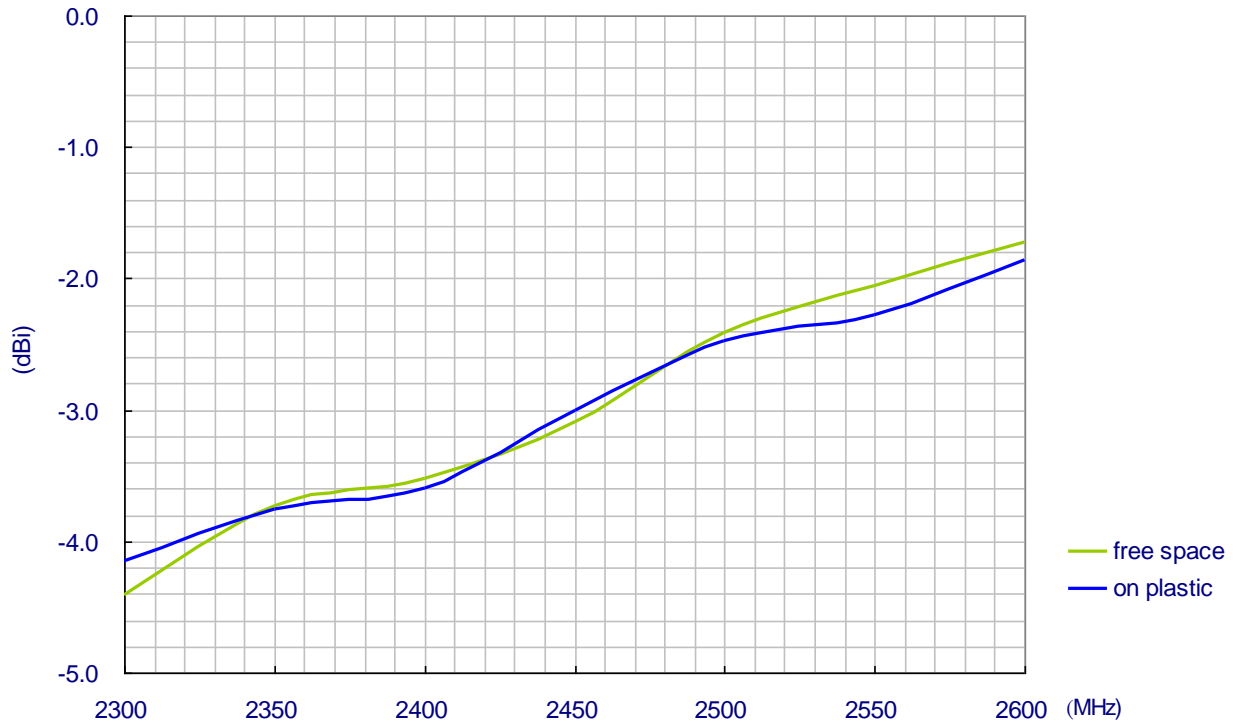



### 3.6 Radiation Pattern for FXP.830 on Plastic

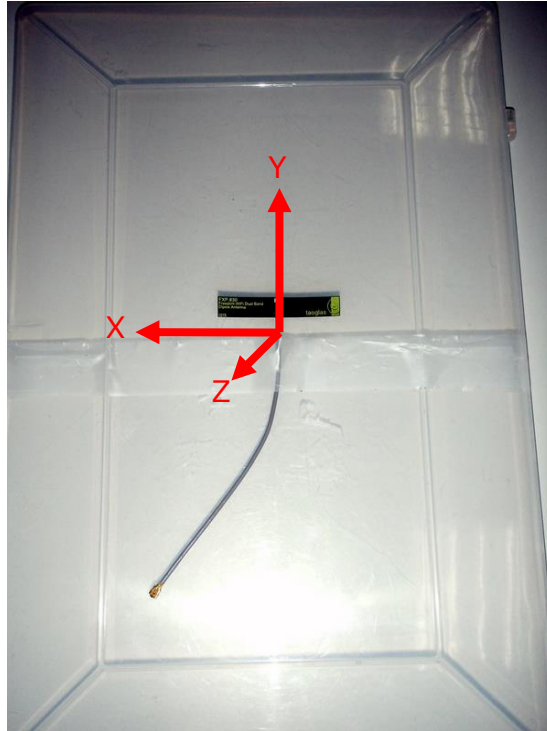

### XY Plane

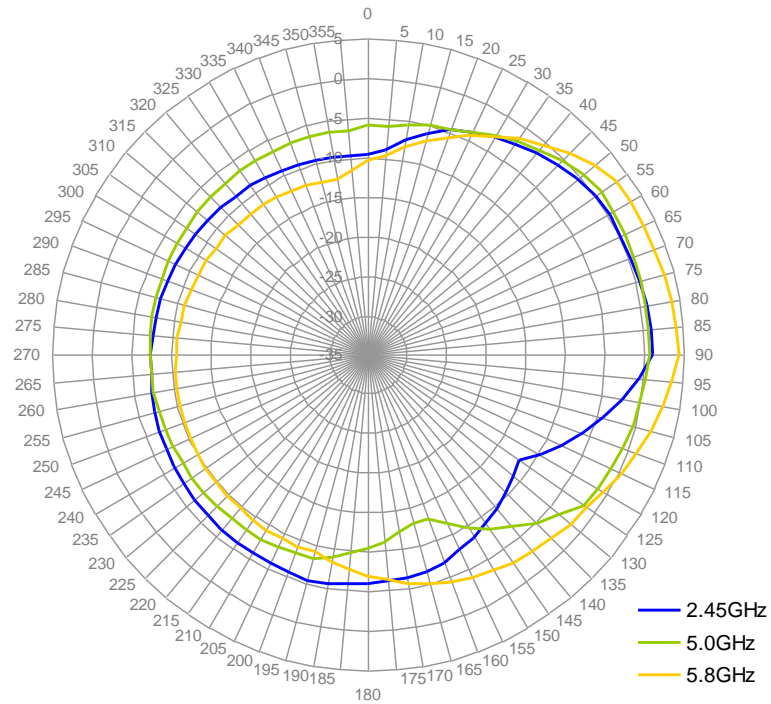

### XZ Plane

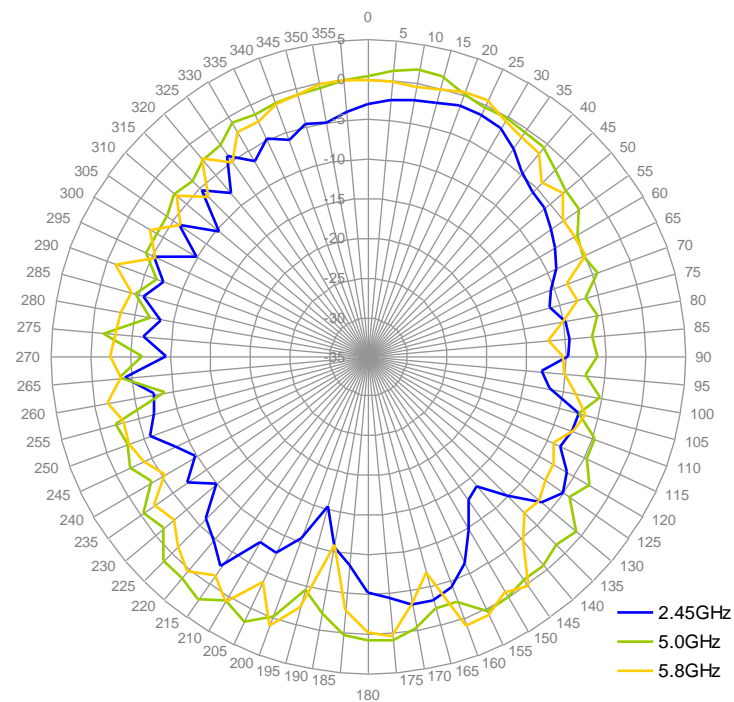

### 3.7 Free Space Radiation

XY Plane

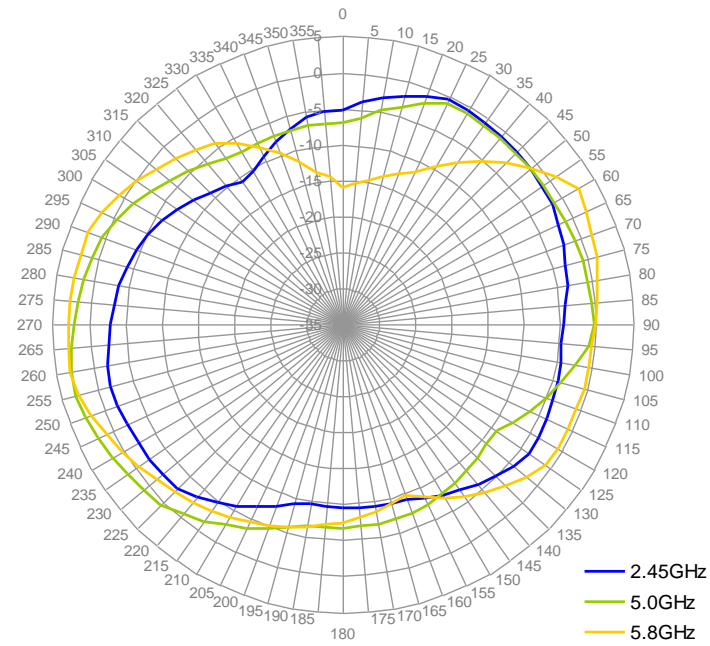

XZ Plane

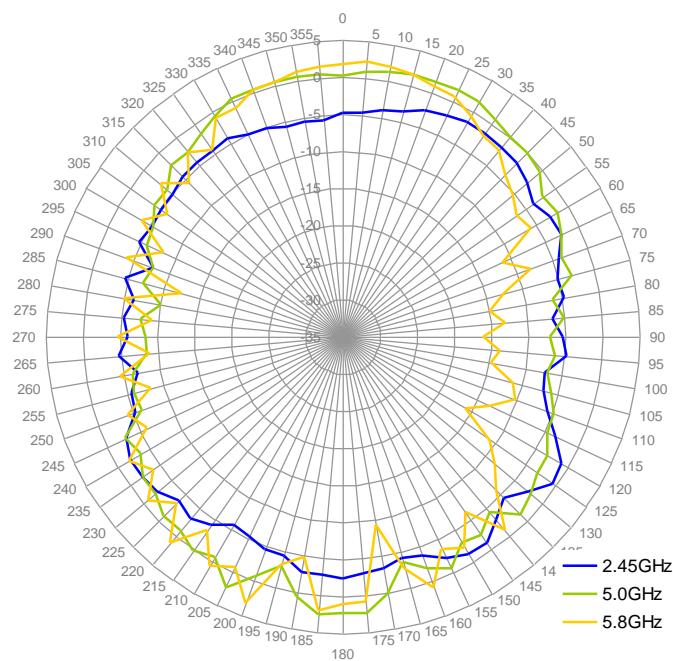



## 5 Packaging

1pcs FXP830.07.0100C per PE Bag  
 Bag Dimensions - 42\*42mm  
 Weight - 7g

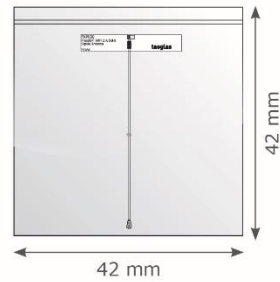

100pcs FXP830.07.0100C per PE Large Bag  
 Bag Dimensions - 140\*130mm  
 Weight - 72g

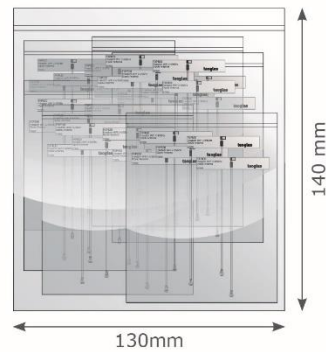

2,000 pcs FXP830.07.0100C per carton  
 Carton - 230\*170\*160mm  
 Weight - 1.6Kg

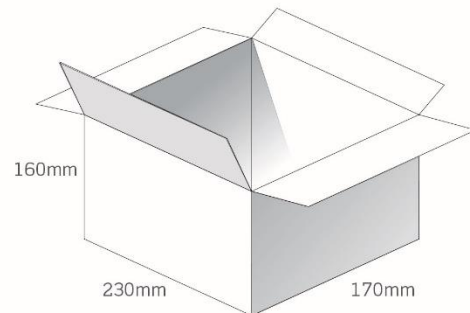

Pallet Dimensions 1200x 1000 x 1480mm  
 200 Cartons per Pallet  
 25 Cartons per layer  
 8 Layers

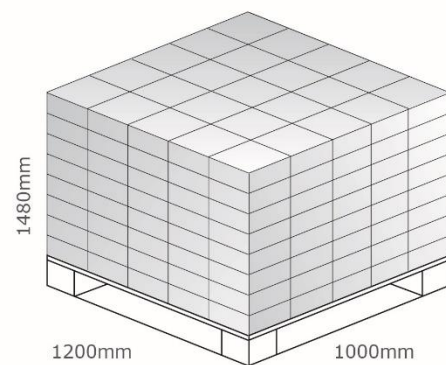

Taoglas makes no warranties based on the accuracy or completeness of the contents of this document and reserves the right to make changes to specifications and product descriptions at any time without notice. Taoglas reserves all rights to this document and the information contained herein.

Reproduction, use or disclosure to third parties without express permission is strictly prohibited.

Copyright © Taoglas Ltd.