



# GL6G-P4211

G6

MINIATURE PHOTOELECTRIC SENSORS

**SICK**  
Sensor Intelligence.



Illustration may differ



### Ordering information

Type	Part no.
GL6G-P4211	1059632

Other models and accessories → [www.sick.com/G6](http://www.sick.com/G6)

### Detailed technical data

#### Features

<b>Device type</b>	Photoelectric sensors
<b>Functional principle</b>	Photoelectric retro-reflective sensor
<b>Functional principle detail</b>	Dual lens
<b>Sensing range max.</b>	≤ 6 m <sup>1)</sup>
<b>Sensing range</b>	≤ 5 m <sup>1)</sup>
<b>Polarisation filters</b>	Yes
<b>Emitted beam</b>	
Light source	PinPoint LED <sup>2)</sup>
Type of light	Visible red light
<b>Light spot size (distance)</b>	Ø 8 mm (350 mm)
<b>Key LED figures</b>	
Wave length	650 nm
<b>Adjustment</b>	Potentiometer, 270 °
<b>Special applications</b>	Detecting transparent objects

<sup>1)</sup> Reflector PL80A.

<sup>2)</sup> Average service life: 100,000 h at T<sub>U</sub> = +25 °C.

#### Safety-related parameters

<b>MTTF<sub>D</sub></b>	1,895 years
<b>DC<sub>avg</sub></b>	0 %

## Electrical data

<b>Supply voltage <math>U_B</math></b>	10 V DC ... 30 V DC <sup>1)</sup>
<b>Ripple</b>	$\pm 10\%$ <sup>2)</sup>
<b>Power consumption</b>	30 mA <sup>3)</sup>
<b>Protection class</b>	III
<b>Digital output</b>	
Type	PNP
Signal voltage PNP HIGH/LOW	$V_S - (\leq 3\text{ V}) / \text{approx. } 0\text{ V}$
Output current $I_{\text{max}}$	$\leq 100\text{ mA}$ <sup>4)</sup>
Response time	$< 625\ \mu\text{s}$ <sup>5)</sup>
Switching frequency	1,000 Hz <sup>6)</sup>
<b>Attenuation along light beam</b>	$> 20\%$
<b>Switching mode</b>	Light/dark switching
<b>Switching mode selector</b>	Selectable via light/dark selector
<b>Circuit protection</b>	A <sup>7)</sup> B <sup>8)</sup> D <sup>9)</sup>

<sup>1)</sup> Limit values when operated in short-circuit protected network: max. 8 A.

<sup>2)</sup> May not exceed or fall below  $U_V$  tolerances.

<sup>3)</sup> Without load.

<sup>4)</sup> At  $U_V > 24\text{ V}$ ,  $I_A \text{ max.} = 50\text{ mA}$ .

<sup>5)</sup> Signal transit time with resistive load.

<sup>6)</sup> With light/dark ratio 1:1.

<sup>7)</sup> A =  $V_S$  connections reverse-polarity protected.

<sup>8)</sup> B = inputs and output reverse-polarity protected.

<sup>9)</sup> D = outputs overcurrent and short-circuit protected.

## Mechanical data

<b>Housing</b>	Rectangular
<b>Dimensions (W x H x D)</b>	12 mm x 31.5 mm x 21 mm
<b>Connection</b>	Male connector M8, 4-pin
<b>Material</b>	
Housing	Plastic, ABS/PC
Front screen	Plastic, PMMA
<b>Weight</b>	20 g

## Ambient data

<b>Enclosure rating</b>	IP67
<b>Ambient operating temperature</b>	$-25\text{ }^\circ\text{C} \dots +55\text{ }^\circ\text{C}$ <sup>1)</sup>
<b>Ambient temperature, storage</b>	$-40\text{ }^\circ\text{C} \dots +70\text{ }^\circ\text{C}$
<b>UL File No.</b>	NRKH.E348498 & NRKH7.E348498

<sup>1)</sup> Temperature stability following adjustment  $\pm 10\text{ }^\circ\text{C}$ .

## Classifications

<b>ECl@ss 5.0</b>	27270902
-------------------	----------

<b>ECl@ss 5.1.4</b>	27270902
<b>ECl@ss 6.0</b>	27270902
<b>ECl@ss 6.2</b>	27270902
<b>ECl@ss 7.0</b>	27270902
<b>ECl@ss 8.0</b>	27270902
<b>ECl@ss 8.1</b>	27270902
<b>ECl@ss 9.0</b>	27270902
<b>ECl@ss 10.0</b>	27270902
<b>ECl@ss 11.0</b>	27270902
<b>ETIM 5.0</b>	EC002717
<b>ETIM 6.0</b>	EC002717
<b>ETIM 7.0</b>	EC002717
<b>ETIM 8.0</b>	EC002717
<b>UNSPSC 16.0901</b>	39121528

### Connection type

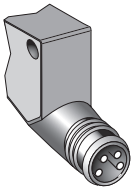

### Connection diagram

Cd-066

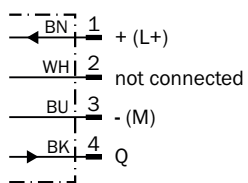

### Characteristic curve

GL6

Operating reserve

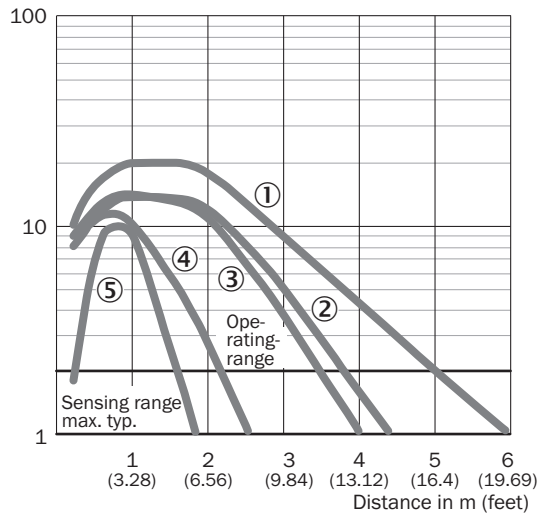

- ① Reflector PL80A
- ② Reflector PL40A
- ③ Reflector P250
- ④ Reflector PL20A
- ⑤ Reflective tape REF-IRF-56

### Light spot size

GL6, GL6G

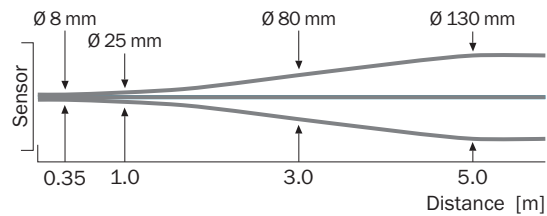

### Sensing range diagram

GL6, GL6G

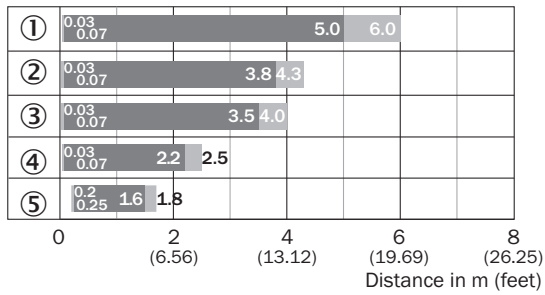

■ Sensing range                      ■ Sensing range max.

- ① Reflector PL80A
- ② Reflector PL40A
- ③ Reflector P250
- ④ Reflector PL20A
- ⑤ Reflective tape REF-IRF-56

### Adjustments

Adjustment possibility

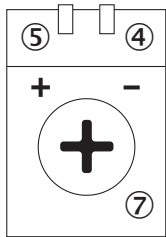

- ④ LED indicator green: Supply voltage active
- ⑤ LED indicator yellow: Status of received light beam
- ⑦ Sensitivity control: potentiometer



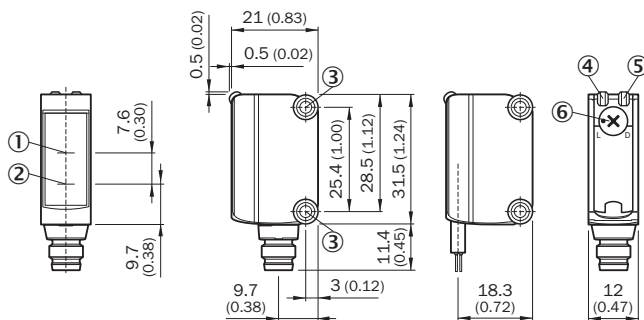

### Dimensional drawing (Dimensions in mm (inch))



- ① Optical axis, receiver
- ② Optical axis, sender
- ③ Mounting holes M3
- ④ LED indicator green: Supply voltage active
- ⑤ LED indicator yellow: Status of received light beam
- ⑥ Light/ dark rotary switch: L = light switching, D = dark switching

## Recommended accessories

Other models and accessories → [www.sick.com/G6](http://www.sick.com/G6)

	Brief description	Type	Part no.
<b>Mounting brackets and plates</b>			
	Stainless steel (1.4301)	BEF-WN-G6	2062909
	Universal mounting bracket for reflectors, steel, zinc coated	BEF-WN-REFX	2064574
<b>Plug connectors and cables</b>			
	Head A: female connector, M8, 4-pin, straight, A-coded Head B: Flying leads Cable: Sensor/actuator cable, PVC, unshielded, 5 m	YF8U14-050VA3XLEAX	2095889
	Head A: male connector, M8, 4-pin, straight Head B: - Cable: unshielded	STE-0804-G	6037323
<b>Reflectors</b>			
	Rectangular, screw connection, 51 mm x 61 mm, PMMA/ABS, Screw-on, 2 hole mounting	P250	5304812

## SICK AT A GLANCE

SICK is one of the leading manufacturers of intelligent sensors and sensor solutions for industrial applications. A unique range of products and services creates the perfect basis for controlling processes securely and efficiently, protecting individuals from accidents and preventing damage to the environment.

We have extensive experience in a wide range of industries and understand their processes and requirements. With intelligent sensors, we can deliver exactly what our customers need. In application centers in Europe, Asia and North America, system solutions are tested and optimized in accordance with customer specifications. All this makes us a reliable supplier and development partner.

Comprehensive services complete our offering: SICK LifeTime Services provide support throughout the machine life cycle and ensure safety and productivity.

For us, that is “Sensor Intelligence.”

## WORLDWIDE PRESENCE:

Contacts and other locations –[www.sick.com](http://www.sick.com)