

170361-1 ✓ ACTIVE

MATE-N-LOK | Mini-Universal MATE-N-LOK

TE Internal #: 170361-1

Mini-Universal MATE-N-LOK, Power Contacts, Contact, Operating Voltage 600 VAC, Operating Voltage 600 VDC, Pre-Tin, 26 – 22AWG Wire Size

[View on TE.com >](#)



Connectors > Power Connectors > Power Contacts

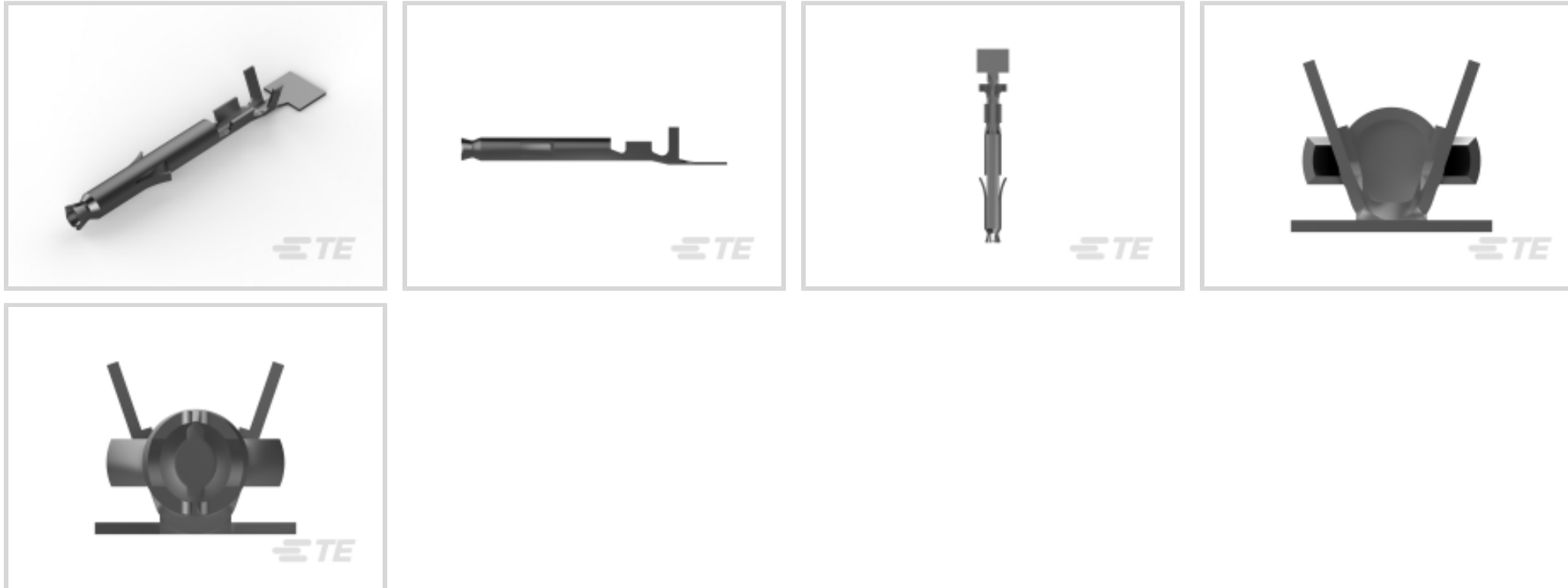

Power Contact Type: **Contact**

Operating Voltage: **600 VDC**

Contact Mating Area Plating Material: **Pre-Tin**

Wire Size: **26 – 22 AWG**

## Features

### Product Type Features

Power Contact Type	Contact
Connector System	Wire-to-Wire
Connector & Contact Terminates To	Wire & Cable

### Electrical Characteristics

Operating Voltage	600 VDC
-------------------	---------

### Contact Features

Contact Mating Area Plating Material	Pre-Tin
Contact Current Rating (Max)	7 A
Contact Type	Socket
Contact Retention Within Housing	With
Mating Pin Diameter	1 mm [.039 in]
Contact Base Material	Brass
Contact Mating Area Plating Material Thickness	.8 $\mu$ m [31.49 $\mu$ in]
Wire Contact Termination Area Plating Material Thickness	.8 $\mu$ m [31.49 $\mu$ in]
Wire Contact Termination Area Plating Material	Pre-Tin



Wire Contact Termination Area Plating Material Finish	Matte
---	-------

Contact Orientation	Straight
---------------------	----------

### Termination Features

Termination Method to Wire & Cable	Crimp
------------------------------------	-------

### Mechanical Attachment

Connector Mounting Type	Cable Mount (Free-Hanging)
-------------------------	----------------------------

Wire Insulation Support	Without
-------------------------	---------

### Dimensions

Wire Size	.12 – .35 mm <sup>2</sup>
-----------	---------------------------

Accepts Wire Insulation Diameter Range	1.19 – 1.75 mm [.047 – .069 in]
--	---------------------------------

### Usage Conditions

Operating Temperature Range	-20 – 105 °C [-4 – 221 °F]
-----------------------------	----------------------------

### Operation/Application

Circuit Application	Power
---------------------	-------

### Industry Standards

CSA Rating	Certified
------------	-----------

Glow Wire Rating	Standard Part - Not Glow Wire
------------------	-------------------------------

VDE Tested	No
------------	----

Agency/Standard	CSA, UL
-----------------	---------

CSA File Number	LR 7189
-----------------	---------

UL Rating	Recognized
-----------	------------

UL File Number	E28476
----------------	--------

### Packaging Features

Packaging Method	Reel
------------------	------

Packaging Quantity	6000
--------------------	------

### Other

Wire/Cable Type	Discrete Wire
-----------------	---------------

Wire Type	Stranded
-----------	----------

For Use With	Plug Housing
--------------	--------------

### Product Compliance

For compliance documentation, visit the product page on [TE.com](https://www.te.com)>



EU RoHS Directive 2011/65/EU	Compliant
EU ELV Directive 2000/53/EC	Compliant
China RoHS 2 Directive MIIT Order No 32, 2016	No Restricted Materials Above Threshold
EU REACH Regulation (EC) No. 1907/2006	Current ECHA Candidate List: JAN 2021 (211) Candidate List Declared Against: JAN 2021 (211) Does not contain REACH SVHC
Halogen Content	Low Halogen - Br, Cl, F, I < 900 ppm per homogenous material. Also BFR/CFR/PVC Free
Solder Process Capability	Not applicable for solder process capability

Product Compliance Disclaimer

This information is provided based on reasonable inquiry of our suppliers and represents our current actual knowledge based on the information they provided. This information is subject to change. The part numbers that TE has identified as EU RoHS compliant have a maximum concentration of 0.1% by weight in homogenous materials for lead, hexavalent chromium, mercury, PBB, PBDE, DBP, BBP, DEHP, DIBP, and 0.01% for cadmium, or qualify for an exemption to these limits as defined in the Annexes of Directive 2011/65/EU (RoHS2). Finished electrical and electronic equipment products will be CE marked as required by Directive 2011/65/EU. Components may not be CE marked. Additionally, the part numbers that TE has identified as EU ELV compliant have a maximum concentration of 0.1% by weight in homogenous materials for lead, hexavalent chromium, and mercury, and 0.01% for cadmium, or qualify for an exemption to these limits as defined in the Annexes of Directive 2000/53/EC (ELV). Regarding the REACH Regulation, the information TE provides on SVHC in articles for this part number is based on the latest European Chemicals Agency (ECHA) 'Guidance on requirements for substances in articles' posted at this URL: <https://echa.europa.eu/guidance-documents/guidance-on-reach>

## Compatible Parts

 <p>TE Part # 91529-1 CCII MINI-UMNL PIN 26-22 ASSY</p>	 <p>TE Part # 90758-2 PROCrimp DIE MINI UNIV MNL</p>	 <p>TE Part # 189727-1 EXTRACTION TOOL</p>	 <p>TE Part # 770586-1 22P MINI UMNL PLUG HSG</p>
 <p>TE Part # 770582-1 14P MINI UMNL PLUG HSG</p>	 <p>TE Part # 770585-1 20P MINI UMNL PLUG HSG</p>	 <p>TE Part # 172333-1 MINI UNIVERSAL M-N-L HOUSING</p>	 <p>TE Part # 770580-1 10P MINI UMNL PLUG HSG</p>



## Also in the Series | Mini-Universal MATE-N-LOK

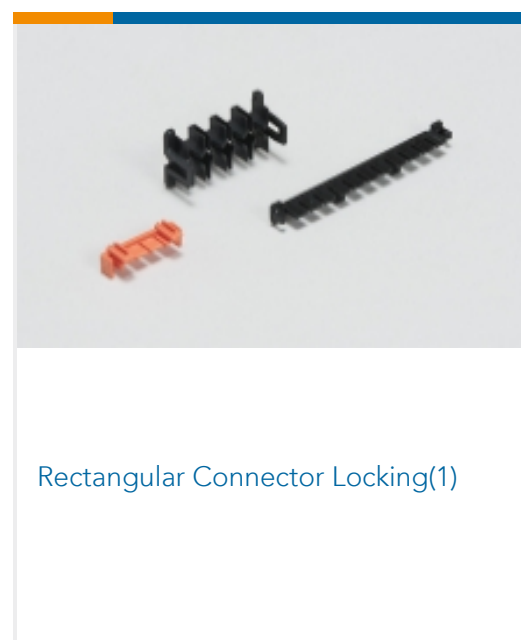
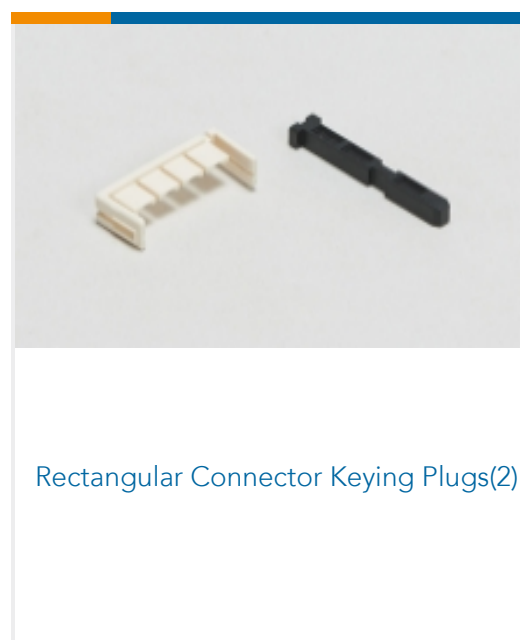
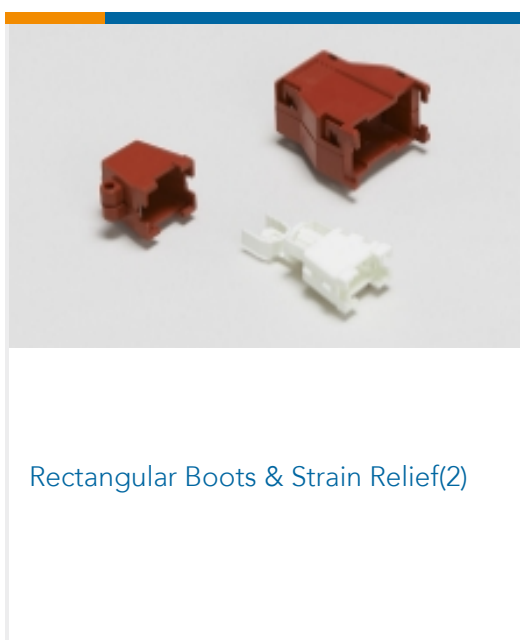
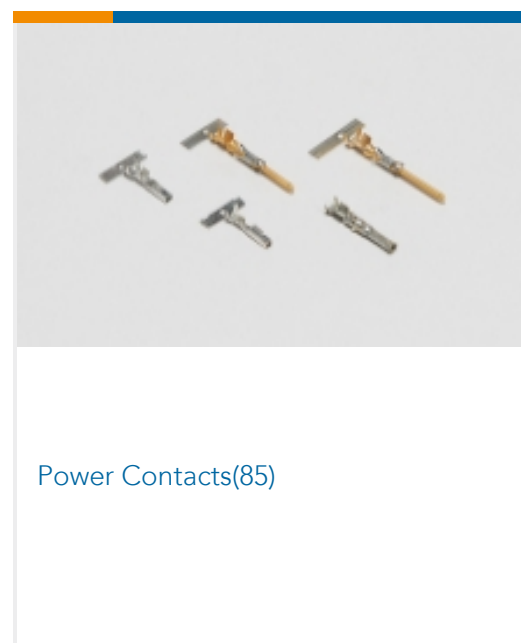
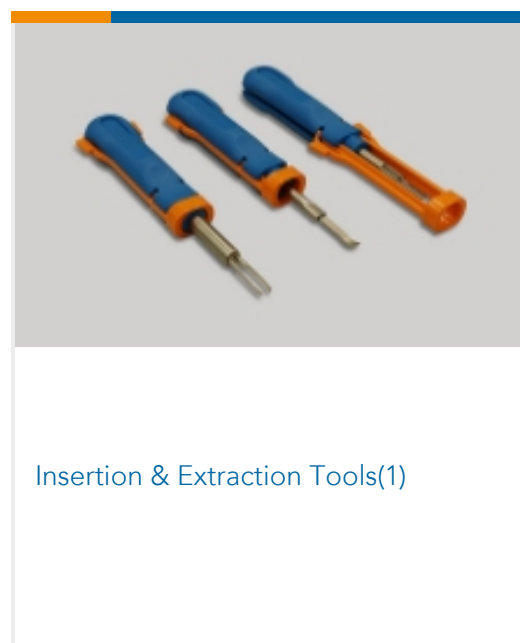
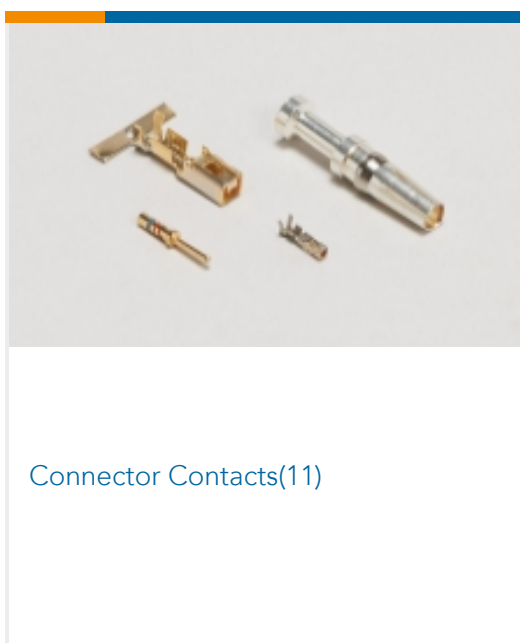

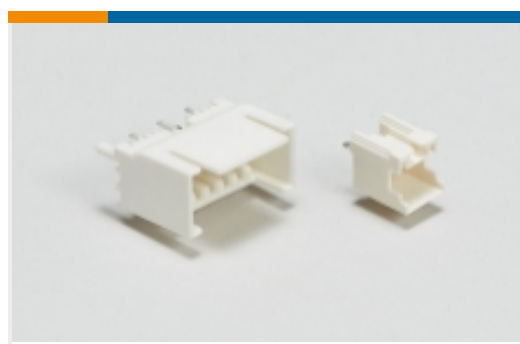

Rectangular Power Connectors(285)

Wire-to-Board Headers & Receptacles  
(1)

## Customers Also Bought

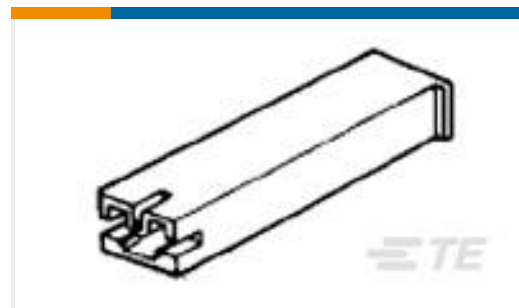
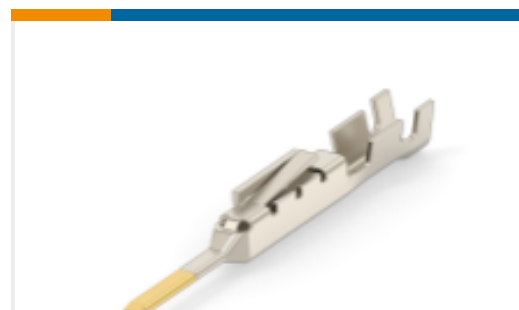
TE Part #171822-3  
EIS REC. HSG 3P-NATURALTE Part #171822-2  
EIS REC. HSG 2P-NATURALTE Part #170262-2  
EIS CONTACTTE Part #172074-1  
187 HSG. PLMKII REC. NATTE Part #170362-1  
UNIV M-N-L SOC. 22-18 AWGTE Part #170359-1  
UNIV M-N-L PIN 26-22 AWGTE Part #170360-1  
UNIV M-N-L PIN 22-18 AWGTE Part #1318105-1  
DYNAMIC 2000 CONTACTTE Part #171637-1  
MINI U-M-N-L SOCKET CONTACTTE Part #HGC208N00000200000  
723 HTEC RECEPTACLE, ANGLED,  
SPEEDTEC

## Documents

### CAD Files

3D PDF

3D

### Customer View Model

[ENG\\_CVM\\_CVM\\_170361-1\\_T.2d\\_dxf.zip](#)

English

### Customer View Model

[ENG\\_CVM\\_CVM\\_170361-1\\_T.3d\\_igs.zip](#)



English

**Customer View Model**

[ENG\\_CVM\\_CVM\\_170361-1\\_T.3d\\_stp.zip](#)

English

By downloading the CAD file I accept and agree to the [Terms and Conditions](#) of use.

---

**Product Specifications**

[Crimping of Mini-Universal MATE-N-LOK Contact](#)

Japanese

[Application Specification](#)

Japanese

---

**Product Environmental Compliance**

[MD\\_170361-1\\_06052015311\\_dmtec](#)

English

[MD\\_170361-1\\_06052015311\\_dmtec](#)

English

---

**Instruction Sheets**

[Instruction Sheet \(non U.S.\)](#)

Japanese

[Mini-Universal MATE-N-LOK Connector](#)

Japanese