

Features:

- High luminous LEDs
- 5mm Round standard directivity
- Long lifetime operation
- Superior weather-resistance
- Water clear type

Applications

- Backlighting (switches, keys, displays, illuminated advertising etc.)
- Substitution of micro incandescent lamps
- Reading lamps/emergency lighting
- Marker lights (e.g. steps, exit ways, etc.)
- Other lighting

Absolute maximum rating (Ta=25°C)

Item	Symbol	Value	Unit
DC Forward current	I_F	30	mA
Pulse forward current*	I_{FP}	100	mA
Reverse voltage	V_R	5	V
Power dissipation	P_D	108	mW
Operating temperature	T_{opr}	-30 to +85	°C
Storage temperature	T_{stg}	-40 to +100	°C
Lead soldering temperature	T_{sol}	260°C/5sec	-

* Pulse width max. 10ms Duty ratio max. 1/10

Electrical – Optical characteristics (Ta=25°C)

Item	Symbol	Condition	Min.	Typ.	Max.	Unit
DC Forward voltage	V_F	$I_F = 20\text{mA}$	2.8	3.1	3.6	V
DC Reverse current	I_R	$V_R = 5\text{V}$	-	-	10	μA
Luminous flux*	Φ_V	$I_F = 20\text{mA}$	8.0	8.5	-	lm
Chromaticity coordinates [†]	x	$I_F = 20\text{mA}$	-	0.395	-	
	y	$I_F = 20\text{mA}$	-	0.455	-	
50% Power angle	$2\theta_{1/2}$	$I_F = 20\text{mA}$	-	15	-	deg

* Luminous flux measurement allowance is $\pm 15\%$

[†] Chromaticity coordinates measurement allowance is $\pm 10\%$

Outline dimensions:

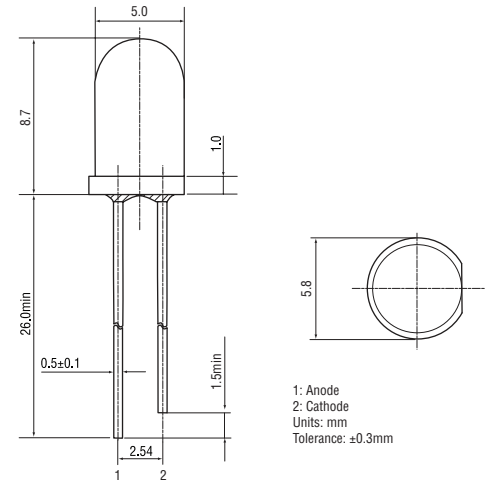

Directivity:

