

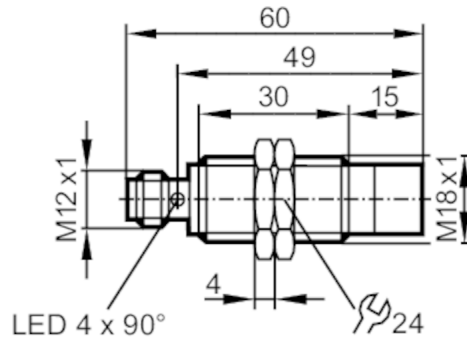

Inductive sensor

IGK3015-APKG/K1/V4A/US-104



Product characteristics

Electrical design	PNP
Output function	normally closed
Sensing range [mm]	15
Housing	threaded type
Dimensions [mm]	M18 x 1 / L = 60

Application

Special feature	Gold-plated contacts; Increased sensing range; Correction factor K = 1; Magnetic-field immune
Application	Industrial applications / factory automation
Magnetic-field immune	yes
Max. magnetic field immunity [mT]	300

Electrical data

Operating voltage [V]	10...30 DC
Current consumption [mA]	< 20
Protection class	III
Reverse polarity protection	yes

Outputs

Electrical design	PNP
Output function	normally closed
Max. voltage drop switching output DC [V]	2.5
Permanent current rating of switching output DC [mA]	100
Switching frequency DC [Hz]	2000
Short-circuit protection	yes
Overload protection	yes

Detection zone

Sensing range [mm]	15
Real sensing range Sr [mm]	15 ± 10 %
Operating distance [mm]	0...12.15
Increased sensing range	yes

IGS307



Inductive sensor

IGK3015-APKG/K1/V4A/US-104

Accuracy / deviations		
Correction factor	steel: 1 / stainless steel: 1 / brass: 1 / aluminium: 1 / copper: 1	
Hysteresis [% of Sr]	3...15	
Switch point drift [% of Sr]	-10...10	
Correction factor K = 1	yes	
Operating conditions		
Ambient temperature [°C]	-40...85	
Protection	IP 65; IP 66; IP 67; IP 68; IP 69K	
Tests / approvals		
EMC	EN 61000-4-2 ESD	4 kV CD / 8 kV AD
	EN 61000-4-3 HF radiated	10 V/m
	EN 61000-4-4 Burst	2 kV
	EN 61000-4-6 HF conducted	10 V
	EN 55011	class B
Vibration resistance	EN 60068-2-6 Fc	20 g 11 ms half-sine; 3 shocks each in every direction of the 3 coordinate axes
Shock resistance	EN 60068-2-27 Ea	100 g 11 ms half-sine; 3 shocks each in every direction of the 3 coordinate axes
Continuous shock resistance	EN 60068-2-27	40 g 6 ms; 4000 shocks each in every direction of the 3 coordinate axes
Fast temperature change	EN 60068-2-14 Na	TA = -40 °C; TB = 85 °C; t1 = 30 min; t2 = < 10 s; 50 cycles
Salt spray test	EN 60068-2-52 Kb	severity level 5 (4 test cycles)
MTTF [years]	469	
UL approval	UL Approval no.	A005
Mechanical data		
Weight [g]	40.2	
Housing	threaded type	
Mounting	non-flush mountable	
Dimensions [mm]	M18 x 1 / L = 60	
Thread designation	M18 x 1	
Materials	stainless steel (1.4404 / 316L); sensing face: LCP white; LED window: PEI; lock nuts: stainless steel (1.4404 / 316L)	
Displays / operating elements		
Display	switching status	4 x LED, yellow
Accessories		
Accessories (supplied)	lock nuts: 2	
Remarks		
Pack quantity	1 pcs.	
Electrical connection - plug		
Connector: 1 x M12; Contacts: gold-plated		

IGS307



Inductive sensor

IGK3015-APKG/K1/V4A/US-104



Connection

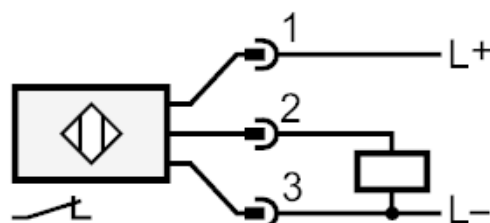

Diagrams and graphs

Installation

