

# APPROVAL SHEET

**WF25P, WF20P, WF10P, WF12P, WF08P,  
WF06P, WF04P**

**$\pm 5\%$ ,  $\pm 1\%$ ,  $\pm 0.5\%$ ,  $\pm 0.1\%$   $1\Omega \sim 10M\Omega$**

**Thick Film High Power Chip Resistors**

**Size 2512 2W, 2010 1W, 1210 1/2W,  
1206 1/2W, 0805 1/4W, 0603 1/8W, 0402 1/8W**

\*Contents in this sheet are subject to change without prior notice.

## FEATURE

1. High power rating and compact size
2. High reliability and stability
3. Reduced size of final equipment
4. RoHS compliant and Lead free products
5. Flame Retardant

## APPLICATION

- Power supply
- PDA
- Digital meter
- Computer
- Automotives
- Battery charger
- DC-DC power converter

## DESCRIPTION

The resistors are constructed in a high grade ceramic body (aluminum oxide). Internal metal electrodes are added at each end and connected by a resistive paste that is applied to the top surface of the substrate. The composition of the paste is adjusted to give the approximate resistance required and the value is trimmed to nominated value within tolerance which controlled by laser trimming of this resistive layer.

The resistive layer is covered with a protective coat. Finally, the two external end terminations are added. For ease of soldering the outer layer of these end terminations is a Tin (lead free) alloy.

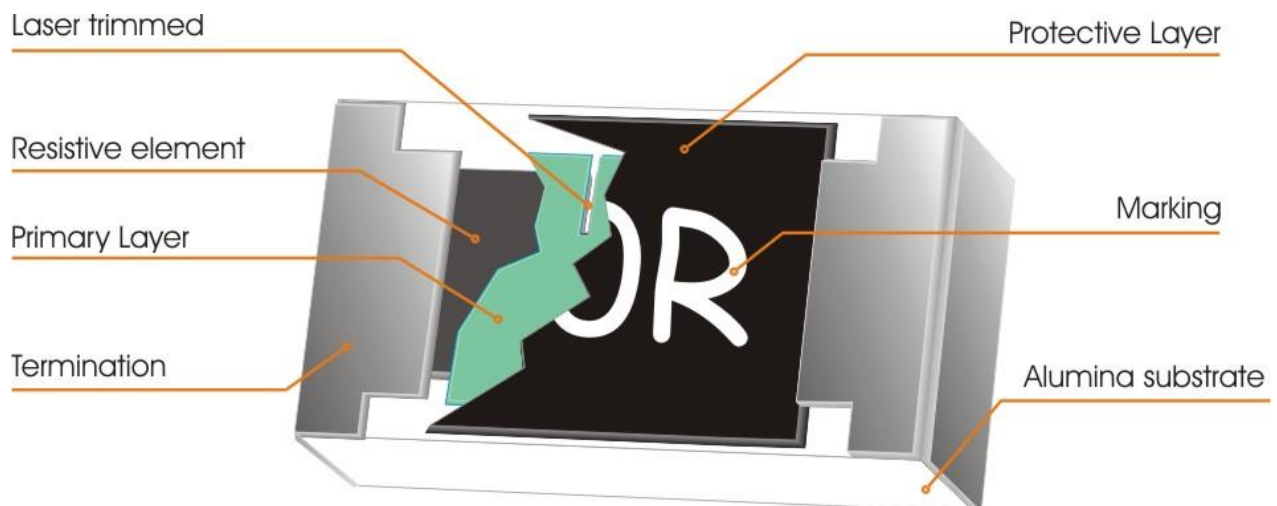

Fig 1. Construction of Chip-R

**QUICK REFERENCE DATA**

Item	General Specification						
Series No.	WF25P	WF20P	WF10P	WF10P	WF08P	WF06P	WF04P
Size code	2512 (6432)	2010 (5025)	1210 (3225)	1206 (3216)	0805 (2012)	0603 (1608)	0402 (1005)
Resistance Tolerance	±1%, ±0.5%, ±0.1% (E24+E96), ±5% (E24)						
Resistance Range	0Ω, 1Ω ~ 1MΩ			0Ω, 1Ω ~ 10MΩ		0Ω, 1Ω ~ 1MΩ	
TCR (ppm/°C)							
10 ~ 10M	±100	±100	±100	±100	±100	±100	±100
< 10	±100	±100	±100	±200	±150	±150	-200/+400
Max. dissipation at T <sub>amb</sub> =70°C	2 W	1 W	1/2 W	1/2W	1/4 W	1/8 W	1/8 W
Max. Operation Voltage	300V	200V	200V	200V	150V	50V	50V
Max. Overload Voltage	500V	400V	400V	400V	300V	100V	100V
Operation Temperature	- 55/+155°C						

Note :

- This is the maximum voltage that may be continuously supplied to the resistor element, see "IEC publication 60115-8"
- Max. Operation Voltage : So called RCWV (Rated Continuous Working Voltage) is determined by  

$$RCWV = \sqrt{\text{Rated Power} \times \text{Resistance Value}}$$
or Max. RCWV listed above, whichever is lower.
- 2W loading with total solder-pad and trace size of 300 mm<sup>2</sup>

**TEST CONDITION FOR JUMPER (0 Ω)**

Item	WF25P	WF20P	WF10P	WF12P	WF08P	WF06P	WF04P
Power Rating	2W	1W	1/2W	1/2W	1/4W	1/8W	1/8W
Resistance	Max. 20mΩ	Max. 20mΩ	Max. 20mΩ	Max. 20mΩ	Max. 20mΩ	Max. 20mΩ	Max. 50mΩ
Rated Current	10A	7A	5A	5A	4A	2A	1.5A
Peak Current	25A	17.5A	12.5A	12.5A	10A	5A	3.8A
Operating Temperature	-55 ~ +155°C						

**MECHANICAL DATA**

Unit: mm

Symbol	WF25P	WF20P	WF12P	WF10P	WF08P	WF06P	WF04P
L	6.30 ± 0.20	5.00 ± 0.20	3.10 ± 0.15	3.10 ± 0.15	2.00 ± 0.10	1.60 ± 0.10	1.00 ± 0.05
W	3.10 ± 0.20	2.50 ± 0.20	1.60 ± 0.15	2.50 ± 0.15	1.25 ± 0.10	0.80 ± 0.10	0.50 ± 0.05
T	0.60 ± 0.15	0.60 ± 0.10	0.55 ± 0.10	0.55 ± 0.10	0.50 ± 0.15	0.45 ± 0.15	0.35 ± 0.05
Tt	0.60 ± 0.25	0.60 ± 0.25	0.50 ± 0.25	0.50 ± 0.25	0.40 ± 0.20	0.30 ± 0.10	0.20 ± 0.10
Tb	1.80 ± 0.25	0.60 ± 0.25	0.50 ± 0.25	0.50 ± 0.25	0.40 ± 0.20	0.30 ± 0.15	0.25 ± 0.10

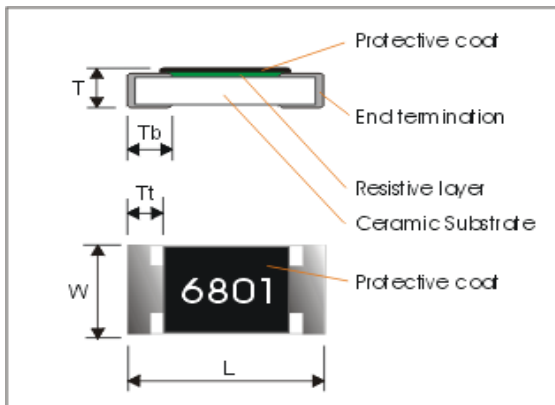

### Recommended Solder Pad Dimensions

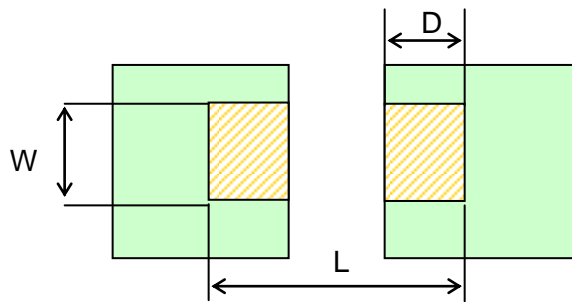

Type	W	D	L
WF25P	3.7mm	2.45mm	7.6mm

### MARKING

For 0603 above size, each resistor is marked with a four-digit for 1% tolerance and three-digit for 5% tolerance on the protective coating to designate the nominal resistance value.

For 0603, each resistor is marked with a three-digit!

For 0402, no marking !

For Jumper, 2512/2010 defines 0000, 1206/0805/0603 defines 000.

Example:

102 = 1kΩ



16R0 = 16Ω



### FUNCTIONAL DESCRIPTION

#### Product characterization

Standard values of nominal resistance are taken from the E96 & E24 series for resistors with a tolerance of ±5% & ±1%. The values of the E24/E96 series are in accordance with "IEC publication 60063".

#### Derating curve

The power that the resistor can dissipate depends on the operating temperature; see Fig.2

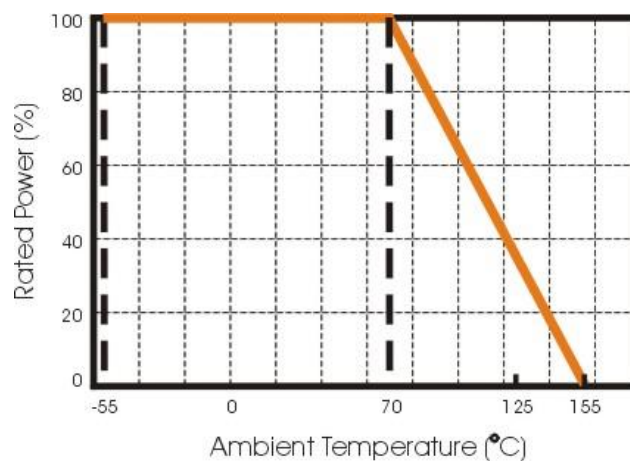

Figure 2 Maximum dissipation in percentage of rated power as a function of the ambient temperature

### MOUNTING

Due to their rectangular shapes and small tolerances, Surface Mountable Resistors are suitable for handling by automatic placement systems.

Chip placement can be on ceramic substrates and printed-circuit boards (PCBs).

Electrical connection to the circuit is by individual soldering condition.

The end terminations guarantee a reliable contact.

### SOLDERING CONDITION

The robust construction of chip resistors allows them to be completely immersed in a solder bath of 260°C for 10 seconds. Therefore, it is possible to mount Surface Mount Resistors on one side of a PCB and other discrete components on the reverse (mixed PCBs).

Surface Mount Resistors are tested for solderability at 235°C during 2 seconds. The test condition for no leaching is 260°C for 30 seconds. Typical examples of soldering processes that provide reliable joints without any damage are given in Fig 3.

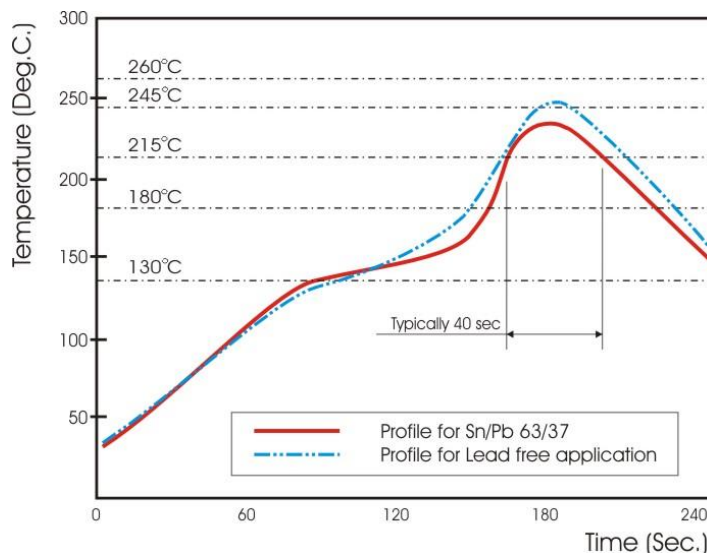

Fig 3. Infrared soldering profile for Chip Resistors

### CATALOGUE NUMBERS

The resistors have a catalogue number starting with .

WF25	P	102	J	T	L
<b>Size code</b>	<b>Type code</b>	<b>Resistance code</b>	<b>Tolerance</b>	<b>Packaging code</b>	<b>Termination code</b>
WF25 : 2512	P :Power	<b>5% E24:</b> 2 significant digits followed by No. of zeros e.g.:	J : ±5%	T : 7" Reel taping	L = Sn base (lead free)
WF20 : 2010	2512 size = 2W	3ohm =3R0	F : ±1%	E : 7" Reel up side down taping	
WF12 : 1206	2010 size = 1W	10ohm =100	D : ±0.5%		
WF10 : 1210	1206 size = 1/2W	56Kohm =563	B : ±0.1%		
WF08 : 0805	1210 size = 1/2W	<b>1% E24+E96:</b> 3 significant digits	P : Jumper		
WF06 : 0603	0805 size = 1/4W	followed by No. of zeros			
WF04 : 0402	0603 size = 1/8W	100Ω =1000			
	0402 size = 1/8W	37.4KΩ =3742			

Tape packaging WF12, WF10, WF08, WF06 : 8mm width paper taping 5,000pcs per reel.

WF04: 8mm width paper taping 10,000pcs per reel.

WF25, WF20: 12mm width plastic taping 4,000pcs per reel.

## TEST AND REQUIREMENTS

Basic specification : JIS C 5201-1 : 1998

TEST	PROCEDURE	REQUIREMENT
<b>Clause 4.8</b> Temperature Coefficient of Resistance (TCR )	Natural resistance change per change in degree centigrade. $\frac{R_2 - R_1}{R_1(t_2 - t_1)} \times 10^6 \text{ (ppm/}^\circ\text{C)}$ R <sub>1</sub> : Resistance at reference temperature R <sub>2</sub> : Resistance at test temperature t <sub>1</sub> : 20°C+5°C-1°C	Refer to quick reference data for T.C.R specification
<b>Clause 4.13</b> Short time overload	5.0× Rated power or Max. Overload Voltage for 5 sec. Measure resistance after 30 minutes..	$\Delta R/R \text{ max. J: } \leq \pm(2\%+0.1\Omega)$ B,D, F: $\leq \pm(1\%+0.05\Omega)$
<b>Clause 4.18</b> Resistance to soldering heat	Un-mounted chips completely immersed for 10±1second in a SAC solder bath at 260°C±5°C	No visible damage $\Delta R/R \text{ max. J: } \leq \pm(1\%+0.1\Omega)$ B,D, F: $\leq \pm(0.5\%+0.05\Omega)$
<b>Clause 4.17</b> Solderability	Un-mounted chips completely immersed for 2±0.5 second in a SAC solder bath at 235°C±5°C	Good tinning (>95% covered) No visible damage
<b>Clause 4.18</b> Leach Test	Un-mounted chips completely immersed for 60±1second in a solder bath at 260°C±5°C	Ditto
<b>Clause 4.19</b> Temperature cycling	30 minutes at -55°C±3°C, 2~3 minutes at 20°C+5°C-1°C, 30 minutes at +155°C±3°C, 2~3 minutes at 20°C+5°C-1°C, total 5 continuous cycles	No visible damage $\Delta R/R \text{ max. J } \leq \pm(1\%+0.1\Omega)$ B,D,F $\leq \pm(0.5\%+0.05\Omega)$
<b>Clause 4.25</b> Load life (endurance)	1000 +48/-0 hours, loaded with RCWV or Vmax in chamber controller 70±2°C, 1.5 hours on and 0.5 hours off	No visible damage $\Delta R/R \text{ max. J } \leq \pm(3\%+0.1\Omega)$ B,D,F $\leq \pm(1\%+0.05\Omega)$
<b>Clause 4.24</b> Load life in Humidity	1000 +48/-0 hours, loaded with RCWV or Vmax in humidity chamber controller at 40°C±2°C and 90~95% relative humidity, 1.5hours on and 0.5 hours off	No visible damage $\Delta R/R \text{ max. J } \leq \pm(3\%+0.1\Omega)$ B,D,F $\leq \pm(1\%+0.05\Omega)$
<b>Clause 4.33</b> Bending strength	Resistors mounted on a 90mm glass epoxy resin PCB(FR4); bending : 2 mm(2512;2010) 3mm(1206), once for 10 seconds	No visible damage $\Delta R/R \text{ max. J } \leq \pm(1\%+0.1\Omega)$ B,D,F $\leq \pm(0.5\%+0.05\Omega)$
<b>Clause 4.32</b> Adhesion	Pressurizing force: 5N, Test time: 10±1sec	No remarkable damage or removal of the terminations
Insulation Resistance <b>Clause 4.6</b>	Apply the maximum overload voltage (DC) for 1minute	R ≥ 10GΩ
Dielectric Withstand Voltage <b>Clause 4.7</b>	Apply the maximum overload voltage (AC) for 1 minute	No breakdown or flashover

## PACKAGING

Paper Tape(WF12P, WF10P, WF08P, WF06P, WF04P) & Plastic Tape(WF25P;WF20P)

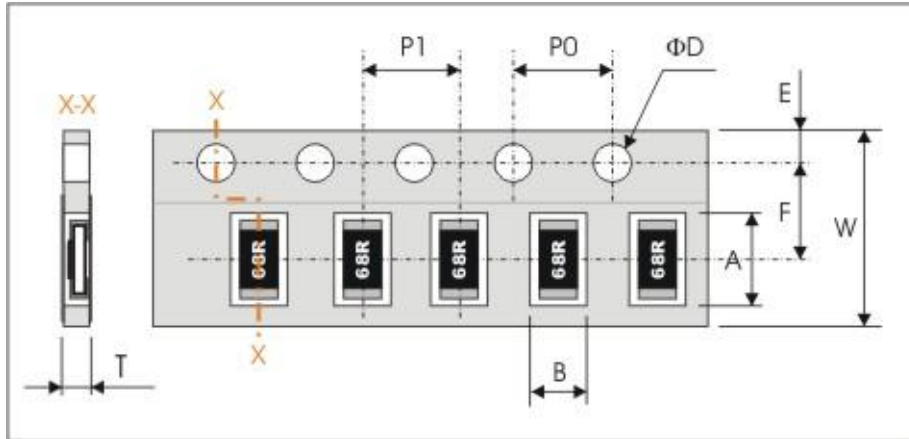

(unit :mm)

Series No.	A	B	W	F	E
WF25P	6.90±0.20	3.60±0.20	12.00±0.30	5.50±0.10	1.75±0.10
WF20P	5.50±0.20	2.80±0.20			
WF12P	3.60±0.20	2.00±0.20	8.00±0.30	3.50±0.20	1.75±0.10
WF10P	3.60±0.20	3.00±0.20	8.00±0.30	3.50±0.20	1.75±0.10
WF08P	2.40±0.20	1.65±0.20	8.00±0.30	3.50±0.20	1.75±0.10
WF06P	1.90±0.20	1.10±0.20	8.00±0.30	3.50±0.20	1.75±0.10
WF04P	1.20±0.10	0.70±0.10	8.00±0.30	3.50±0.20	1.75±0.10

Series No.	P1	P0	ΦD	T
WF25P	4.00±0.10	4.00±0.10	Φ1.50 <sup>+0.1</sup> <sub>-0.0</sub>	Max. 1.2
WF20P				Max. 1.0
WF12P				Max. 1.0
WF10P	4.00±0.10	4.00±0.10	Φ1.50 <sup>+0.1</sup> <sub>-0.0</sub>	Max. 1.0
WF08P	4.00±0.10	4.00±0.10	Φ1.50 <sup>+0.1</sup> <sub>-0.0</sub>	Max. 1.0
WF06P	4.00±0.10	4.00±0.10	Φ1.50 <sup>+0.1</sup> <sub>-0.0</sub>	0.65±0.05
WF04P	2.00±0.10	4.00±0.10	Φ1.50 <sup>+0.1</sup> <sub>-0.0</sub>	0.40±0.05

### Reel dimensions



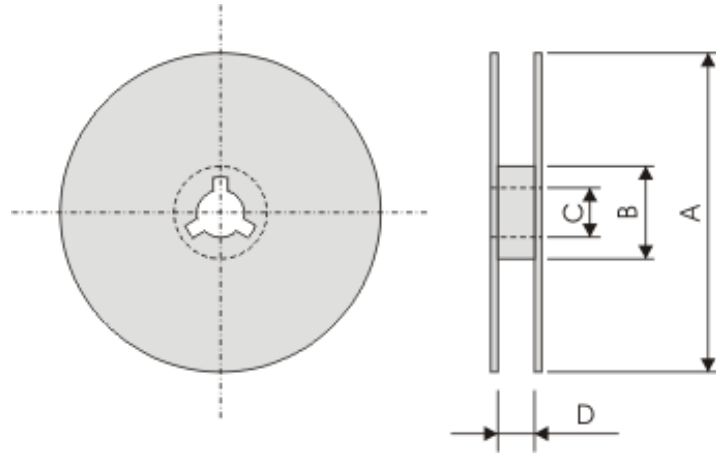

(unit : mm)

Reel / Tape	A	B	C	D
7" reel for 12mm tape	Φ178.0±2.0	Φ60.0±1.0	13.0±0.2	12.4±1.0
7" reel for 8mm tape				9.0±0.5