



2/2 or 3/2-way Solenoid Valve, with pivoted armature and isolating diaphragm

- Lockable manual override as standard
- For liquid, gaseous and aggressive media
- Long service life, even in non-lube conditions
- Insensitive to contaminated fluids
- Analysis version available

Type 0330 can be combined with...



Type 2508

Cable plug



Type 1078

Timer unit



Type 2511

ASI cable plug

The Type 0330 is a direct-acting 2/2 or 3/2-way pivoted armature solenoid valve with a wide range of circuit functions. The magnetic system and the medium are separated by a diaphragm system. The valve is fast-acting and has a long service life, even in non-lube conditions.

Circuit functions

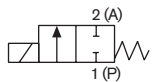

A 2/2-way valve NC

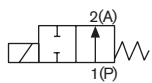

B 2/2-way valve NO

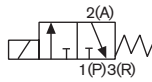

C 3/2-way valve NC

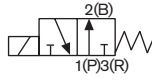

D 3/2-way valve NO

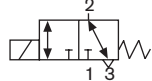

T 3/2-way valve, universal function, any flow direction

Applications

- Water and gas analysis
- Pharmaceutical industry
- Food processing

Technical data	
Port connection	G 1/4 (G 1/8, NPT on request)
Orifice	DN 2.0 - 4.0
Body and seat materials	Brass and stainless steel 1.4401
Coil material	Epoxy
Coil insulation class	H
Seal material	NBR and FKM (EPDM, FFKM on request)
Media	
NBR	Neutral media, such as compressed air, water, hydraulic oil
FKM	Hot air, oxygen, hot oil, per-solution
on request EPDM	Oil and fat-free media
on request FFKM	Hot air, oxygen, hot oil, per-solution
Media temperature	
NBR	0 to +80 °C
FKM	0 to +90 °C
on request EPDM	-30 to +90 °C
on request FFKM	+5 to +90 °C
Ambient temperature	max. +55 °C (min. temperature see media temp.)
Viscosity	max. 37 mm ² /s
Operating voltage	24 V DC, 24 V/50 Hz, 230 V/50 Hz further on request
Voltage tolerance	±10%
Duty cycle	100% continuous rating
Electrical connection	Cable plug Type 2508 (DIN EN 175301-803 Form A) for Ø 7 mm cable (supplied as standard)
Protection class	IP 65 with cable plug
Weight [kg]	0.47
Installation	As required, preferably with actuator upright

Technical data, cont.

Power ratings

Orifice [mm]	Power ratings			
	Inrush AC [VA]	Hold AC (hot coil) [VA]	[W]	Hot/cold coil DC [W]
2-4	30	15	8	8 / 11

Response times

Orifice [mm]	Response times			
	AC Opening [ms]	Closing [ms]	DC Opening [ms]	Closing [ms]
2-4	8-15	8-15	10-20	10-20

Response times [ms]:

Measured at valve outlet at 6 bar and +20 °C

Opening: pressure build-up 0 to 90%, closing: pressure relief 100 to 10%

Materials

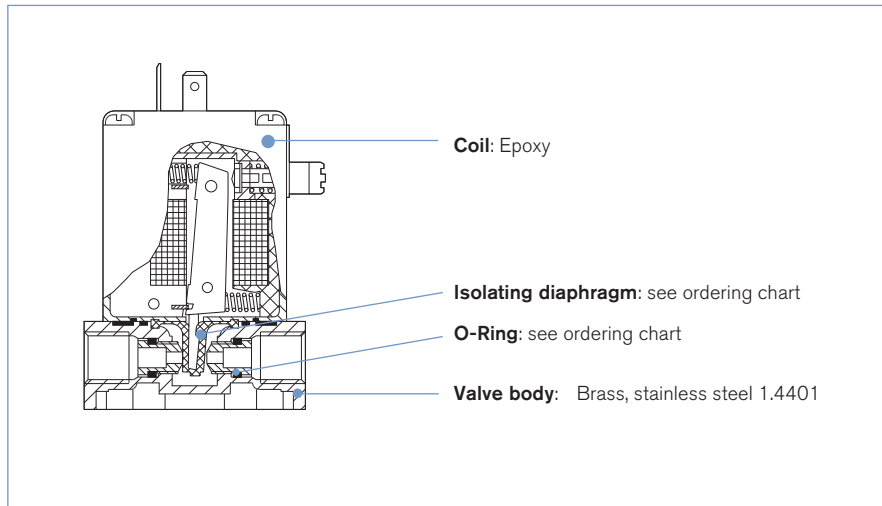

Ordering chart for valves (other versions on request)

Brass or stainless steel body, seal material NBR or FKM, manual override and cable plug included

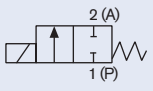
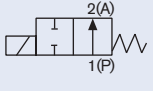
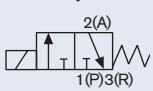
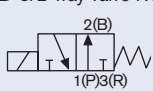
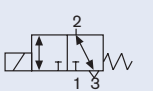
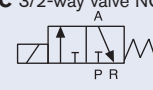
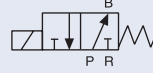
Circuit function	Port connection threaded port	Orifice [mm]	Kv value water [m ³ /h] ^{1), 4)}		Pressure range [bar] ²⁾	Seal material	Item no. per voltage/frequency [V/Hz]		
			DC	AC			024/DC	024/50	230/50
A 2/2-way valve NC ³⁾ 	Brass body								
	G 1/4	3.0	0.14	0.18	0-10	FKM	020 293	022 883	124 909
		4.0	0.17	0.23	0-5	NBR	020 294	086 553	024 902
	G 1/4	3.0	0.14	0.18	0-10	FKM	024 019	025 246	124 912
		4.0	0.17	0.23	0-5	NBR	025 084	–	046 007
	Stainless steel body								
G 1/4	3.0	0.14	0.18	0-10	FKM	020 292	023 984	024 563	
	4.0	0.17	0.23	0-5	FKM	018 276	018 857	020 873	
B 2/2-way valve NO ³⁾ 	Brass body								
	G 1/4	3.0	0.14	0.18	0-10	FKM	141 917	130 146	141 919
		4.0	0.17	0.23	0-5	FKM	141 920	141 921	141 923
	G 1/4	3.0	0.14	0.18	0-10	FKM	141 928	141 929	141 931
		4.0	0.17	0.23	0-5	FKM	141 932	141 933	141 935
	Stainless steel body								
G 1/4	3.0	0.14	0.18	0-10	FKM	141 928	141 929	141 931	
	4.0	0.17	0.23	0-5	FKM	141 932	141 933	141 935	
C 3/2-way valve NC 	Brass body								
	G 1/4	2.0	0.08	0.11	0-16	NBR	041 103	042 129	041 105
		3.0	0.14	0.18	0-10		041 107	041 108	041 116
		4.0	0.17	0.23	0-5		042 218	042 695	042 329
	Stainless steel body								
	G 1/4	3.0	0.14	0.18	0-10	FKM	052 344	045 024	052 059
4.0		0.17	0.23	0-5	FKM	050 483	043 324	050 979	
D 3/2-way valve NO 	Brass body								
	G 1/4	2.0	0.08	0.11	0-16	NBR	056 984	041 858	041 137
		3.0	0.14	0.18	0-10		041 139	041 141	041 147
		4.0	0.17	0.23	0-5		043 129	042 696	042 903
	Stainless steel body								
	G 1/4	2.0	0.08	0.11	0-12	FKM	124 922	138 316	124 925
3.0		0.14	0.18	0-8	FKM	124 927	124 928	124 930	
T 3/2-way valve, universal function, any flow direction 	Stainless steel body								
	G 1/4	2.0	0.08	0.11	0-12	FKM	124 932	124 933	124 935
3.0		0.14	0.18	0-8	FKM	124 937	124 938	124 940	
Vacuum version									
C 3/2-way valve NC 	Brass body								
	G 1/4	3.0	0.14	0.18	Vac. -6	NBR	043 894	046 815	–
		4.0	0.17	0.23	Vac. -3		044 302	–	042 879
D 3/2-way valve NO 	Brass body								
	G 1/4	4.0	0.17	0.23	Vac. -3	NBR	052 680	059 646	053 785

¹⁾ Measured at +20 °C, 1 bar²⁾ pressure at valve inlet and free outlet. ²⁾ Pressure data [bar]: Overpressure with respect to atmospheric pressure

³⁾ The listed Item no. and circuit functions have a valve body with a straight through channel (var. code AF02)

⁴⁾ In DC-versions with orifice 3.0 and 4.0 the orifice diameter is reduced by about 0,5mm.

i Further versions on request



Approvals

Explosion protection (Type 780), ATEX, UL, UR, FM - Ex Div. 1



Voltage

Non-standard voltages



Materials

Seal materials EPDM, FFKM



Circuit function

E (mixing) or F (distributing)



Port connection

NPT, G 1/8



Additional

Impulse version, optical or electrical position feedback (type 1060), further device combinations

Technical data – Analysis version

Analysis version	Media flowing through is not contaminated, for pure media
Carbon residue threshold	< 0.2 mg/dm ²
Permissible leakage rate Media	10 ⁻⁴ mbar l/sec <ul style="list-style-type: none"> ▪ neutral / aggressive Media, which do not attack the body and seal material ▪ technical vacuum
Electrical connection	Tag connector acc. to DIN EN 175301-803 A (previously DIN43650) for cable plug Type 2508 (see accessories)
Mounting instruction	No oil, fat or silicon used whatsoever in mounting

Solenoid valve for higher requirements

This version is particularly suitable for switching from extremely pure gaseous and liquid media. All contaminated parts are subjected to additional purification processes, so that the media is not under any circumstances contaminated. The assembly takes place under cleanroom conditions.

Tightness tested on helium leak detector, 10⁻⁴ mbar l/sec.

Ordering chart for valves, analysis and vacuum version (other versions on request)

Stainless steel body, seal material FKM or NBR, manual override and without cable plug (see Accessories)

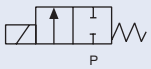
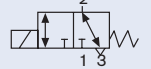
Circuit function	Port connection threaded port	Orifice [mm]	Kv value water [m ³ /h] ^{1) 4)}		Pressure range [bar] ²⁾	Seal material	Item no. per voltage/frequency [V/Hz]		
			DC	AC			(DC)	024/DC	024/50
Analysis version									
A 2/2-way valve NC³⁾									
	Stainless steel body								
	G 1/4	2.0	0.08	0.11	Vac. -10	FKM	137 839	–	137 842
		3.0	0.14	0.18	Vac. -6		137 843	–	137 846
G 1/4	4.0	0.17	0.23	Vac. -3	FKM	122 101	–	137 849	
T 3/2-way valve, universal function, any flow direction									
	Stainless steel body								
	G 1/4	2.0	0.08	0.11	Vac. -8	FKM	137 850	–	137 854
		3.0	0.14	0.18	Vac. -5		FKM	137 855	–
G 1/4	4.0	0.17	0.23	Vac. -3	FKM	137 859	–	137 862	

¹⁾ Measured at +20 °C, 1 bar²⁾ pressure at valve inlet and free outlet. ²⁾ Pressure data [bar]: Overpressure with respect to atmospheric pressure

³⁾ The listed item nos. have a valve body with straight through channel ⁴⁾ In DC-versions with orifice 3.0 and 4.0 the orifice diameter is reduced by about 0.5mm.

Please note that the cable plug has to be ordered separately, see Accessories on next page and separate datasheet for Type 2508.

Other circuit functions

The valves are fitted with different springs. When used in other circuit functions the permissible operating pressure changes acc. to the following table.

Circuit function	Max. operating pressure [bar] for valve use in other circuit functions																	
	Orifice 2						Orifice 3						Orifice 4					
	A	B	C	D	E	F	A	B	C	D	E	F	A	B	C	D	E	F
C	16	1.5	16	1.5	1.5	16	10	1	10	1	1	10	5	0.8	5	0.8	0.8	5
D	4	26	4.5	16	4	4	2.5	10	2.5	10	2	3	2	5	2	5	2	2
T	8	8	10	10	10	8	6	6	6	6	6	6	3	3	3	3	3	3

Ordering chart Accessory

Cable plug acc. to DIN EN 175301-803 Form A

	Circuitry	Voltage / frequency	Item no.
	None (standard)	0 - 250 V AC/DC	008 376
	with LED	12 - 24 V AC/DC	008 360
	with LED and varistor	12 - 24 V AC/DC	008 367
	with rectifier, LED and varistor	12 - 24 V AC/DC	008 363
	with LED	200 - 240 V	008 362
	with LED and varistor	200 - 240 V	008 369
	further versions see datasheet Type 2508		

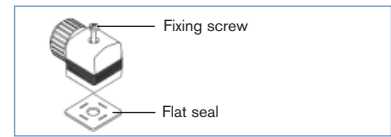

The delivery of a cable plug includes the flat seal and the fixing screw. For other cable plug versions acc. to DIN EN 175301-803 Form A (previously DIN 43650), see data-sheet Type 2508.

Dimensions [mm]

Possible body connections			
Circuit function	1	2	3
A ¹⁾	P	A	–
B ¹⁾	A	P	–
C	P	A	R
D	R	B	P
E	P1	A	P2
F	A	P	B

The connections marked with 1, 2 and 3 are labelled in the drawing according to the circuit function table on the left.

¹⁾ The listed Item no. and circuit functions have a valve body with a straight through channel (var. code AF02)

2/2-way valve

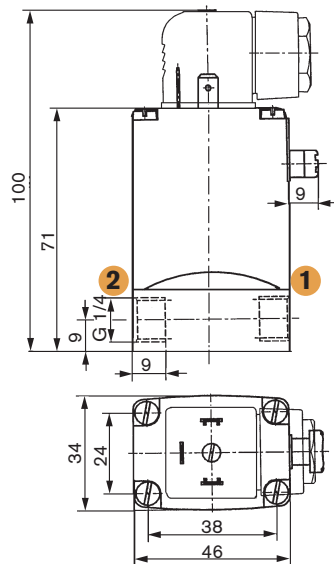

3/2-way valve

