

REV.	ECN NO.	DATE	SIGN	DESCRIPTION
A	Initial Release	2018/03/12	Mafei	Change Rev.01 To Rev.A

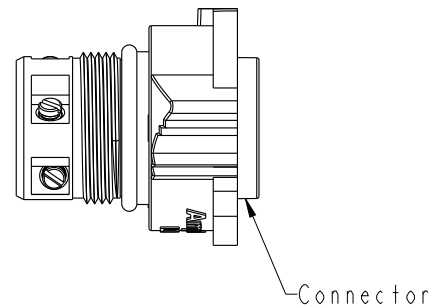
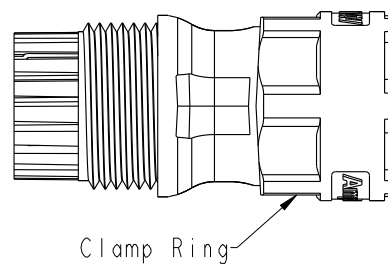
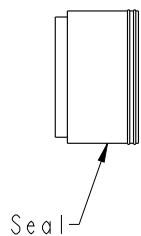
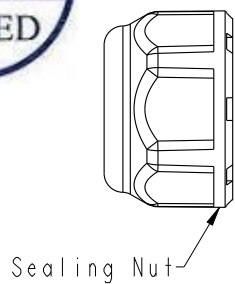

**Material Specification:**

- \* Connector: Thermoplastic
- \* Terminal: Copper Alloy, Gold Plated.
- \* Gasket & O-Ring: Rubber.
- \* UL Rated: UL 94V-0, fl.
- \* RoHS Compliant.

**Electrical Specification:**

- \* Contact Resistance: 10mΩ Max.
- \* Insulation Resistance: 100MΩ Min.
- \* Dielectric Withstand Voltage: 1,600 Vac.

**Mechanical Specification:**

- \* Durability: 1000 Cycles.
- \* Tensile strength: 10 kgf.
- \* Wire conductor: 14#~12#(2.0mm<sup>2</sup>~3.3mm<sup>2</sup>).
- \* Wire insulation OD: Max 4.0mm.
- \* Torque Force for Clamp Ring: 6~8 kgf-cm
- \* Torque Force for Seal Nut: 8~15 kgf-cm
- \* Torque Force for Screw: 4~5 kgf-cm

**Environmental Specification:**

- \* Waterproof Rating: IP68(Mated, 1M/24 Hours)
- \* Temperature Range: -40°C to 105°C.
- \* Salt Spray: Mated, 500 Hours.
- \* Safety Compliance: UL 1977.

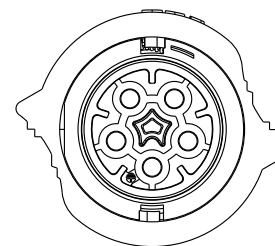
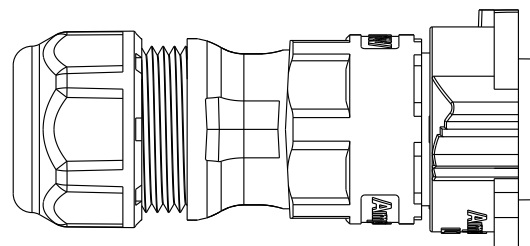
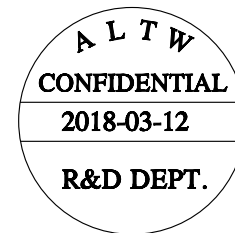
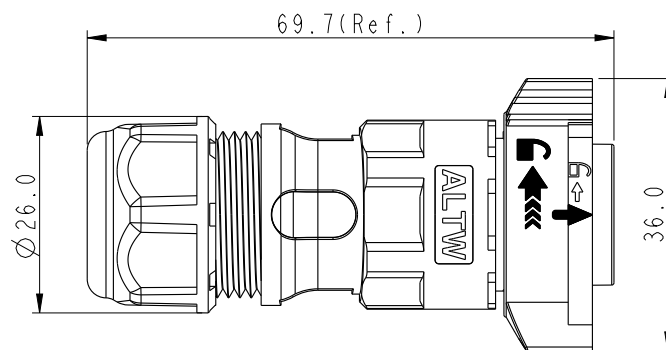

UNIT:mm		
TOLERANCE		
±0.5 mm		

TITLE X-Lok D-Size Field Installable Cable Screw-In Type F Conn M Pin			
SCALE 8:5	SIZE A4	SHEET 1 OF 2	
REV. A	WC-REV. A.3	QC: Inspection item	

**Amphenol LTW**  
安費諾亮泰企業股份有限公司

ITEM NO	DRAWN BY Mafei	DATE 2018-03-12
DWG NO DC-XXBFMB-QL8XPP	CHECKED BY Jerry	DATE 2018-03-12
CUSTOMER ALTW	APPROVED BY Max	DATE 2018-03-12

THIS DOCUMENT IS SUBJECT TO CHANGE WITHOUT NOTICE. IT IS CONFIDENTIAL AND A PROPERTY OF Amphenol LTW. DISCLOSURE TO THIRD PARTY HAS TO BE AUTHORIZED BY Amphenol LTW.

THIS DOCUMENT IS SUBJECT TO CHANGE WITHOUT NOTICE. IT IS CONFIDENTIAL AND A PROPERTY OF Amphenol LTW. DISCLOSURE TO THIRD PARTY HAS TO BE AUTHORIZED BY Amphenol LTW.



Ordering Information:

DC-XXBFMB-QL8XPP

Number of Contacts

- 02
- 03
- 05

- S: With Red Color Seal 1, Cable OD 8.0~10.0mm.
- M: With Yellow Color Seal 2, Cable OD 10.0~12.0mm.
- L: With Blue Color Seal 3, Cable OD 12.0~14.0mm.
- A: With Seal 1 & Seal 2 & Seal 3.

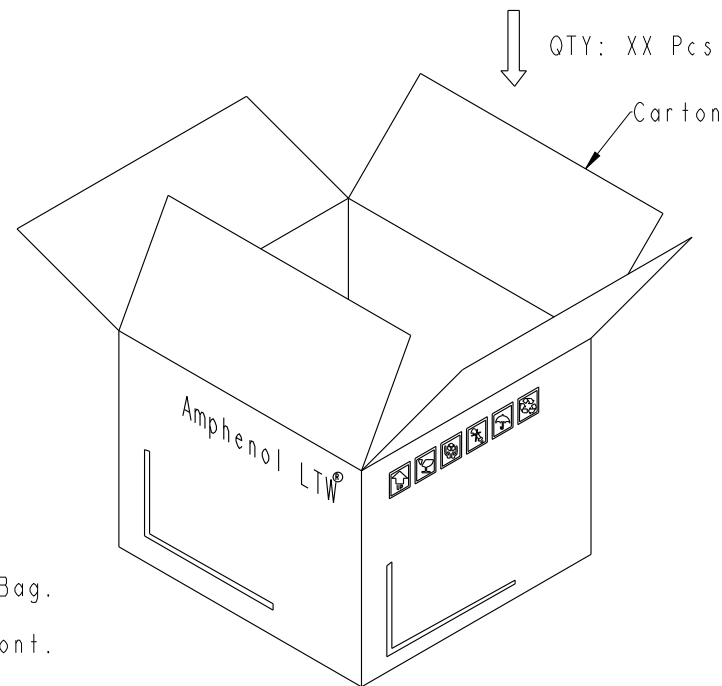
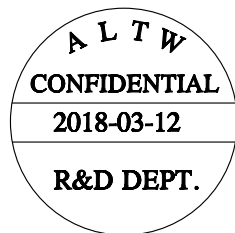
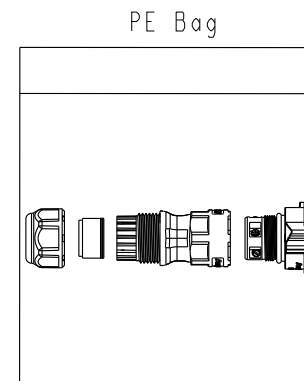
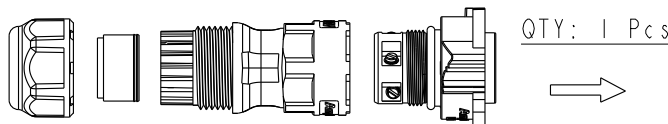

Note:

- \* One Set Unassembled In One PE Bag.  
(每一組未組裝, 放置於一個PE袋, 並封口, 如圖示)
- \* Label is Attached To PE Bag Front.  
(標籤貼在PE袋正面)

	20A ; 300Vac/Vdc 5 Contacts(05)
	20A ; 300Vac/Vdc 3 Contacts(03)
	20A ; 300Vac/Vdc 2 Contacts(02)

UNIT:mm		TITLE X-Lok D-Size Field Installable Cable Screw-In Type M Conn F Pin	
TOLERANCE ±0.5 mm	SCALE 8:5	SIZE A4	SHEET 2 OF 2
REV. A	WC-REV. A.3	QC: Inspection item	

**Amphenol LTW**  
安費諾亮泰企業股份有限公司

ITEM NO	DRAWN BY Mafei	DATE 2018-03-12
DWG NO DC-XXBFMB-QL8XPP	CHECKED BY Jerry	DATE 2018-03-12
CUSTOMER ALTW	APPROVED BY Max	DATE 2018-03-12