

PLEASE CHECK WWW.MOLEX.COM FOR LATEST PART INFORMATION

Part Number: [1053252006](#)
Status: **Active**
Overview: [Nano-Fit Power Connectors](#)
Description: Nano-Fit Terminal Position Assurance (TPA) Retainer, 2.50mm Pitch, 6 Circuits, Natural

Documents:

3D Model	Test Summary 1053000000-TS-000 (PDF)
Drawing (PDF)	RoHS Certificate of Compliance (PDF)
Product Specification PS-105300-100-001 (PDF)	Product Literature (PDF)
Packaging Specification PK-105325-100-000 (PDF)	

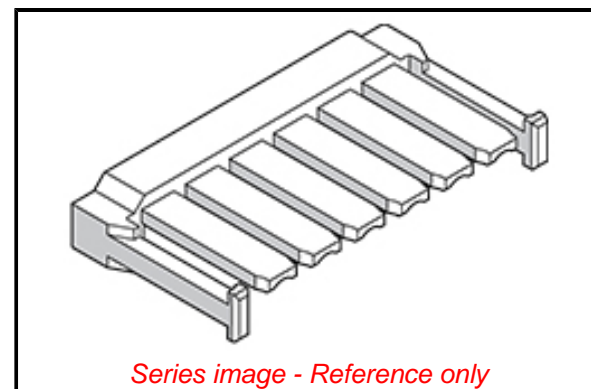

General

Product Family	Accessories
Series	105325
Comments	Operating temperature is -40#C to +105#C for tin and -40#C to +115#C for gold
Component Type	Terminal Position Assurance
Overview	Nano-Fit Power Connectors
Product Literature Order No	987651-1223
Product Name	Nano-Fit, TPA - Term Pos Assurance
UPC	889056029162

Physical

Circuits (Loaded)	6
Circuits (maximum)	6
Color - Resin	Natural
Lock to Mating Part	Yes
Material - Resin	Nylon
Net Weight	0.160/g
Number of Rows	1
Packaging Type	Bag
Temperature Range - Operating	-40°C to +105°C, -40°C to +115°C

Material Info

Reference - Drawing Numbers

Packaging Specification	PK-105325-100-000
Product Specification	PS-105300-100-001
Sales Drawing	SD-105325-100-000
Test Summary	1053000000-TS-000

EU ELV

Not Relevant

EU RoHS

Compliant

REACH SVHC

Not Contained Per - ED/30/2017 (7 July 2017)

Halogen-Free

Status

Low-Halogen

Need more information on product environmental compliance?

Email productcompliance@molex.com
Please visit the [Contact Us](#) section for any non-product compliance questions.

China ROHS

ELV

RoHS Phthalates

Green Image

Not Relevant

Not Contained

Search Parts in this Series

[105325](#) Series

Use With

Nano-Fit TPA Receptacle Housing [105307](#) , [105308](#)