



THE RANGE AT A GLANCE

# LEDVANCE LED LUMINAIRES

OCTOBER 2019



[LEDVANCE.CO.UK](http://LEDVANCE.CO.UK)



**LEDVANCE**

# CONTENTS

## LEDVANCE LUMINAIRE PORTFOLIO: WHAT'S NEW IN 2019?

04

### DOWNLIGHTS

Downlight Comfort	09
Downlight Alu	09
Downlight Alu DALI	10
Downlight Slim Alu	10
Downlight Alu Emergency	11
Downlight Slim Square & Round	12
Downlight Slim Square & Round Frame	13



08

**STANDARD APPLICATIONS:** Public Areas | Shops | Stairways | Corridors  
Foyers | Bathrooms | Kitchens

### PANEL LUMINAIRES

Panel IndiviLED® DALI	29
Panel IndiviLED® Emergency	30
Panel IP54	30
Panel IP54 DALI	31
Panel Performance High Output	31
Panel Performance / High Output DALI	32
Panel Performance UGR<19 / DALI	33
Panel Performance DALI UGR<19	34
UK Panel Performance	34
Panel Value	35
Panel Value Emergency	35
Panel Accessories	36



28

### SPOTLIGHTS

Spot Vario	15
Spot Multi	15
Spot Square Adjust	16
Spot Adjust	16
Spot Adjust DALI / Fireproof DIM	17
Spot Fireproof / Spot DIM	18
Spot Darklight / GU10 Kit	19



14

**STANDARD APPLICATIONS:** Shops | Sales Rooms | Fashion Stores  
Hotels | Cafés | Restaurants | Galleries | Museums

**STANDARD APPLICATIONS:** General Indoor Lighting | Public Buildings  
Offices | Conference Rooms | Corridors

### SUSPENDED LUMINAIRES

Panel Direct/Indirect 1200	
UGR<19 / DALI	39
Linear IndiviLED® Direct/Indirect	40
Linear IndiviLED® Direct/Indirect Sensor	41
Linear IndiviLED	
Emergency / Through-wired	42



38

### TRACKLIGHTS

Tracklight Spot Compact	21
Tracklight Zoom DIM	21
Tracklight Spot	22
Tracklight Spot Reflector	23



20

**STANDARD APPLICATIONS:** Shops | Fashion Stores | Boutiques  
Department Stores | Hotels | Cafés | Galleries | Museums | Showrooms

**STANDARD APPLICATIONS:** General Indoor Lighting | Offices | Libraries  
Schools | Corridors | Entrance Areas

### LINEAR LUMINAIRES

Linear IndiviLED® Direct / DALI	45
Linear IndiviLED® Direct Sensor / DALI	46
Linear IndiviLED® Direct	
Emergency / Through-wired	47
Linear Ultra Output	48
Linear Compact Switch	50
Linear Compact High Output / Batten	51



44

### WALL AND CEILING LUMINAIRES

Surface Compact IK10	25
Surface Circular Sensor	25
Surface Circular	26
Surface Circular Cover	26



24

**STANDARD APPLICATIONS:** Public Areas | Walkways | Stairways  
Bathrooms | Foyers

**STANDARD APPLICATIONS:** Public Buildings | Corridors | Entrance Areas  
Stairwells | Cove Lighting | Shelving

### TRUNKING SYSTEMS

TruSys® Performance	53
TruSys® Performance DALI	54
TruSys® Performance Energy Rail & Accessories	55
TruSys®	58
TruSys® DALI	59
TruSys® Energy Rail & Accessories	60



52

**STANDARD APPLICATIONS:** Factories | Warehouses | Workshops

All the LED luminaires are equipped with high-quality LED modules in the highest energy efficiency classes (A, A+ and A++). Energy efficiency class (EEC) on a scale of A++ (highest efficiency) to E (lowest efficiency). The luminaires contain built-in LED modules. They cannot be changed in the luminaire. All the following values for the IP and IK protection classes apply exclusively to luminaires (excluding accessories).

## DAMP-PROOF LUMINAIRES

Damp Proof Compact IP66	63
Damp Proof	63
Damp Proof DALI / Through-wiring	64
Damp Proof Emergency	65
Damp Proof Special	65
Damp Proof Slim Value	66
Damp Proof Value	66
Damp Proof Housing	67



62

**STANDARD APPLICATIONS:** Factories and Warehouses | Parking Lots  
Underpasses | Garages | Workshops | Production Lines

## OUTDOOR DECORATIVE LUMINAIRES

Facade and pathway luminaires	79
-------------------------------	----



78

**STANDARD APPLICATIONS:** Residential Buildings | Hotels | Office Parks

## HIGH-BAY LUMINAIRES

High Bay DALI	69
High Bay DALI Accessories	70
High Bay	70



68

**STANDARD APPLICATIONS:** Warehouses | Logistics Centres | Industry  
High Ceilings (e.g. Airports)

## EMERGENCY LIGHTING

Emergency Downlight	83
Emergency Exit Sign	84
Emergency Exit Sign Accessories	85
Emergency Conversion Box	85



80

**STANDARD APPLICATIONS:** Escape Routes (Corridors) | Open Areas (Anti-Panic) | Public Buildings | Shops | Offices

## FLOODLIGHTS

Floodlight Performance	73
Floodlight 100DEG	74
Floodlight Sensor	75
Floodlight Photocell Sensor	76
Floodlight Value Floodlight	76
Value Sensor	77



72

**STANDARD APPLICATIONS:** Building Facades | Public Areas  
Construction Sites | Parking Lots | Underpasses

## FURTHER INFORMATION ON LEDVANCE AND ABBREVIATIONS

95

# MORE LIGHT, MORE INNOVATION, THE NEW LED LUMINAIRES FROM

## YOUR PARTNER ON THE LIGHTING MARKET

Professionals need strong partners. A partner like LEDVANCE. Our mission is to offer installers and lighting professionals the products and services they need to be successful. Whether it's the choice of products, the range of services or the latest technical innovations, you can rely on LEDVANCE.

Here, then, is an expanded portfolio for a wide variety of applications covering everything from industrial premises and office buildings to shops and hotels. The new Floodlight Performance range, for example, offers three different light distribution patterns for optimum customized illumination. The dimmable Tracklight Spot Zoom with the manual zoom lens is a versatile spotlight for various shop applications. And the Panel Direct/Indirect with its ideal mix of direct and indirect light makes any office a more comfortable place in which to work.



## SCALE – AWARD-WINNING LUMINAIRE DESIGN

Design makes products unique – like our individual, aesthetic and functional SCALE design language. It combines unique luminaire design with tangible value in every product and takes the modern tonality of the LEDVANCE brand into new territory. A fascinating combination of form and function, which is loved not only by our customers – as the 2019 German Design Award proves.

# MORE OPPORTUNITIES – LEDVANCE

## WE ADVANCE LIGHT – FOR YOU AS WELL

LEDVANCE stands for high quality LED luminaires. The luminaires are impressive for their simple installation, high energy efficiency and high quality of light – at a very good price/performance ratio and with a guarantee<sup>1</sup> of up to 5 years.

This is supplemented by a service that is tailored to your needs. We have a global supplier and sales network so we can support you wherever you are. All the product information is also available online. And we can assist you with planning your lighting system – from the initial consultation to technical support.

<sup>1</sup> Refer to [www.ledvance.co.uk/guarantee](http://www.ledvance.co.uk/guarantee) for precise conditions

## THE BENEFITS FOR LEDVANCE CUSTOMERS:



Global  
network



Broad portfolio  
from a single  
source



Outstanding  
services



## YOUR WISHES ARE OUR STANDARD

We are constantly evolving – and thanks to the targeted expansion of our product range, LEDVANCE can now cover more and more lighting projects entirely from a single source.

We always have our eyes on developments on the lighting market and your wishes as lighting professional. So we continue to be your reliable partner for high-quality lighting.



GERMAN  
DESIGN  
AWARD  
WINNER  
2019

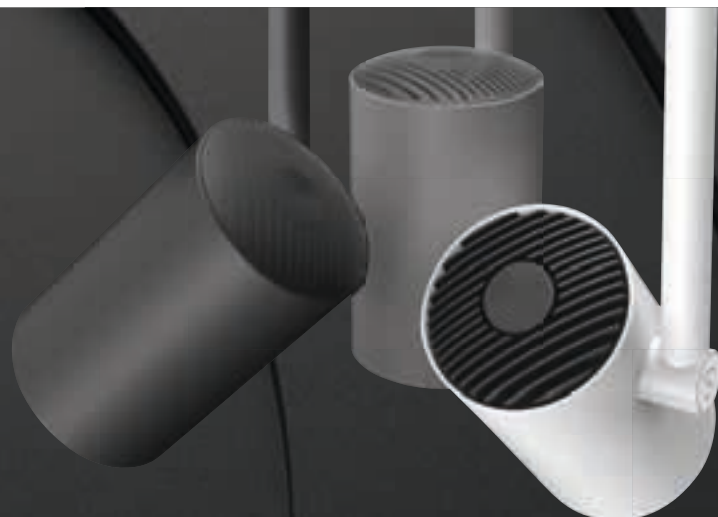

# IDEAL LIGHTING SOLUTIONS IN APPLICATIONS



## SHOP

AESTHETICS MEETS FUNCTIONALITY:  
SHOP LUMINAIRES



TRACKLIGHT  
SPOT  
Page 22



SPOT VARIO  
Page 15



SPOT MULTI  
Page 15



TRUSYS®  
Page 58



LINEAR  
COMPACT HO  
Page 51



EMERGENCY  
DOWNLIGHT  
Page 83



## OFFICE

LIGHT AS A FACTOR FOR SUCCESS:  
OFFICE LUMINAIRES



DOWNLIGHT  
COMFORT  
Page 09



DOWNLIGHT  
ALU  
Page 09



PANEL  
PERFORMANCE  
Page 32



LINEAR  
INDIVILED®  
Page 45



LINEAR  
COMPACT  
Page 50



EMERGENCY  
EXIT SIGN  
Page 84

# USE:

## HOSPITALITY

WELL-BEING, INCLUDING:  
HOSPITALITY LUMINAIRES



**SPOT ADJUST**  
Page 16



**SPOT MULTI**  
Page 15



**SPOT SQUARE  
DK ADJUST**  
Page 16



**SURFACE  
COMPACT IK10**  
Page 25



**EMERGENCY EX-  
IT SIGN**  
Page 84



**EMERGENCY  
DOWNLIGHT**  
Page 83



## INDUSTRY

HARD WORKERS:  
INDUSTRY LUMINAIRES



**DAMP PROOF  
COMPACT**  
Page 63



**TRUSYS®  
PERFORMANCE**  
Page 53



**DAMP PROOF**  
Page 63



**HIGH BAY DALI  
CLO**  
Page 69



**DAMP PROOF  
SPECIAL**  
Page 65



**LINEAR ULTRA  
OUTPUT**  
Page 48



# DOWNLIGHTS

## LEDVANCE DOWNLIGHT COMFORT: ONE LUMINAIRE, THREE OPTIONS



On the **Downlight Comfort** you can switch between three light colours (3000/4000/5700 K).

**Another benefit:** Wholesalers and installers minimize their stock risks because they always have a luminaire with the right light colour in stock.







## DOWNLIGHT COMFORT



Product name	Static Code	GTIN (EAN)	W	lm	lm/W	°	L70 <sup>2</sup>	L80 <sup>2</sup>	IK	L x W x H [mm] Ø x H [mm]
--------------	-------------	------------	---	----	------	---	------------------	------------------	----	------------------------------

### DOWNLIGHT COMFORT

NEW	DL COMFORT DN 130 13 W 3CCT IP54 WT	DLCOMF130TW	4058075104068	13	1030...1210	85	60	50.000	43.000	IK03	145 x 82
NEW	DL COMFORT DN 155 18 W 3CCT IP54 WT	DLCOMF155TW	4058075104082	18	1040...1620	85	60	50.000	43.000	IK03	172 x 95
NEW	DL COMFORT DN 205 20 W 3CCT IP54 WT	DLCOMF205TW	4058075104105	20	1720...1930	90	60	50.000	43.000	IK03	228 x 98

- Three light colour in one luminaire: Warm White, Cool White, Daylight White
- Simple installation thanks to integrated driver
- Easy installation with fast connection



## DOWNLIGHT ALU



Product name	Static Code	GTIN (EAN)	W	lm	lm/W	°	L70 <sup>2</sup>	L80 <sup>2</sup>	IK	L x W x H [mm] Ø x H [mm]
--------------	-------------	------------	---	----	------	---	------------------	------------------	----	------------------------------

### DOWNLIGHT ALU

DL ALU DN	150 14 W 3000 K IP44 WT	DLALU1430	4058075091436	14	1190	85	100	50.000	45.000	IK02	160 x 52
DL ALU DN	150 14 W 4000 K IP44 WT	DLALU1440	4058075091450	14	1260	90	100	50.000	45.000	IK02	160 x 52
DL ALU DN	150 14 W 6500 K IP44 WT	DLALU1465	4058075091474	14	1330	95	100	50.000	45.000	IK02	160 x 52
DL ALU DN	200 25 W 3000 K IP44 WT	DLALU2530	4058075091498	25	2250	90	100	50.000	45.000	IK02	215 x 61
DL ALU DN	200 25 W 4000 K IP44 WT	DLALU2540	4058075091511	25	2370	95	100	50.000	45.000	IK02	215 x 61
DL ALU DN	200 25 W 6500 K IP44 WT	DLALU2565	4058075091535	25	2370	95	100	50.000	45.000	IK02	215 x 61
DL ALU DN	200 35 W 3000 K IP44 WT	DLALU3530	4058075091559	35	2975	85	100	50.000	45.000	IK02	215 x 61
DL ALU DN	200 35 W 4000 K IP44 WT	DLALU3540	4058075091573	35	3150	90	100	50.000	45.000	IK02	215 x 61
DL ALU DN	200 35 W 6500 K IP44 WT	DLALU3565	4058075091597	35	3150	90	100	50.000	45.000	IK02	215 x 61

- High luminous efficacy
- Energy savings up to 60% (Compared to luminaires that use CFL lamps)
- Very homogenous light
- Functional design
- Easy installation with fast connection
- External driver for extended flexibility (Compatible with selected DALI drivers)
- Converts into an emergency fitting using an Emergency Conversion Box (see page 85)
- TP(b) rated BS2782-0:2011

<sup>1</sup> The exact terms and conditions can be found at [www.ledvance.co.uk/guarantee](http://www.ledvance.co.uk/guarantee) | <sup>2</sup> t[h]: L70/B50 @ 25°C (T<sub>a</sub>) / t[h]: L80/B10 @ 25°C (T<sub>a</sub>)



## DOWNLIGHT ALU DALI



Product name	Static Code	GTIN (EAN)	W	lm	lm/W	Beam angle	L70 <sup>2</sup>	L80 <sup>2</sup>	IK	L x W x H [mm] Ø x H [mm]	Emergency icon
--------------	-------------	------------	---	----	------	------------	------------------	------------------	----	------------------------------	----------------

### DOWNLIGHT ALU DALI

NEW	DL ALU DALI DN 150 14 W 3000 K IP44 WT	DLALU1430DA	4058075202610	14	1190	85	100	50.000	45.000	IK02	160x52	✓
NEW	DL ALU DALI DN 150 14 W 4000 K IP44 WT	DLALU1440DA	4058075202634	14	1260	90	100	50.000	45.000	IK02	160x52	✓
NEW	DL ALU DALI DN 150 14 W 6500 K IP44 WT	DLALU1465DA	4058075202658	14	1330	95	100	50.000	45.000	IK02	160x52	✓
NEW	DL ALU DALI DN 200 25 W 3000 K IP44 WT	DLALU2530DA	4058075091610	25	2250	90	100	50.000	45.000	IK02	215x61	✓
NEW	DL ALU DALI DN 200 25 W 4000 K IP44 WT	DLALU2540DA	4058075091634	25	2370	95	100	50.000	45.000	IK02	215x61	✓
NEW	DL ALU DALI DN 200 25 W 6500 K IP44 WT	DLALU2565DA	4058075091658	25	2370	95	100	50.000	45.000	IK02	215x61	✓
NEW	DL ALU DALI DN 200 35 W 3000 K IP44 WT	DLALU3530DA	4058075091672	35	2975	85	100	50.000	45.000	IK02	215x61	✓
NEW	DL ALU DALI DN 200 35 W 4000 K IP44 WT	DLALU3540DA	4058075091696	35	3150	90	100	50.000	45.000	IK02	215x61	✓
NEW	DL ALU DALI DN 200 35 W 6500 K IP44 WT	DLALU3565DA	4058075091719	35	3150	90	100	50.000	45.000	IK02	215x61	✓

- Advanced functionality due to already included DALI driver
- DALI driver with individual luminaire current set-up already installed
- High luminous efficacy
- Energy savings up to 60% (Compared to luminaires that use CFL lamps)
- Very homogenous light
- Functional design
- Converts into an emergency fitting using an Emergency Conversion Box (see page 85)
- TP(b) rated BS2782-0:2011



## DOWNLIGHT SLIM ALU



Product name	Static Code	GTIN (EAN)	W	lm	lm/W	Beam angle	L70 <sup>2</sup>	L80 <sup>2</sup>	IK	L x W x H [mm] Ø x H [mm]	Emergency icon
--------------	-------------	------------	---	----	------	------------	------------------	------------------	----	------------------------------	----------------

### DOWNLIGHT SLIM ALU

	DL SLIM ALU DN 180 17 W 3000 K WT	VDLSLM180R30	4058075063921	17	1350	80	120	50.000	30.000	IK03	192x23	
	DL SLIM ALU DN 180 17 W 4000 K WT	VDLSLM180R40	4058075063945	17	1400	80	120	50.000	30.000	IK03	192x23	
	DL SLIM ALU DN 205 22 W 3000 K WT	VDLSLM205R30	4058075064003	22	1850	85	120	50.000	30.000	IK03	225x23	
	DL SLIM ALU DN 205 22 W 4000 K WT	VDLSLM205R40	4058075064027	22	1920	90	120	50.000	30.000	IK03	225x23	

- Very slim housing
- Low installation depth
- High luminous efficacy
- Energy savings up to 60% (Compared to luminaires that use CFL lamps)
- Very homogenous light
- Functional design
- Converts into an emergency fitting using an Emergency Conversion Box (see page 85)
- TP(b) rated BS2782-0:2011

<sup>1</sup> The exact terms and conditions can be found at [www.ledvance.co.uk/guarantee](http://www.ledvance.co.uk/guarantee) | <sup>2</sup> t[h]: L70/B50 @ 25°C (T<sub>a</sub>) / t[h]: L80/B10 @ 25°C (T<sub>a</sub>)



## DOWNLIGHT ALU EMERGENCY

IP20  
IP44



LEDVANCE  
3  
year  
guarantee

Product name	Static Code	GTIN (EAN)	W	lm	lm/W		L70 <sup>2</sup>	L80 <sup>2</sup>	IK	L x W x H [mm] Ø x H [mm]
--------------	-------------	------------	---	----	------	--	------------------	------------------	----	------------------------------

### DOWNLIGHT ALU EMERGENCY

NEW	DL ALU EM DN150 14 W 3000 K AT 3H WT	DLALU1430EM	4058075204201	14	1190	85	100	50.000	45.000	IK02	160x52
NEW	DL ALU EM DN150 14 W 4000 K AT 3H WT	DLALU1440EM	4058075204225	14	1260	90	100	50.000	45.000	IK02	160x52
NEW	DL ALU EM DN150 14 W 6500 K AT 3H WT	DLALU1465EM	4058075204249	14	1330	95	100	50.000	45.000	IK02	160x52
NEW	DL ALU EM DN200 25 W 3000 K AT 3H WT	DLALU2530EM	4058075204263	25	2250	90	100	50.000	45.000	IK02	215x61
NEW	DL ALU EM DN200 25 W 4000 K AT 3H WT	DLALU2540EM	4058075204287	25	2370	95	100	50.000	45.000	IK02	215x61
NEW	DL ALU EM DN200 25 W 6500 K AT 3H WT	DLALU2565EM	4058075204300	25	2370	95	100	50.000	45.000	IK02	215x61
NEW	DL ALU EM DN200 35 W 3000 K AT 3H WT	DLALU3530EM	4058075204324	35	2975	85	100	50.000	45.000	IK02	215x61
NEW	DL ALU EM DN200 35 W 4000 K AT 3H WT	DLALU3540EM	4058075204348	35	3150	90	100	50.000	45.000	IK02	215x61
NEW	DL ALU EM DN200 35 W 6500 K AT 3H WT	DLALU3565EM	4058075204362	35	3150	90	100	50.000	45.000	IK02	215x61

- Seamless integration of luminaires with emergency lighting function into general lighting
- Easy wiring thanks to included prewired driver and battery for Emergency lighting function
- Simple testing of luminaires with emergency lighting function thanks to integrated automatic test function
- Convenient visualization of results of automatic test with an included control LED
- Operation of integrated emergency lighting function with long life LiFePO4 battery with 3h battery discharge time
- High luminous efficacy in normal operation
- TP(b) rated BS2782-0:2011

<sup>1</sup> The exact terms and conditions can be found at [www.ledvance.co.uk/guarantee](http://www.ledvance.co.uk/guarantee) | <sup>2</sup> t[h]: L70/B50 @ 25°C (T<sub>a</sub>) / t[h]: L80/B10 @ 25°C (T<sub>a</sub>)

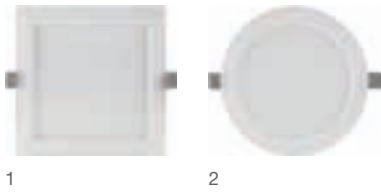

## DOWNLIGHT SLIM SQUARE AND ROUND



LEDVANCE  
**3** year  
guarantee

Product name	Static Code	GTIN (EAN)	W	lm	lm/W		L70 <sup>2</sup>	L80 <sup>2</sup>	IK	L x W x H [mm] Ø x H [mm]	
--------------	-------------	------------	---	----	------	--	------------------	------------------	----	------------------------------	--

DOWNLIGHT SLIM SQUARE											
DL SLIM SQ 105 6 W 3000 K WT	DLSLM105S30	4058075079212	6	420	70	120	30.000	20.000	IK03	118x118x30	1
DL SLIM SQ 105 6 W 4000 K WT	DLSLM105S40	4058075079236	6	430	70	120	30.000	20.000	IK03	118x118x30	1
DL SLIM SQ 105 6 W 6500 K WT	DLSLM105S65	4058075079250	6	430	70	120	30.000	20.000	IK03	118x118x30	1
DL SLIM SQ 155 12 W 3000 K WT	DLSLM155S30	4058075079274	12	1020	85	120	30.000	20.000	IK03	169x169x30	1
DL SLIM SQ 155 12 W 4000 K WT	DLSLM155S40	4058075079298	12	1020	85	120	30.000	20.000	IK03	169x169x30	1
DL SLIM SQ 155 12 W 6500 K WT	DLSLM155S65	4058075079311	12	1020	85	120	30.000	20.000	IK03	169x169x30	1
DL SLIM SQ 210 18 W 3000 K WT	DLSLM210S30	4058075079335	18	1530	85	120	30.000	20.000	IK03	225x225x30	1
DL SLIM SQ 210 18 W 4000 K WT	DLSLM210S40	4058075079359	18	1530	85	120	30.000	20.000	IK03	225x225x30	1
DL SLIM SQ 210 18 W 6500 K WT	DLSLM210S65	4058075079373	18	1530	85	120	30.000	20.000	IK03	225x225x30	1
DOWNLIGHT SLIM ROUND											
DL SLIM DN 105 6 W 3000 K WT	DLSLM105R30	4058075078970	6	420	70	120	30.000	20.000	IK03	118x30	2
DL SLIM DN 105 6 W 4000 K WT	DLSLM105R40	4058075078994	6	430	70	120	30.000	20.000	IK03	118x30	2
DL SLIM DN 105 6 W 6500 K WT	DLSLM105R65	4058075079014	6	430	70	120	30.000	20.000	IK03	118x30	2
DL SLIM DN 155 12 W 3000 K WT	DLSLM155R30	4058075079038	12	1020	85	120	30.000	20.000	IK03	169x30	2
DL SLIM DN 155 12 W 4000 K WT	DLSLM155R40	4058075079052	12	1020	85	120	30.000	20.000	IK03	169x30	2
DL SLIM DN 155 12 W 6500 K WT	DLSLM155R65	4058075079076	12	1020	85	120	30.000	20.000	IK03	169x30	2
DL SLIM DN 210 18 W 3000 K WT	DLSLM210R30	4058075079090	18	1530	85	120	30.000	20.000	IK03	225x30	2
DL SLIM DN 210 18 W 4000 K WT	DLSLM210R40	4058075079113	18	1530	85	120	30.000	20.000	IK03	225x30	2
DL SLIM DN 210 18 W 6500 K WT	DLSLM210R65	4058075079137	18	1530	85	120	30.000	20.000	IK03	225x30	2

- Very slim housing
- Low installation depth
- High luminous efficacy
- Energy savings up to 60% (Compared to luminaires that use CFL lamps)
- Very homogenous light
- Functional design

<sup>1</sup> The exact terms and conditions can be found at [www.ledvance.co.uk/guarantee](http://www.ledvance.co.uk/guarantee) | <sup>2</sup> t[h]: L70/B50 @ 25°C (T<sub>a</sub>) / t[h]: L80/B10 @ 25°C (T<sub>a</sub>)



1



2

## DOWNLIGHT SLIM SQUARE AND ROUND FRAME

LEDVANCE  
2 year  
guarantee

Product name	Static Code	GTIN (EAN)	L x W x H [mm] Ø x H [mm]	Light No.
<b>DOWNLIGHT SLIM SQUARE FRAME</b>				
DL SLIM FRAME SQ 105 WT	FRAME105S	4058075079397	121 x 121 x 54	1
DL SLIM FRAME SQ 155 WT	FRAME155S	4058075079410	170 x 170 x 38	1
DL SLIM FRAME SQ 210 WT	FRAME210S	4058075079434	225 x 225 x 38	1
<b>DOWNLIGHT SLIM ROUND FRAME</b>				
DL SLIM FRAME DN 105 WT	FRAME105R	4058075079151	121 x 54	2
DL SLIM FRAME DN 155 WT	FRAME155R	4058075079175	170 x 38	2
DL SLIM FRAME DN 210 WT	FRAME210R	4058075079199	225 x 38	2

- Cable entry on the side for electrical connection with low profile
- Easy installation thanks to included drilling template

<sup>1</sup> The exact terms and conditions can be found at [www.ledvance.co.uk/guarantee](http://www.ledvance.co.uk/guarantee)

# SPOTLIGHTS

## IMPRESSIVE ALL ROUND: OUR SPOTLIGHTS

**A few simple steps:**

Spotlights from LEDVANCE are quick and easy to install.



**In good shape:** The spotlight housings are impressive for their durable high quality finish.



## SPOT VARIO



Product name Static Code GTIN (EAN) W lm lm/W  $\theta$  L70<sup>2</sup> L80<sup>2</sup> IK L x W x H [mm]  
 Ø x H [mm]

### SPOT VARIO

NEW	SPOT VARIO DN 170 35 W 3000 K 24DEG WT	SV17030WH	4058075104020	35	3350	95	24	50.000	45.000	IK03	180x129
NEW	SPOT VARIO DN 170 35 W 4000 K 24DEG WT	SV17040WH	4058075104044	35	3550	100	24	50.000	45.000	IK03	180x129

- Low flicker light thanks to special electronic control gear
- High luminous efficacy
- Die-cast aluminum housing for improved heat dissipation
- Easy replacement of external driver thanks to plug with bayonet lock
- Design matches the LEDVANCE Spot, Down and Tracklight luminaire family
- Shallow mounting depth



1



2



3

## SPOT MULTI



Product name Static Code GTIN (EAN) W lm lm/W  $\theta$  L70<sup>2</sup> L80<sup>2</sup> IK L x W x H [mm]  
 Ø x H [mm] No.

### SPOT MULTI 1x30W

NEW	SPOT MULTI 1 x 30W 3000K FL WT/BK	SM130	4058075113923	30	2700	90	38	50.000	45.000	IK03	173x173x135	1
NEW	SPOT MULTI 1 x 30W 4000K FL WT/BK	SM140	4058075113947	30	2700	90	38	50.000	45.000	IK03	173x173x135	1

### SPOT MULTI 2x30W

NEW	SPOT MULTI 2 x 30W 3000K FL WT/BK	SM230	4058075113961	2*30	2*2700	90	38	50.000	45.000	IK03	330x173x135	2
NEW	SPOT MULTI 2 x 30W 4000K FL WT/BK	SM240	4058075113985	2*30	2*2700	90	38	50.000	45.000	IK03	330x173x135	2

### SPOT MULTI 3x30W

NEW	SPOT MULTI 3 x 30W 3000K FL WT/BK	SM330	4058075114005	3*30	3*2700	90	38	50.000	45.000	IK03	487x173x135	3
NEW	SPOT MULTI 3 x 30W 4000K FL WT/BK	SM340	4058075114029	3*30	3*2700	90	38	50.000	45.000	IK03	487x173x135	3

- Low flicker light thanks to special electronic control gear
- High luminous efficacy
- Covering against other ceiling installations thanks to closed sheet steel housing
- Easy replacement of external driver thanks to plug with bayonet lock
- Functional and minimalistic design

<sup>1</sup> The exact terms and conditions can be found at [www.ledvance.co.uk/guarantee](http://www.ledvance.co.uk/guarantee) | <sup>2</sup> t[h]: L70/B50 @ 25°C (T<sub>a</sub>) / t[h]: L80/B10 @ 25°C (T<sub>a</sub>)



## SPOT SQUARE DARKLIGHT ADJUST



Product name	Static Code	GTIN (EAN)	W	lm	lm/W	$\theta$	L70 <sup>2</sup>	L80 <sup>2</sup>	IK	L x W x H [mm] Ø x H [mm]
--------------	-------------	------------	---	----	------	----------	------------------	------------------	----	------------------------------

### SPOT SQUARE DARKLIGHT ADJUST

NEW	SPOT SQUARE DK ADJ 8 W 3000 K WT	SSA30W	4058075114043	8	650	90	36	50.000	45.000	IK03	90 x 90 x 72
NEW	SPOT SQUARE DK ADJ 8 W 3000 K BK	SSA30B	4058075114067	8	650	90	36	50.000	45.000	IK03	90 x 90 x 72

- Cut off angle for comfortable indoor lighting
- High luminous efficacy
- Die-cast aluminum housing for improved heat dissipation
- Energy savings of up to 90% compared to halogen lamp spotlights
- External driver for extended flexibility (Compatible with selected DALI drivers)
- Easy replacement of external driver thanks to plug with bayonet lock



## SPOT ADJUST



Product name	Static Code	GTIN (EAN)	W	lm	lm/W	$\theta$	L70 <sup>2</sup>	L80 <sup>2</sup>	IK	L x W x H [mm] Ø x H [mm]
--------------	-------------	------------	---	----	------	----------	------------------	------------------	----	------------------------------

### SPOT ADJUST

	SPOT ADJUST 4.50 W 3000 K WT	S35R30	4058075126886	5	360	80	36	50.000	40.000	IK06	80 x 36
	SPOT ADJUST 6.50 W 3000 K WT	S50R30	4058075126909	7	550	85	36	50.000	40.000	IK06	80 x 36
	SPOT ADJUST 8 W 3000 K WT	S75R30	4058075126848	8	660	85	36	50.000	40.000	IK06	90 x 47
	SPOT ADJUST 8 W 4000 K WT	S75R40	4058075126862	8	720	90	36	50.000	40.000	IK06	90 x 47

- High luminous efficacy
- Design matches the LEDVANCE DOWNLIGHT luminaire family
- Energy savings of up to 90% compared to halogen lamp spotlights
- Functional and minimalistic design
- Easy and quick installation
- External driver for extended flexibility (Compatible with selected DALI drivers)

<sup>1</sup> The exact terms and conditions can be found at [www.ledvance.co.uk/guarantee](http://www.ledvance.co.uk/guarantee) | <sup>2</sup> t[h]: L70/B50 @ 25°C (T<sub>a</sub>) / t[h]: L80/B10 @ 25°C (T<sub>a</sub>)





## SPOT ADJUST DALI



Product name	Static Code	GTIN (EAN)	W	lm	lm/W	$\beta$	L70 <sup>2</sup>	L80 <sup>2</sup>	IK	L x W x H [mm] Ø x H [mm]	
--------------	-------------	------------	---	----	------	---------	------------------	------------------	----	------------------------------	--

### SPOT ADJUST DALI

SPOT ADJUST DALI 8 W 3000 K IP20 WT	SDA75R30	4058075219946	8	660	85	36	50.000	40.000	IK06	90x47	✓
SPOT ADJUST DALI 8 W 4000 K IP20 WT	SDA75R40	4058075219922	8	720	90	36	50.000	40.000	IK06	90x47	✓

- Advanced functionality due to already included DALI driver
- DALI driver with individual luminaire current set-up already installed
- High luminous efficacy
- Design matches the LEDVANCE DOWNLIGHT luminaire family
- Energy savings of up to 90% compared to halogen lamp spotlights
- Functional and minimalistic design



## SPOT FIREPROOF DIM



Product name	Static Code	GTIN (EAN)	W	lm	lm/W	$\beta$	L70 <sup>2</sup>	L80 <sup>2</sup>	IK	L x W x H [mm] Ø x H [mm]	
--------------	-------------	------------	---	----	------	---------	------------------	------------------	----	------------------------------	--

### SPOT FIREPROOF DIM

SPOT FP FIX DIM 8 W 3000 K IP65 WT	SFPD7530W	4058075127432	8	620	75	36	50.000	40.000	IK06	81x51	✓
SPOT FP FIX DIM 8 W 4000 K IP65 WT	SFPD7540W	4058075127555	8	670	80	36	50.000	40.000	IK06	81x51	✓
SPOT FP FIX DIM 8 W 3000 K IP65 SI	SFPD7530S	4058075127371	8	620	75	36	50.000	40.000	IK06	81x51	✓
SPOT FP FIX DIM 8 W 4000 K IP65 SI	SFPD7540S	4058075127494	8	670	80	36	50.000	40.000	IK06	81x51	✓

- High luminous efficacy
- Design matches the LEDVANCE DOWNLIGHT luminaire family
- Energy savings of up to 90% compared to halogen lamp spotlights
- Functional and minimalistic design
- Easy installation with fast connection
- External driver for extended flexibility (Compatible with selected DIM drivers)

<sup>1</sup> The exact terms and conditions can be found at [www.ledvance.co.uk/guarantee](http://www.ledvance.co.uk/guarantee) | <sup>2</sup> t[h]: L70/B50 @ 25°C (T<sub>a</sub>) / t[h]: L80/B10 @ 25°C (T<sub>a</sub>)



## SPOT FIREPROOF



Product name	Static Code	GTIN (EAN)	W	lm	lm/W	$\Delta$	L70 <sup>2</sup>	L80 <sup>2</sup>	IK	L x W x H [mm] Ø x H [mm]	
<b>SPOT FIREPROOF</b>											
SPOT FP FX 7 W 3000 K IP65 WT	SFP5030	4058075127333	7	530	75	38	50.000	40.000	IK06	90 x 72	

- High luminous efficacy
- Design matches the LEDVANCE DOWNLIGHT luminaire family
- Energy savings of up to 90% compared to halogen lamp spotlights
- Functional and minimalistic design
- Easy installation with fast connection
- External driver for extended flexibility (Compatible with selected DIM drivers)



## SPOT DIM



Product name	Static Code	GTIN (EAN)	W	lm	lm/W	$\Delta$	L70 <sup>2</sup>	L80 <sup>2</sup>	IK	L x W x H [mm] Ø x H [mm]	
<b>SPOT DIM</b>											
SPOT FIX DIM 8 W 3000 K IP44 SI	SD7530S	4058075126923	8	620	75	36	50.000	40.000	IK06	81 x 51	✓
SPOT FIX DIM 8 W 3000 K IP44 WT	SD7530W	4058075127043	8	620	75	36	50.000	40.000	IK06	81 x 51	✓
SPOT FIX DIM 8 W 4000 K IP44 SI	SD7540S	4058075127067	8	670	80	36	50.000	40.000	IK06	81 x 51	✓
SPOT FIX DIM 8 W 4000 K IP44 WT	SD7540W	4058075127104	8	670	80	36	50.000	40.000	IK06	81 x 51	✓

- High luminous efficacy
- Design matches the LEDVANCE DOWNLIGHT luminaire family
- Energy savings of up to 90% compared to halogen lamp spotlights
- Functional and minimalistic design
- Easy and quick installation
- External driver for extended flexibility (Compatible with selected DALI drivers)

<sup>1</sup> The exact terms and conditions can be found at [www.ledvance.co.uk/guarantee](http://www.ledvance.co.uk/guarantee) | <sup>2</sup> t[h]: L70/B50 @ 25°C (T<sub>a</sub>) / t[h]: L80/B10 @ 25°C (T<sub>a</sub>)



## SPOT DARKLIGHT

IP44

LEDVANCE  
5 year  
guarantee

Product name	Static Code	GTIN (EAN)	W	lm	lm/W		L70 <sup>2</sup>	L80 <sup>2</sup>	IK	L x W x H [mm] Ø x H [mm]
<b>SPOT DARKLIGHT</b> SPOT DK FIX 7 W 3000 K IP44 WT	SDARK5030W	4058075127166	7	580	85	36	50.000	40.000	IK06	70x58

- Design matches the LEDVANCE DOWNLIGHT luminaire family
- Energy savings of up to 90% compared to halogen lamp spotlights
- Functional and minimalistic design
- Easy installation with fast connection
- External driver for extended flexibility (Compatible with selected DIM drivers)
- Designed for extra performance



## SPOT KIT

IP20

LEDVANCE  
3 year  
guarantee

Product name	Static Code	GTIN (EAN)	W	lm	lm/W		L70 <sup>2</sup>	IK	L x W x H [mm] Ø x H [mm]	
<b>SPOT KIT</b> SP KIT ADJ 7 W 4000 K GU10 DIM	SAKIT75D	4058075156784	7	500	70	36	25.000	IK03	89x107	✓

- Direct replacement for conventional 50 W halogen luminaires
- Energy savings of up to 90% compared to conventional recessed luminaires
- Single spot optics
- White die-cast zinc alloy ring
- Replaceable LED lamp

<sup>1</sup> The exact terms and conditions can be found at [www.ledvance.co.uk/guarantee](http://www.ledvance.co.uk/guarantee) | <sup>2</sup> t[h]: L70/B50 @ 25°C (T<sub>a</sub>) / t[h]: L80/B10 @ 25°C (T<sub>a</sub>)

# TRACKLIGHTS

## TRACKLIGHTS: REDUCED DESIGN, EXTENSIVE FUNCTIONS



### TRACKLIGHT SPOT – A TRUE ALL-ROUNDER

Ideal as a standard compact luminaire for a wide variety of applications, especially in retail outlets. Available in 3 colours, 3 sizes and with 3 interchangeable reflectors.

### TRACKLIGHT SPOT COMPACT- AESTHETIC AND FUNCTIONAL

Whether it's for a supermarket or a fashion boutique, the attractive Tracklight Spot Compact in the low-profile SCALE design blends seamlessly with any surroundings.

### TRACKLIGHT SPOT ZOOM – A FLEXIBLE SPOTLIGHT FOR UNIVERSAL USE

Excellent lighting for galleries and up-market fashion stores thanks to CRI 97, a dimmer directly on the housing and fully retractable mechanical zoom lens.



## TRACKLIGHT SPOT COMPACT



Product name

Static Code

GTIN (EAN)

L x W x H [mm]  
Ø x H [mm]

### TRACKLIGHT SPOT COMPACT

NEW	Product name	Static Code	GTIN (EAN)	W	lm	lm/w	Beam angle	L70 <sup>2</sup>	L80 <sup>2</sup>	IK	L x W x H [mm] Ø x H [mm]
	TRACKLIGHT SPOT COMPACT										
NEW	TR SP COMPACT D100 28 W 930 NFL WT	TSC2830NFLW	4058075335844	28	2280	80	25	80.000	50.000	IK03	260 x 33x160
NEW	TR SP COMPACT D100 28 W 930 FL WT	TSC2830FLW	4058075335868	28	2200	80	36	80.000	50.000	IK03	260 x 33x160
NEW	TR SP COMPACT D100 28 W 940 NFL WT	TSC2840NFLW	4058075335882	28	2380	85	25	80.000	50.000	IK03	260 x 33x160
NEW	TR SP COMPACT D100 28 W 940 FL WT	TSC2840FLW	4058075335905	28	2300	80	36	80.000	50.000	IK03	260 x 33x160
NEW	TR SP COMPACT D100 28 W 930 NFL BK	TSC2830NFLB	4058075335929	28	2280	80	25	80.000	50.000	IK03	260 x 33x160
NEW	TR SP COMPACT D100 28 W 930 FL BK	TSC2830FLB	4058075335943	28	2200	80	36	80.000	50.000	IK03	260 x 33x160
NEW	TR SP COMPACT D100 28 W 940 NFL BK	TSC2840NFLB	4058075335967	28	2380	85	25	80.000	50.000	IK03	260 x 33x160
NEW	TR SP COMPACT D100 28 W 940 FL BK	TSC2840FLB	4058075335981	28	2300	80	36	80.000	50.000	IK03	260 x 33x160
NEW	TR SP COMPACT D100 28 W 940 NFL GY	TSC2830NFLG	4058075336001	28	2280	80	25	80.000	50.000	IK03	260 x 33x160
NEW	TR SP COMPACT D100 28 W 930 FL GY	TSC2830FLG	4058075336025	28	2200	80	36	80.000	50.000	IK03	260 x 33x160
NEW	TR SP COMPACT D100 28 W 940 NFL GY	TSC2840NFLG	4058075336049	28	2380	85	25	80.000	50.000	IK03	260 x 33x160
NEW	TR SP COMPACT D100 28 W 940 FL GY	TSC2840FLG	4058075336063	28	2300	80	36	80.000	50.000	IK03	260 x 33x160

- Timeless design suitable for high-quality interior
- Included 3-phase adapter compatible with common tracks (NORLUX, GLOBAL, NUCO, NORDIC)
- No distraction of attention from the illuminated objects thanks to reduced design
- Low flicker light thanks to special electronic control gear



## TRACKLIGHT SPOT ZOOM DIM



Product name

Static Code

GTIN (EAN)

L x W x H [mm]  
Ø x H [mm]

### TRACKLIGHT SPOT ZOOM DIM

NEW	Product name	Static Code	GTIN (EAN)	W	lm	lm/w	Beam angle	L70 <sup>2</sup>	L80 <sup>2</sup>	IK	L x W x H [mm] Ø x H [mm]	
	TRACKLIGHT SPOT ZOOM DIM											
NEW	TR SP ZOOM DIM D85 25 W 3000 K 97R WT	TSZ25D30W	4058075335769	25	1500	60	15 ... 55	50.000	35.000	IK03	85 x 265	✓
NEW	TR SP ZOOM DIM D85 25 W 4000 K 97R WT	TSZ25D40W	4058075335783	25	1500	60	15 ... 55	50.000	35.000	IK03	85 x 265	✓
NEW	TR SP ZOOM DIM D85 25 W 3000 K 97R BK	TSZ25D30B	4058075335806	25	1500	60	15 ... 55	50.000	35.000	IK03	85 x 265	✓
NEW	TR SP ZOOM DIM D85 25 W 4000 K 97R BK	TSZ25D40B	4058075335820	25	1500	60	15 ... 55	50.000	35.000	IK03	85 x 265	✓

- Dimmable 3-phase tracklight spot with mechanical zoom lens
- Included 3-phase adapter compatible with common tracks (STAFF, NORLUX, GLOBAL, NUCO, NORDIC)
- No distraction of attention from the illuminated objects thanks to reduced design
- Low flicker light thanks to special electronic control gear

<sup>1</sup> The exact terms and conditions can be found at [www.ledvance.co.uk/guarantee](http://www.ledvance.co.uk/guarantee) | <sup>2</sup> t[h]: L70/B50 @ 25°C (T<sub>a</sub>) / t[h]: L80/B10 @ 25°C (T<sub>a</sub>)



## TRACKLIGHT SPOT



Product name	Static Code	GTIN (EAN)	W	lm	lm/W	°	L70 <sup>2</sup>	L80 <sup>2</sup>	IK	L x W x H [mm]	Ø x H [mm]	Light No.
--------------	-------------	------------	---	----	------	---	------------------	------------------	----	----------------	------------	-----------

### TRACKLIGHT SPOT D75 25W

NEW	TRACK SP D75 25 W 3000 K 90RA NFL WT	TL2530WH	4058075113442	25	1750	70	24	50.000	45.000	IK03	75x255	1
NEW	TRACK SP D75 25 W 4000 K 90RA NFL WT	TL2540WH	4058075113466	25	1900	75	24	50.000	45.000	IK03	75x255	1
NEW	TRACK SP D75 25 W 3000 K 90RA NFL BK	TL2530BL	4058075113565	25	1750	75	24	50.000	45.000	IK03	75x255	1
NEW	TRACK SP D75 25 W 4000 K 90RA NFL BK	TL2540BL	4058075113589	25	1900	80	24	50.000	45.000	IK03	75x255	1
NEW	TRACK SP D75 25 W 3000 K 90RA NFL GY	TL2530GR	4058075113688	25	1750	75	24	50.000	45.000	IK03	75x255	1
NEW	TRACK SP D75 25 W 4000 K 90RA NFL GY	TL2540GR	4058075113701	25	1900	75	24	50.000	45.000	IK03	75x255	1

### TRACKLIGHT SPOT D85 35W

NEW	TRACK SP D85 35 W 3000 K 90RA NFL WT	TL3530WH	4058075113480	35	2660	70	24	50.000	45.000	IK03	85x267	2
NEW	TRACK SP D85 35 W 4000 K 90RA NFL WT	TL3540WH	4058075113503	35	2800	75	24	50.000	45.000	IK03	85x267	2
NEW	TRACK SP D85 35 W 3000 K 90RA NFL BK	TL3530BL	4058075113602	35	2660	75	24	50.000	45.000	IK03	85x267	2
NEW	TRACK SP D85 35 W 4000 K 90RA NFL BK	TL3540BL	4058075113626	35	2800	80	24	50.000	45.000	IK03	85x267	2
NEW	TRACK SP D85 35 W 3000 K 90RA NFL GY	TL3530GR	4058075113725	35	2660	75	24	50.000	45.000	IK03	85x267	2
NEW	TRACK SP D85 35 W 4000 K 90RA NFL GY	TL3540GR	4058075113749	35	2800	75	24	50.000	45.000	IK03	85x267	2

### TRACKLIGHT SPOT D95 55W

NEW	TRACK SP D95 55 W 3000 K 90RA NFL WT	TL5530WH	4058075113527	55	4000	70	24	50.000	45.000	IK03	95x297	3
NEW	TRACK SP D95 55 W 4000 K 90RA NFL WT	TL5540WH	4058075113541	55	4200	75	24	50.000	45.000	IK03	95x297	3
NEW	TRACK SP D95 55 W 3000 K 90RA NFL BK	TL5530BL	4058075113640	55	4000	75	24	50.000	45.000	IK03	95x297	3
NEW	TRACK SP D95 55 W 4000 K 90RA NFL BK	TL5540BL	4058075113664	55	4200	80	24	50.000	45.000	IK03	95x297	3
NEW	TRACK SP D95 55 W 3000 K 90RA NFL GY	TL5530GR	4058075113763	55	4000	75	24	50.000	45.000	IK03	95x297	3
NEW	TRACK SP D95 55 W 4000 K 90RA NFL GY	TL5540GR	4058075113787	55	4200	75	24	50.000	45.000	IK03	95x297	3

- Included 3-phase adapter compatible with common tracks (STAFF, NORLUX, GLOBAL, NUCO, NORDIC)
- Deep reflector and black antiglare ring for minimized glare (UGR<16)
- Reflector easily replaceable thanks to bayonet catch and rubber suction pad
- No distraction of attention from the illuminated objects thanks to reduced design
- Low flicker light thanks to special electronic control gear

<sup>1</sup> The exact terms and conditions can be found at [www.ledvance.co.uk/guarantee](http://www.ledvance.co.uk/guarantee) | <sup>2</sup> t[h]: L70/B50 @ 25°C (T<sub>a</sub>) / t[h]: L80/B10 @ 25°C (T<sub>a</sub>)



## TRACKLIGHT SPOT REFLECTOR

LEDVANCE  
**2**  
year  
guarantee

Product name	Static Code	GTIN (EAN)		L x W x H [mm] Ø x H [mm]
--------------	-------------	------------	---	------------------------------

TRACKLIGHT SPOT REFLECTOR				
NEW	TRACK SP REFLECTOR D75 SP	TREFD7515	4058075113800	15 63x53
NEW	TRACK SP REFLECTOR D75 FL	TREFD7538	4058075113824	38 63x53
NEW	TRACK SP REFLECTOR D85 SP	TREFD8515	4058075113848	15 75x63
NEW	TRACK SP REFLECTOR D85 FL	TREFD8538	4058075113862	38 75x63
NEW	TRACK SP REFLECTOR D95 SP	TREFD9515	4058075113886	15 82x69
NEW	TRACK SP REFLECTOR D95 FL	TREFD9538	4058075113909	38 82x69

- Reflector easily replaceable thanks to bayonet catch and rubber suction pad
- Clear cover protects the reflector against dust and contact
- High optical efficacy

<sup>1</sup> The exact terms and conditions can be found at [www.ledvance.co.uk/guarantee](http://www.ledvance.co.uk/guarantee)

# WALL AND CEILING LUMINAIRES

## LEDVANCE SURFACE COMPACT IK10: ROBUST, RUGGED AND VANDAL-PROOF



### TOP DEFENCE

Thanks to its robust construction and IK10 protection, it offers particularly high impact strength and is therefore ideally protected against vandalism.



### NOT A SCREW LOOSE

The torx screws prevent the luminaire being removed with a conventional screwdriver.





## SURFACE COMPACT IK10



Product name	Static Code	GTIN (EAN)	W	lm	lm/W	$\theta$	L70 <sup>2</sup>	L80 <sup>2</sup>	IK	L x W x H [mm] Ø x H [mm]
--------------	-------------	------------	---	----	------	----------	------------------	------------------	----	------------------------------

### SURFACE COMPACT IK10

SF COMPACT IK10 300 24 W 3000 K IP65 WT	SCOM2430	4058075062207	24	1800	75	120	50.000	30.000	IK10	300x61
SF COMPACT IK10 300 24 W 4000 K IP65 WT	SCOM2440	4058075062221	24	1920	80	120	50.000	30.000	IK10	300x61

- Slim profile
- Resistance against vandalism
- High luminous efficacy
- Very homogenous light
- LED protected for safe installation



1



2



3

## SURFACE CIRCULAR SENSOR



Product name	Static Code	GTIN (EAN)	W	lm	lm/W	$\theta$	L70 <sup>2</sup>	L80 <sup>2</sup>	IK	L x W x H [mm] Ø x H [mm]	No.
--------------	-------------	------------	---	----	------	----------	------------------	------------------	----	------------------------------	-----

### SURFACE CIRCULAR 250 SENSOR

<b>NEW</b> SF CIRCULAR 250 S 13 W 3000 K IP44 WT	SC25030S	4058075314894	13	920	70	120	30.000	30.000	IK03	250x91	1
<b>NEW</b> SF CIRCULAR 250 S 13 W 4000 K IP44 WT	SC25040S	4058075314917	13	960	75	120	30.000	30.000	IK03	250x91	1

### SURFACE CIRCULAR 350 SENSOR

<b>NEW</b> SF CIRCULAR 350 S 18 W 3000 K IP44 WT	SC35030S	4058075314931	18	1440	80	120	30.000	30.000	IK03	350x115	2
<b>NEW</b> SF CIRCULAR 350 S 18 W 4000 K IP44 WT	SC35040S	4058075314955	18	1440	80	120	30.000	30.000	IK03	350x115	2

### SURFACE CIRCULAR 400 SENSOR

<b>NEW</b> SF CIRCULAR 400 S 24 W 3000 K IP44 WT	SC40030S	4058075314979	24	1920	80	120	30.000	30.000	IK03	400x120	3
<b>NEW</b> SF CIRCULAR 400 S 24 W 4000 K IP44 WT	SC40040S	4058075314993	24	1920	80	120	30.000	30.000	IK03	400x120	3

- Easy adjustment of sensor range, daylight detection and hold time
- High luminous efficacy
- Energy savings of up to 55% compared to luminaires that use CFL
- Easy and quick installation
- Very homogenous light
- Clear cover protects the reflector against dust and contact

<sup>1</sup> The exact terms and conditions can be found at [www.ledvance.co.uk/guarantee](http://www.ledvance.co.uk/guarantee) | <sup>2</sup> t[h]: L70/B50 @ 25°C (T<sub>a</sub>) / t[h]: L80/B10 @ 25°C (T<sub>a</sub>)



## SURFACE CIRCULAR



Product name	Static Code	GTIN (EAN)	W	lm	lm/W	$\Delta$	L70 <sup>2</sup>	L80 <sup>2</sup>	IK	L x W x H [mm] Ø x H [mm]
--------------	-------------	------------	---	----	------	----------	------------------	------------------	----	------------------------------

## SURFACE CIRCULAR 250

NEW	SF CIRCULAR 250 13 W 3000 K IP44 WT	SC25030	4058075110120	13	920	70	120	30.000	30.000	IK03	250 x 91
NEW	SF CIRCULAR 250 13 W 4000 K IP44 WT	SC25040	4058075110144	13	960	75	120	30.000	30.000	IK03	250 x 91

## SURFACE CIRCULAR 350

	SF CIRCULAR 350 18 W 3000 K IP44 WT	SC35030	4058075080010	18	1440	80	120	30.000	30.000	IK03	350 x 115
	SF CIRCULAR 350 18 W 4000 K IP44 WT	SC35040	4058075080034	18	1440	80	120	30.000	30.000	IK03	350 x 115

## SURFACE CIRCULAR 400

	SF CIRCULAR 400 24 W 3000 K IP44 WT	SC40030	4058075080058	24	1920	80	120	30.000	30.000	IK03	400 x 120
	SF CIRCULAR 400 24 W 4000 K IP44 WT	SC40040	4058075080072	24	1920	80	120	30.000	30.000	IK03	400 x 120

- High luminous efficacy
- Energy savings of up to 55% compared to luminaires that use CFL
- Easy and quick installation
- Very homogenous light
- Clear cover protects the reflector against dust and contact



## SURFACE CIRCULAR COVER



Product name	Static Code	GTIN (EAN)	$\Delta$	L x W x H [mm] Ø x H [mm]
--------------	-------------	------------	----------	------------------------------

## SURFACE CIRCULAR COVER

NEW	SF CIRCULAR 250 Cover	SC250COV	4058075156722	120	250 x 80
NEW	SF CIRCULAR 350 Cover	SC350COV	4058075156807	120	350 x 104
NEW	SF CIRCULAR 400 Cover	SC400COV	4058075156821	120	400 x 112

- Easy replacement of the cover without changing the luminaire

<sup>1</sup> The exact terms and conditions can be found at [www.ledvance.co.uk/guarantee](http://www.ledvance.co.uk/guarantee) | <sup>2</sup> t[h]: L70/B50 @ 25°C (T<sub>a</sub>) / t[h]: L80/B10 @ 25°C (T<sub>a</sub>)



# PANEL LUMINAIRES

## ALL THE BENEFITS AT A GLANCE: PANEL LUMINAIRES FROM LEDVANCE

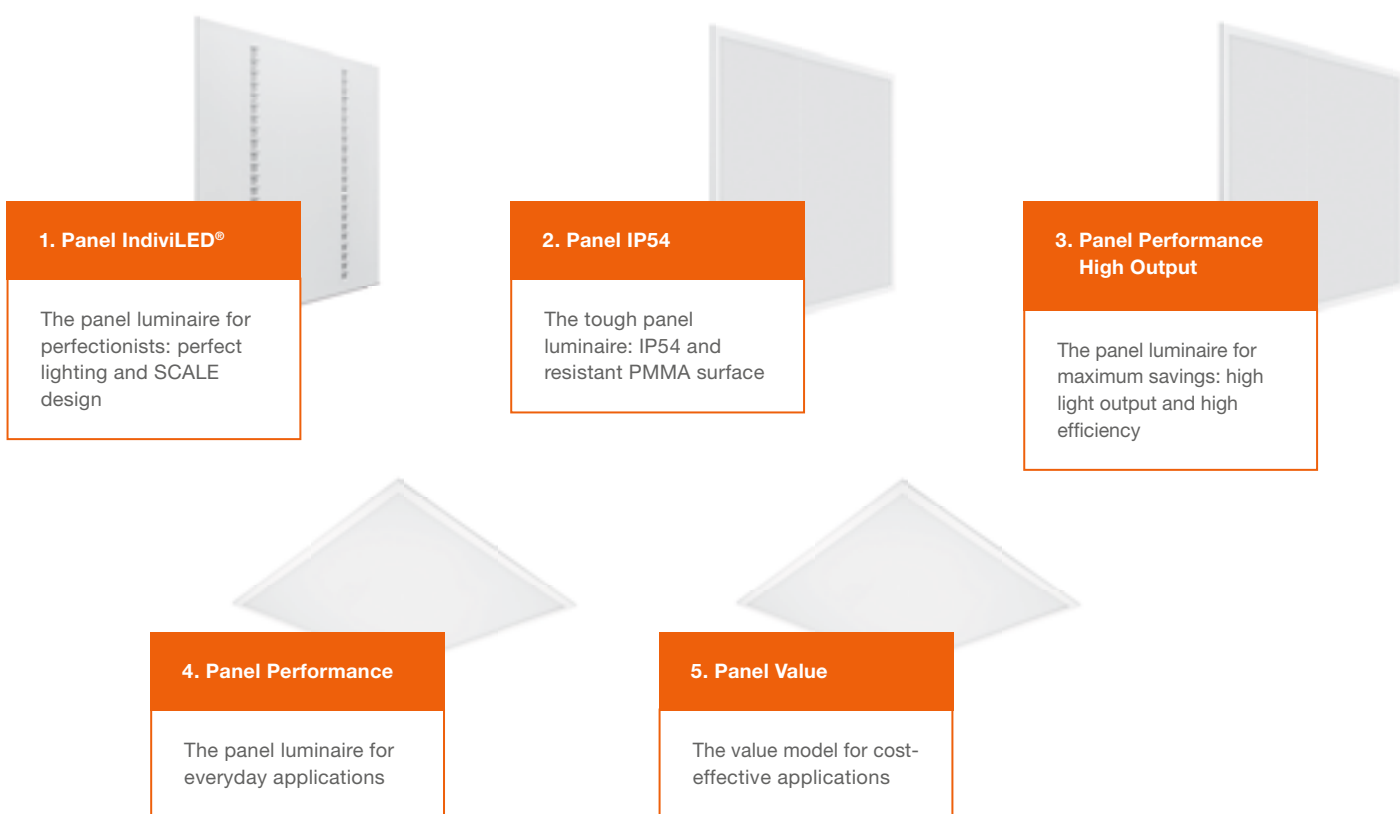

### THE MOST IMPORTANT SPECIFICATIONS AT A GLANCE

		lm/W (max)	lm (max)	SDCM	UGR	L80/B10 and L70/B50, life (max) <sup>1</sup>	Guaran-tee <sup>2</sup>	IP	IK	Other properties
<b>1</b>	Panel IndiviLED®	120	4,000	3	<16	L80/B10, 60,000 h	5 years	IP40	IK08	SCALE with IndiviLED® optics
<b>2</b>	Panel IP54	120	4,320	3	<22	L80/B10, 60,000 h	5 years	IP54	IK03	PMMA surface
<b>3</b>	Panel Performance High Output	120	4,320	3	<22 <19	L80/B10, 60,000 h	5 years	IP20	IK03	Safety cable for luminaire included
<b>4</b>	Panel Performance	110	4,000	5	<22 <19	L80/B10, 60,000 h	5 years	IP20	IK03	3-pin terminal included
<b>5</b>	Panel Value	90	3,600	5	<22 <19	L70/B50, 50,000 h	3 years	IP20	IK03	Standard

<sup>1</sup> t[h]: L80/B10 @ 25 °C (T<sub>a</sub>) and t[h]: L70/B50 @ 25 °C (T<sub>a</sub>) | <sup>2</sup> Refer to [www.ledvance.co.uk/guarantee](http://www.ledvance.co.uk/guarantee)



## PANEL IndiviLED



Product name	Static Code	GTIN (EAN)	W	lm	lm/W	$\Delta$	L70 <sup>2</sup>	L80 <sup>2</sup>	IK	L x W x H [mm] Ø x H [mm]
--------------	-------------	------------	---	----	------	----------	------------------	------------------	----	------------------------------

### PANEL IndiviLED® 600

NEW	PANEL INDV 600 33 W 3000 K	PIND60030	4058075201132	33	3800	115	70	80.000	60.000	IK08	595x595x13
NEW	PANEL INDV 600 33 W 4000 K	PIND60040	4058075201156	33	4000	120	70	80.000	60.000	IK08	595x595x13

- Homogenous light distribution and reduced glare thanks to the IndiviLED optics
- Energy savings of up to 50% (Compared to luminaires that use fluorescent lamps)
- Robust structure with IK08
- Low flicker light thanks to special electronic control gear
- Further variants with DALI ECG or emergency lighting function according to IEC 60598-2-22 additionally available
- TP(a) rated BS2782-0:2011
- Converts into an emergency fitting using an Emergency Conversion Box (see page 85)



## PANEL IndiviLED® DALI



Product name	Static Code	GTIN (EAN)	W	lm	lm/W	$\Delta$	L70 <sup>2</sup>	L80 <sup>2</sup>	IK	L x W x H [mm] Ø x H [mm]	
--------------	-------------	------------	---	----	------	----------	------------------	------------------	----	------------------------------	--

### PANEL IndiviLED® DALI 600

NEW	PANEL INDV DALI 600 33 W 3000 K	PIND60030DA	4058075201217	33	3800	115	70	80.000	60.000	IK08	595x595x13	✓
NEW	PANEL INDV DALI 600 33 W 4000 K	PIND60040DA	4058075201231	33	4000	120	70	80.000	60.000	IK08	595x595x13	✓

- High compatibility thanks to DALI-2 certification
- Homogenous light distribution and reduced glare thanks to the IndiviLED optics
- Energy savings of up to 50% (Compared to luminaires that use fluorescent lamps)
- Robust structure with IK08
- Low flicker light thanks to special electronic control gear
- Further variants with emergency lighting function according to IEC 60598-2-22 additionally available
- TP(a) rated BS2782-0:2011
- Converts into emergency fitting using Emergency Conversion Box (see page 85)

<sup>1</sup> The exact terms and conditions can be found at [www.ledvance.co.uk/guarantee](http://www.ledvance.co.uk/guarantee) | <sup>2</sup> t[h]: L70/B50 @ 25°C (T<sub>a</sub>) / t[h]: L80/B10 @ 25°C (T<sub>a</sub>)



## PANEL IndiviLED® EMERGENCY

IP40  LEDVANCE <sup>1</sup>  
3 year guarantee

Product name	Static Code	GTIN (EAN)	W	lm	lm/w		L70 <sup>2</sup>	L80 <sup>2</sup>	IK	L x W x H [mm] Ø x H [mm]
--------------	-------------	------------	---	----	------	---	------------------	------------------	----	------------------------------

### PANEL IndiviLED® EMERGENCY 600

NEW	PANEL INDV EM 600 33 W 3000 K	PIND60030EM	4058075201293	33	3800	115	70	80.000	60.000	IK08	595x595x13
NEW	PANEL INDV EM 600 33 W 4000 K	PIND60040EM	4058075201316	33	4000	120	70	80.000	60.000	IK08	595x595x13

- Homogenous light distribution and reduced glare thanks to the IndiviLED optics
- Seamless integration of luminaires with emergency lighting function into general lighting
- Easy wiring thanks to included prewired driver and battery for Emergency lighting function
- Simple testing of luminaires with emergency lighting function thanks to integrated automatic test function
- Convenient visualization of results of automatic test with an included control LED
- Operation of integrated emergency lighting function with long life LiFePO4 battery with 3h battery discharge time
- TP(a) rated BS2782-0:2011



## PANEL IP54

  IP54  LEDVANCE <sup>1</sup>  
5 year guarantee

Product name	Static Code	GTIN (EAN)	W	lm	lm/w		L70 <sup>2</sup>	L80 <sup>2</sup>	IK	L x W x H [mm] Ø x H [mm]
--------------	-------------	------------	---	----	------	---	------------------	------------------	----	------------------------------

### PANEL 600 IP54

NEW	PANEL 600 36 W 3000 K OP IP54 WT	P60030IP	4058075149489	36	4320	120	120	80.000	60.000	IK04	595x595x13
NEW	PANEL 600 36 W 4000 K OP IP54 WT	P60040IP	4058075149502	36	4320	120	120	80.000	60.000	IK04	595x595x13

- Suitable for use in dusty and damp locations thanks to high IP rating
- High lumen output reduces the total number of panels per installation
- Energy savings of up to 50% (Compared to luminaires that use fluorescent lamps)
- Low flicker light thanks to special electronic control gear

<sup>1</sup> The exact terms and conditions can be found at [www.ledvance.co.uk/guarantee](http://www.ledvance.co.uk/guarantee) | <sup>2</sup> t[h]: L70/B50 @ 25°C (T<sub>a</sub>) / t[h]: L80/B10 @ 25°C (T<sub>a</sub>)



## PANEL IP 54 DALI



Product name	Static Code	GTIN (EAN)	W	lm	lm/W		L70 <sup>2</sup>	L80 <sup>2</sup>	IK	L x W x H [mm] Ø x H [mm]	
--------------	-------------	------------	---	----	------	--	------------------	------------------	----	------------------------------	--

### PANEL DALI 600 IP 54

NEW	PANEL 600 DALI 36 W 3000 K OP IP54 WT	VP60030DAIP	4058075217720	36	4320	120	120	80.000	60.000	IK06	595 x 595 x 13	✓
NEW	PANEL 600 DALI 36 W 4000 K OP IP54 WT	VP60040DAIP	4058075217744	36	4320	120	120	80.000	60.000	IK06	595 x 595 x 13	✓

- Suitable for use in dusty and damp locations thanks to high IP rating
- High lumen output reduces the total number of panels per installation
- Energy savings of up to 50% (Compared to luminaires that use fluorescent lamps)
- Low flicker light thanks to special electronic control gear



## PANEL PERFORMANCE HIGH OUTPUT



Product name	Static Code	GTIN (EAN)	W	lm	lm/W		L70 <sup>2</sup>	L80 <sup>2</sup>	IK	L x W x H [mm] Ø x H [mm]	
--------------	-------------	------------	---	----	------	--	------------------	------------------	----	------------------------------	--

### PANEL PFM HO 600

NEW	PANEL 600 36 W 3000 K OP WT (TP(b))	PH060030	4058075113060	36	4320	120	120	80.000	60.000	IK03	595 x 595 x 12
NEW	PANEL 600 36 W 4000 K OP WT (TP(b))	PH060040	4058075113084	36	4320	120	120	80.000	60.000	IK03	595 x 595 x 12

### PANEL PFM HO 600 UGR<19

NEW	PANEL 600 UGR<19 36 W 3000 K MP WT	PH060030U	4058075113107	36	4320	120	90	80.000	60.000	IK03	595 x 595 x 12
NEW	PANEL 600 UGR<19 36 W 4000 K MP WT	PH060040U	4058075113121	36	4320	120	90	80.000	60.000	IK03	595 x 595 x 12

- High lumen output reduces the total number of panels per installation
- Light guide plate with micro structure made of non-yellowing material for long lifetime
- Low flicker light thanks to special electronic control gear
- Energy savings of up to 50% (Compared to luminaires that use fluorescent lamps)
- UGR<19 models are low glare in compliance with BS EN12464-1

<sup>1</sup> The exact terms and conditions can be found at [www.ledvance.co.uk/guarantee](http://www.ledvance.co.uk/guarantee) | <sup>2</sup> t[h]: L70/B50 @ 25°C (T<sub>a</sub>) / t[h]: L80/B10 @ 25°C (T<sub>a</sub>)



## PANEL PERFORMANCE HIGH OUTPUT DALI



Product name	Static Code	GTIN (EAN)	W	lm	lm/W	$\Delta$	L70 <sup>2</sup>	L80 <sup>2</sup>	IK	L x W x H [mm] Ø x H [mm]	
--------------	-------------	------------	---	----	------	----------	------------------	------------------	----	------------------------------	--

### PANEL PFM HO DALI 600

NEW	PANEL 600 DALI 36 W 3000 K OP WT (TP(b))	PH060030DA	4058075113244	36	4320	120	120	80.000	60.000	IK03	595 x 595 x 12	✓
NEW	PANEL 600 DALI 36 W 4000 K OP WT (TP(b))	PH060040DA	4058075113268	36	4320	120	120	80.000	60.000	IK03	595 x 595 x 12	✓
<b>PANEL PFM HO DALI 600 UGR&lt;19</b>												
NEW	PANEL 600 DALI UGR<19 36 W 3000 K MP WT	PH0600DA30U	4058075113282	36	4320	120	90	80.000	60.000	IK03	595 x 595 x 12	✓
NEW	PANEL 600 DALI UGR<19 36 W 4000 K MP WT	PH0600DA40U	4058075113305	36	4320	120	90	80.000	60.000	IK03	595 x 595 x 12	✓

- High lumen output reduces the total number of panels per installation
- Light guide plate with micro structure made of non-yellowing material for long lifetime
- Low flicker light thanks to special electronic control gear
- Energy savings of up to 50% (Compared to luminaires that use fluorescent lamps)
- UGR<19 models are low glare in compliance with BS EN12464-1



1

2

## PANEL PERFORMANCE



Product name	Static Code	GTIN (EAN)	W	lm	lm/W	$\Delta$	L70 <sup>2</sup>	L80 <sup>2</sup>	IK	L x W x H [mm] Ø x H [mm]	
--------------	-------------	------------	---	----	------	----------	------------------	------------------	----	------------------------------	--

### PANEL PERFORMANCE 600

NEW	PANEL PFM 600 30 W 3000 K WT	PP60030	4058075225152	30	3000	100	120	80.000	60.000	IK03	595 x 595 x 9	1
NEW	PANEL PFM 600 30 W 4000 K WT	PP60040	4058075225176	30	3000	100	120	80.000	60.000	IK03	595 x 595 x 9	1
NEW	PANEL PFM 600 40 W 3000 K WT	PP60030HL	4058075225190	40	4000	100	120	80.000	60.000	IK03	595 x 595 x 9	1
NEW	PANEL PFM 600 40 W 4000 K WT	PP60040HL	4058075225213	40	4000	100	120	80.000	60.000	IK03	595 x 595 x 9	1

### PANEL PERFORMANCE 1200

	PANEL 1200 40 W 3000 K WT	PP12330	4058075321809	40	4000	100	120	60.000	40.000	IK06	1195 x 295 x 11	2
NEW	PANEL 1200 40 W 4000 K WT	PP12340	4058075182035	40	4000	100	120	60.000	40.000	IK06	1195 x 295 x 11	2

- Energy savings of up to 50% (Compared to luminaires that use fluorescent lamps)
- External driver for extended flexibility
- Light guide plate with micro structure made of non-yellowing material for long lifetime
- Easy and quick installation
- Low flicker light thanks to special electronic control gear

<sup>1</sup> The exact terms and conditions can be found at [www.ledvance.co.uk/guarantee](http://www.ledvance.co.uk/guarantee) | <sup>2</sup> t[h]: L70/B50 @ 25°C (T<sub>a</sub>) / t[h]: L80/B10 @ 25°C (T<sub>a</sub>)





1

2

## PANEL PERFORMANCE UGR<19

IP 20

LEDVANCE  
5 year  
guarantee

Product name

Static Code

GTIN (EAN)

L x W x H [mm]  
Ø x H [mm]

### PANEL PERFORMANCE 600 UGR<19

NEW	PANEL PFM 600 UGR<19 33 W 3000 K WT	PP60030U	4058075225237	33	3100	100	90	80.000	60.000	IK03	595x595x9	1
NEW	PANEL PFM 600 UGR<19 33 W 4000 K WT	PP60040U	4058075225251	33	3600	110	90	80.000	60.000	IK03	595x595x9	1
<b>PANEL PERFORMANCE 1200 UGR&lt;19</b>												
NEW	PANEL 1200 UGR<19 33 W 4000 K WT	PP12340U	4058075182059	33	3300	100	90	60.000	40.000	IK06	1195x295x11	2
	PANEL 1200 UGR<19 33 W 3000 K WT	PP12330U	4058075321786	33	3100	95	90	60.000	40.000	IK06	1195x295x11	2

- Good glare reduction (UGR<19) in compliance with BS EN12464-1
- Energy savings of up to 50% (Compared to luminaires that use fluorescent lamps)
- External driver for extended flexibility
- Light guide plate with micro structure made of non-yellowing material for long lifetime
- Easy and quick installation
- Low flicker light thanks to special electronic control gear



1

2

## PANEL PERFORMANCE DALI

IP 20

LEDVANCE  
5 year  
guarantee

Product name

Static Code

GTIN (EAN)

L x W x H [mm]  
Ø x H [mm]

### PANEL PERFORMANCE DALI 600

NEW	PANEL PFM DALI 600 40 W 3000 K WT	PP60030DA	4058075225398	40	4000	100	120	80.000	60.000	IK03	595x595x9	✓	1
NEW	PANEL PFM DALI 600 40 W 4000 K WT	PP60040DA	4058075225411	40	4000	100	120	80.000	60.000	IK03	595x595x9	✓	1
<b>PANEL PERFORMANCE DALI 1200</b>													
	PANEL 1200 DALI 40 W 3000 K WT	PP12330DA	4058075042018	40	4000	100	120	50.000	40.000	IK06	1195x295x11	✓	2
	PANEL 1200 DALI 40 W 4000 K WT	PP12340DA	4058075041998	40	4000	100	120	50.000	40.000	IK06	1195x295x11	✓	2

- Energy savings of up to 50% (Compared to luminaires that use fluorescent lamps)
- Advanced functionality due to external DALI driver
- Light guide plate with micro structure made of non-yellowing material for long lifetime
- Easy and quick installation
- Low flicker light thanks to special electronic control gear

<sup>1</sup> The exact terms and conditions can be found at [www.ledvance.co.uk/guarantee](http://www.ledvance.co.uk/guarantee) | <sup>2</sup> t[h]: L70/B50 @ 25°C (T<sub>a</sub>) / t[h]: L80/B10 @ 25°C (T<sub>a</sub>)



## PANEL PERFORMANCE DALI UGR<19



Product name	Static Code	GTIN (EAN)	W	lm	lm/W	°	L70 <sup>2</sup>	L80 <sup>2</sup>	IK	L x W x H [mm] Ø x H [mm]	Icon	No.
--------------	-------------	------------	---	----	------	---	------------------	------------------	----	------------------------------	------	-----

### PANEL PERFORMANCE DALI 600 UGR<19

NEW	PANEL PFM DALI 600 UGR<19 33 W 3000 K WT	PP60030UDA	4058075225435	33	3100	95	90	80.000	60.000	IK03	595 x 595 x 9	✓	1
NEW	PANEL PFM DALI 600 UGR<19 33 W 4000 K WT	PP60040UDA	4058075225459	33	3600	110	90	80.000	60.000	IK03	595 x 595 x 9	✓	1

### PANEL PERFORMANCE DALI 1200 UGR<19

	PANEL 1200 DALI UGR<19 33 W 3000 K WT	PP12330UDA	4058075041950	33	3100	95	90	50.000	40.000	IK06	1195 x 295 x 11	✓	2
	PANEL 1200 DALI UGR<19 33 W 4000 K WT	PP12330UDA	4058075041974	33	3300	110	90	50.000	40.000	IK06	1195 x 295 x 11	✓	2

- Good glare reduction (UGR<19) in compliance with BS EN12464-1
- Energy savings of up to 50% (Compared to luminaires that use fluorescent lamps)
- Advanced functionality due to external DALI driver
- Light guide plate with micro structure made of non-yellowing material for long lifetime
- Easy and quick installation
- Low flicker light thanks to special electronic control gear

## UK PANEL PERFORMANCE



Product name	Static Code	GTIN (EAN)	W	lm	lm/W	°	L70 <sup>2</sup>	L80 <sup>2</sup>	IK	L x W x H [mm] Ø x H [mm]	Icon	No.
--------------	-------------	------------	---	----	------	---	------------------	------------------	----	------------------------------	------	-----

### LED Panel Luminaires

NEW	PANEL PFM PFM 600 36W/4000K UGR19 TP(a)	PP60040UTPA	4058075384309	36	3960	110	90	50.000	50.000	IK02	595 x 595 x 35		1
NEW	PANEL PFM PFM DALI 600 36W/4000K UGR19 TP(a)	PP60040UDATPA	4058075384323	36	3960	110	90	50.000	50.000	IK02	595 x 595 x 35	✓	1
NEW	PANEL PFM VAL 600 36W/4000K TP(b)	VPL60040	4058075384347	36	3200	90	120	50.000	50.000	IK02	595 x 595 x 35		3
NEW	PANEL PFM VAL 1200x600 36W/4000K TP(b)	VPL12640	4058075384361	65	5800	90	120	50.000	50.000	IK02	1195 x 595 x 35		3

### Product Benefits Panel Performance TP(a)

- Energy savings thanks to system efficacy of up to 110 lm/W
- Flexible applications with no positioning restrictions due to TP(a) rated diffuser in compliance with BS 8782-0:2011
- Low glare reduction (UGR<19) compliance with BS EN12464-1
- Further variants with DALI ECG available
- Emergency versions with LEDVANCE Emergency Conversion Box (See page 85)
- Low flicker rating thanks to special electronic control gear
- External driver for extended flexibility and easy installation
- Easy cleaning maintenance due to smooth diffuser
- 5 year guarantee for TP(a) model

### Product Benefits Panel Value TP(b)

- Low flicker rating thanks to special electronic control gear
- External driver for extended flexibility and easy installation
- Emergency versions with LEDVANCE Emergency Conversion Box (See page 85)
- 3 year guarantee for TP(b) model

<sup>1</sup> The exact terms and conditions can be found at [www.ledvance.co.uk/guarantee](http://www.ledvance.co.uk/guarantee) | <sup>2</sup> t[h]: L70/B50 @ 25°C (T<sub>a</sub>) / t[h]: L80/B10 @ 25°C (T<sub>a</sub>)



## PANEL VALUE

IP20

LEDVANCE  
3 year  
guarantee

Product name	Static Code	GTIN (EAN)	W	lm	lm/W	$\Delta$	L70 <sup>2</sup>	L80 <sup>2</sup>	IK	L x W x H [mm] Ø x H [mm]
<b>PANEL VALUE 600</b>										
PANEL VALUE 600 40 W 3000 K WT	VP60030	4058075066588	40	3300	85	120	50.000	40.000	IK03	595 x 595 x 9
PANEL VALUE 600 40 W 4000 K WT	VP60040	4058075066601	40	3600	90	120	50.000	40.000	IK03	595 x 595 x 9
PANEL VALUE 600 40 W 6500 K WT	VP60065	4058075066625	40	3600	90	120	50.000	40.000	IK03	595 x 595 x 9
<b>PANEL VALUE 600 UGR&lt;19</b>										
PANEL VALUE 600 UGR<19 40 W 3000 K WT	VP60030U	4058075066649	40	3300	85	90	50.000	40.000	IK03	595 x 595 x 9
PANEL VALUE 600 UGR<19 40 W 4000 K WT	VP60040U	4058075066663	40	3600	90	90	50.000	40.000	IK03	595 x 595 x 9

- Value for money luminaire
- Light guide plate with micro structure made of non-yellowing material for long lifetime
- Low flicker light thanks to special electronic control gear
- External driver for extended flexibility
- TP(b) rated BS2782-0:2011
- UGR<19 models are low glare in compliance with BS EN12464-1



## PANEL VALUE EMERGENCY

IP20

LEDVANCE  
3 year  
guarantee

Product name	Static Code	GTIN (EAN)	W	lm	lm/W	$\Delta$	L70 <sup>2</sup>	L80 <sup>2</sup>	IK	L x W x H [mm] Ø x H [mm]
<b>PANEL VALUE 600 EMERGENCY</b>										
<b>NEW</b> PANEL VAL 600 EM 40 W 3000 K AT 3H	VP60030EM	4058075204089	40	3300	85	120	50.000	40.000	IK03	595 x 595 x 9
<b>NEW</b> PANEL VAL 600 EM 40 W 4000 K AT 3H	VP60040EM	4058075204102	40	3600	90	120	50.000	40.000	IK03	595 x 595 x 9
<b>NEW</b> PANEL VAL 600 EM 40 W 6500 K AT 3H	VP60065EM	4058075204126	40	3600	90	120	50.000	40.000	IK03	595 x 595 x 9
<b>PANEL VALUE 600 EMERGENCY UGR&lt;19</b>										
<b>NEW</b> PANEL VAL 600 EM 40 W 3000 K UGR19 AT 3H	VP60030UEM	4058075204140	40	3300	85	90	50.000	40.000	IK03	595 x 595 x 9
<b>NEW</b> PANEL VAL 600 EM 40 W 4000 K UGR19 AT 3H	VP60040UEM	4058075204164	40	3600	90	90	50.000	40.000	IK03	595 x 595 x 9

- Seamless integration of luminaires with emergency lighting function into general lighting
- Easy wiring thanks to included prewired driver and battery for Emergency lighting function
- Simple testing of luminaires with emergency lighting function thanks to integrated automatic test function
- Convenient visualization of results of automatic test with an included control LED
- Operation of integrated emergency lighting function with long life LiFePO4 battery with 3h battery discharge time
- Value for money luminaire
- TP(b) rated BS2782-0:2011
- UGR<19 models are low glare in compliance with BS EN12464-1

<sup>1</sup> The exact terms and conditions can be found at [www.ledvance.co.uk/guarantee](http://www.ledvance.co.uk/guarantee) | <sup>2</sup> t[h]: L70/B50 @ 25°C (T<sub>a</sub>) / t[h]: L80/B10 @ 25°C (T<sub>a</sub>)

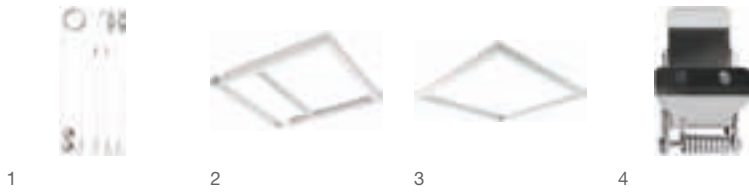

## PANEL 600 ACCESSORIES

LEDVANCE  
2 year guarantee

Product name	Static Code	GTIN (EAN)	L x W x H [mm] Ø x H [mm]	No.
<b>PANEL 600 SUSPENSION KIT</b>				
PANEL 600 Suspension Kit	PSUS600	4058075108868	- x - x -	1
<b>SURFACE MOUNT KIT</b>				
PANEL 600 Surface Mount Kit	PSUR600	4058075108769	601 x 601 x 56	2
<b>SURFACE MOUNT KIT VALUE</b>				
PANEL 600 Surface Mount Kit Value	VSUR600	4058075075795	601 x 601 x 45	3
<b>PANEL MOUNTING CLIPS 1x4</b>				
PANEL Mounting Clips 1x4	PCLIP	4058075109421	35 x 30 x 45	4

— Pendant length for different applications adjustable by screws



## PANEL 1200 ACCESSORIES

LEDVANCE  
2 year guarantee

Product name	Static Code	GTIN (EAN)	L x W x H [mm] Ø x H [mm]
<b>PANEL 1200 Accessories</b>			
PANEL 1200 Suspension Kit	PSUS123	4058075108844	- x - x -
PANEL 1200 Surface Mount Kit	PSUR123	4058075108820	1201 x 301 x 56
PANEL 1200 Surface Mount Kit Value	VPSUR123	4058075091429	1201 x 301 x 45
PANEL 1200 Security Bracket	PSECBKT123	4058075108882	25 x 20 x 20

<sup>1</sup> The exact terms and conditions can be found at [www.ledvance.co.uk/guarantee](http://www.ledvance.co.uk/guarantee)



Level 3  
Nurses Station

# SUSPENDED LUMINAIRES

## OFFICE LUMINAIRES FROM LEDVANCE: PLEASANT LIGHT FOR GOOD RESULTS

High quality light at the workplace can have a positive impact on the well-being and the visual comfort of employees. LEDVANCE suspended luminaires offer a comfortable and efficient solution for office lighting with a mix of direct and indirect lighting. All the luminaires are glare-free and comply with European requirements according to EN 12464-1.



### LEDVANCE PANEL DIRECT/INDIRECT

Modern suspended luminaires with attractive direct (70%) and indirect (30%) illumination.

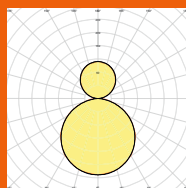

Light distribution curve

Extremely homogeneous and controlled distribution of light





## PANEL DIRECT/INDIRECT 1200 UGR<19



Product name	Static Code	GTIN (EAN)	W	lm	lm/W	$\theta$	L70 <sup>2</sup>	L80 <sup>2</sup>	IK	L x W x H [mm] Ø x H [mm]
--------------	-------------	------------	---	----	------	----------	------------------	------------------	----	------------------------------

### PANEL DIRECT/INDIRECT 1200 UGR<19

NEW	PANEL D/I 1200 UGR<19 36 W 3000 K WT	PDI12330U	4058075144606	36	3850	100	110	80.000	60.000	IK03	1200x300x16
NEW	PANEL D/I 1200 UGR<19 36 W 4000 K WT	PDI12340U	4058075144620	36	3860	110	110	80.000	60.000	IK03	1200x300x16

- Suspended edge-lit luminaires for direct light emission (70%) and indirect light emission (30%)
- Attractive and functional design for office applications
- Good glare reduction (UGR<19) in compliance with BS EN12464-1
- Very homogenous light
- Low maintenance and low operational costs
- External driver for extended flexibility



## PANEL DIRECT/INDIRECT DALI 1200 UGR<19



Product name	Static Code	GTIN (EAN)	W	lm	lm/W	$\theta$	L70 <sup>2</sup>	L80 <sup>2</sup>	IK	L x W x H [mm] Ø x H [mm]	
--------------	-------------	------------	---	----	------	----------	------------------	------------------	----	------------------------------	--

### PANEL DIRECT/INDIRECT DALI 1200 UGR<19

NEW	PANEL D/I DALI 1200 UGR<19 36 W 3000 K WT	PDI1230UDA	4058075144644	36	3850	100	110	80.000	60.000	IK03	1200x300x16	✓
NEW	PANEL D/I DALI 1200 UGR<19 36 W 4000 K WT	PDI1240UDA	4058075144668	36	3860	110	110	80.000	60.000	IK03	1200x300x16	✓

- Suspended edge-lit luminaires for direct light emission (70%) and indirect light emission (30%)
- Advanced functionality due to already included DALI driver
- Attractive and functional design for office applications
- Good glare reduction (UGR<19) in compliance with BS EN12464-1
- Very homogenous light
- Low maintenance and low operational costs

<sup>1</sup> The exact terms and conditions can be found at [www.ledvance.co.uk/guarantee](http://www.ledvance.co.uk/guarantee) | <sup>2</sup> t[h]: L70/B50 @ 25°C (T<sub>a</sub>) / t[h]: L80/B10 @ 25°C (T<sub>a</sub>)



## LINEAR IndiviLED DIRECT/INDIRECT



Product name	Static Code	GTIN (EAN)	W	lm	lm/W	$\alpha$	L70 <sup>2</sup>	L80 <sup>2</sup>	IK	L x W x H [mm] Ø x H [mm]
--------------	-------------	------------	---	----	------	----------	------------------	------------------	----	------------------------------

### LINEAR IndiviLED® DIRECT/INDIRECT

NEW	LN INDV D/I 1200 42 W 3000 K	INDI42W30	4058075109728	42	4650	110	70	60.000	50.000	IK06	1199 x 120 x 40
NEW	LN INDV D/I 1200 42 W 4000 K	INDI42W40	4058075109742	42	5050	120	70	60.000	50.000	IK06	1199 x 120 x 40
NEW	LN INDV D/I 1500 56 W 3000 K	INDI58W30	4058075109766	56	6150	110	70	60.000	50.000	IK06	1488 x 120 x 40
NEW	LN INDV D/I 1500 56 W 4000 K	INDI58W40	4058075110441	56	6550	115	70	60.000	50.000	IK06	1488 x 120 x 40

- Homogenous light distribution and reduced glare thanks to the IndiviLED optics
- Increased light comfort thanks to direct and indirect light emission
- The product family offers full lighting solution for different applications
- Energy savings of up to 50% compared to T5 batten luminaires
- Robust structure with IK06



## LINEAR IndiviLED DIRECT/INDIRECT DALI



Product name	Static Code	GTIN (EAN)	W	lm	lm/W	$\alpha$	L70 <sup>2</sup>	L80 <sup>2</sup>	IK	L x W x H [mm] Ø x H [mm]	
--------------	-------------	------------	---	----	------	----------	------------------	------------------	----	------------------------------	--

### LINEAR IndiviLED® DIRECT/INDIRECT DALI

NEW	LN INDV D/I DALI 1200 42 W 3000 K	INDI42W30DA	4058075109001	42	4650	110	70	60.000	50.000	IK06	1199 x 120 x 40	✓
NEW	LN INDV D/I DALI 1200 42 W 4000 K	INDI42W40DA	4058075109025	42	5050	120	70	60.000	50.000	IK06	1199 x 120 x 40	✓
NEW	LN INDV D/I DALI 1500 56 W 3000 K	INDI58W30DA	4058075109049	56	6150	110	70	60.000	50.000	IK06	1488 x 120 x 40	✓
NEW	LN INDV D/I DALI 1500 56 W 4000 K	INDI58W40DA	4058075109063	56	6550	115	70	60.000	50.000	IK06	1488 x 120 x 40	✓

- Homogenous light distribution and reduced glare thanks to the IndiviLED optics
- Advanced functionality due to already included DALI driver
- Increased light comfort thanks to direct and indirect light emission
- Energy savings of up to 50% compared to T5 batten luminaires
- Robust structure with IK06

<sup>1</sup> The exact terms and conditions can be found at [www.ledvance.co.uk/guarantee](http://www.ledvance.co.uk/guarantee) | <sup>2</sup> t[h]: L70/B50 @ 25°C (T<sub>a</sub>) / t[h]: L80/B10 @ 25°C (T<sub>a</sub>)





## LINEAR IndiviLED DIRECT/INDIRECT SENSOR



Product name

Static Code

GTIN (EAN)

L x W x H [mm]  
Ø x H [mm]

## LINEAR IndiviLED® DIRECT/INDIRECT SENSOR

	Product name	Static Code	GTIN (EAN)	W	lm	lm/W	Beam angle	L70 <sup>2</sup>	L80 <sup>2</sup>	IK	L x W x H [mm] Ø x H [mm]
NEW	LN INDV D/1 1200 42 W 3000 K S	INDI42W30S	4058075109445	42	4650	110	70	60.000	50.000	IK06	1229x120x40
NEW	LN INDV D/1 1200 42 W 4000 K S	INDI42W40S	4058075109469	42	5050	120	70	60.000	50.000	IK06	1229x120x40
NEW	LN INDV D/1 1500 56 W 3000 K S	INDI58W30S	4058075109483	56	6150	110	70	60.000	50.000	IK06	1518x120x40
NEW	LN INDV D/1 1500 56 W 4000 K S	INDI58W40S	4058075109506	56	6550	115	70	60.000	50.000	IK06	1518x120x40

- Homogenous light distribution and reduced glare thanks to the IndiviLED optics
- Allows for energy savings and comfortable operation due to sensor control
- Increased light comfort thanks to direct and indirect light emission
- Low flicker light thanks to special electronic control gear
- Energy savings of up to 50% compared to T5 batten luminaires
- Robust structure with IK06



## LINEAR IndiviLED DIRECT/INDIRECT DALI SENSOR



Product name

Static Code

GTIN (EAN)

L x W x H [mm]  
Ø x H [mm]

## LINEAR IndiviLED® DIRECT/INDIRECT DALI SENSOR

	Product name	Static Code	GTIN (EAN)	W	lm	lm/W	Beam angle	L70 <sup>2</sup>	L80 <sup>2</sup>	IK	L x W x H [mm] Ø x H [mm]	
NEW	LN INDV D/1 DALI 1200 42 W 3000 K S	INDI42W30DAS	4058075110045	42	4650	110	70	60.000	50.000	IK06	1229x120x40	✓
NEW	LN INDV D/1 DALI 1200 42 W 4000 K S	INDI42W40DAS	4058075110069	42	5050	120	70	60.000	50.000	IK06	1229x120x40	✓
NEW	LN INDV D/1 DALI 1500 56 W 3000 K S	INDI58W30DAS	4058075110083	56	6150	110	70	60.000	50.000	IK06	1518x120x40	✓
NEW	LN INDV D/1 DALI 1500 56 W 4000 K S	INDI58W40DAS	4058075110106	56	6550	115	70	60.000	50.000	IK06	1518x120x40	✓

- Homogenous light distribution and reduced glare thanks to the IndiviLED optics
- Advanced functionality due to already included DALI driver
- Low flicker light thanks to special electronic control gear
- Increased light comfort thanks to direct and indirect light emission
- Energy savings of up to 50% compared to T5 batten luminaires
- Robust structure with IK06

<sup>1</sup> The exact terms and conditions can be found at [www.ledvance.co.uk/guarantee](http://www.ledvance.co.uk/guarantee) | <sup>2</sup> t[h]: L70/B50 @ 25°C (T<sub>a</sub>) / t[h]: L80/B10 @ 25°C (T<sub>a</sub>)



## LINEAR IndiviLED DIRECT/INDIRECT EMERGENCY



Product name	Static Code	GTIN (EAN)	W	lm	lm/W		L70 <sup>2</sup>	L80 <sup>2</sup>	IK	L x W x H [mm] Ø x H [mm]
--------------	-------------	------------	---	----	------	--	------------------	------------------	----	------------------------------

### LINEAR IndiviLED® DIRECT/INDIRECT EMERGENCY

NEW	LN INDV D/1 1200 42 W 3000 K EM	INDI42W30EM	4058075109841	42	4650	110	70	60.000	50.000	IK06	1199 x 120 x 40
NEW	LN INDV D/1 1200 42 W 4000 K EM	INDI42W40EM	4058075109865	42	5050	120	70	60.000	50.000	IK06	1199 x 120 x 40
NEW	LN INDV D/1 1500 56 W 3000 K EM	INDI58W30EM	4058075109889	56	6150	110	70	60.000	50.000	IK06	1488 x 120 x 40
NEW	LN INDV D/1 1500 56 W 4000 K EM	INDI58W40EM	4058075109902	56	6550	115	70	60.000	50.000	IK06	1488 x 120 x 40

- Homogenous light distribution and reduced glare thanks to the IndiviLED optics
- Emergency lighting according to IEC 60598-2-22 with emergency lighting driver and battery
- Low flicker light thanks to special electronic control gear
- Increased light comfort thanks to direct and indirect light emission
- Energy savings of up to 50% compared to T5 batten luminaires
- Robust structure with IK06



## LINEAR IndiviLED DIRECT/INDIRECT THROUGH-WIRED



Product name	Static Code	GTIN (EAN)	W	lm	lm/W		L70 <sup>2</sup>	L80 <sup>2</sup>	IK	L x W x H [mm] Ø x H [mm]
--------------	-------------	------------	---	----	------	--	------------------	------------------	----	------------------------------

### LINEAR IndiviLED® DIRECT/INDIRECT THROUGH-WIRED

NEW	LN INDV D/1 1200 42 W 3000 K TH	INDITH42W30	4058075109209	42	4650	110	70	60.000	50.000	IK06	1199 x 120 x 40
NEW	LN INDV D/1 1200 42 W 4000 K TH	INDITH42W40	4058075109223	42	5050	120	70	60.000	50.000	IK06	1199 x 120 x 40
NEW	LN INDV D/1 1500 56 W 3000 K TH	INDITH58W30	4058075109247	56	6150	110	70	60.000	50.000	IK06	1488 x 120 x 40
NEW	LN INDV D/1 1500 56 W 4000 K TH	INDITH58W40	4058075109261	56	6550	115	70	60.000	50.000	IK06	1488 x 120 x 40

- Homogenous light distribution and reduced glare thanks to the IndiviLED optics
- Convenient installation of light lines due to pre-assembled through wiring kit
- Increased light comfort thanks to direct and indirect light emission
- Low flicker light thanks to special electronic control gear
- Energy savings of up to 50% compared to T5 batten luminaires
- Robust structure with IK06

<sup>1</sup> The exact terms and conditions can be found at [www.ledvance.co.uk/guarantee](http://www.ledvance.co.uk/guarantee) | <sup>2</sup> t[h]: L70/B50 @ 25°C (T<sub>a</sub>) / t[h]: L80/B10 @ 25°C (T<sub>a</sub>)

# OUR CHECKLIST FOR YOUR LINEAR INDIVILED® DIRECT/INDIRECT DALI SYSTEM

**Typical installation:** We have put together for you all the necessary components for suspended installation of three luminaires as strip lighting. For more information see the operating instructions for Linear IndiviLED® Direct/Indirect.

**UP TO 20 LUMINAIRES!**

## INSTALLATION OF 3 × LINEAR INDIVILED® DIRECT/INDIRECT DALI

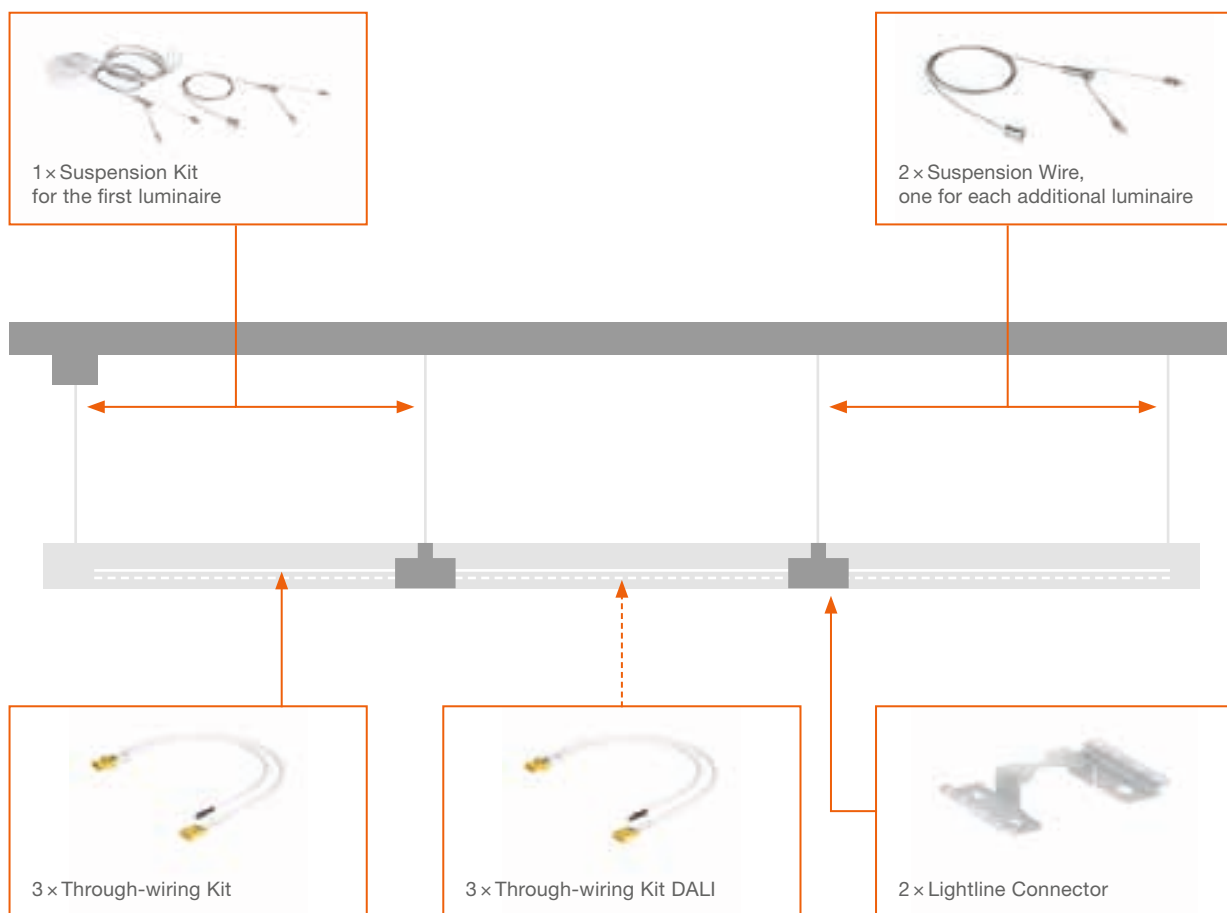

The through-wiring must be fitted by an installer.



### ORDER LIST

- 3 × Linear IndiviLED® Direct/Indirect
- 3 × Through-wiring Kit
- 3 × Through-wiring Kit DALI
- 2 × Lightline Connector
- 1 × Suspension Kit
- 2 × Suspension Wire



# LINEAR LUMINAIRES

## LINEAR LUMINAIRES FROM LEDVANCE: HIGH LEVELS OF COMFORT AND FLEXIBILITY

The large portfolio of LEDVANCE linear luminaires replaces luminaires with traditional T8/T5 fluorescent tubes. The luminaires can be used in a wide variety of applications and forms as single luminaires or complete lighting strips. Among other things, LEDVANCE Linear IndiviLED® Direct offers uniform light distribution and reduced glare thanks to IndiviLED® optics.

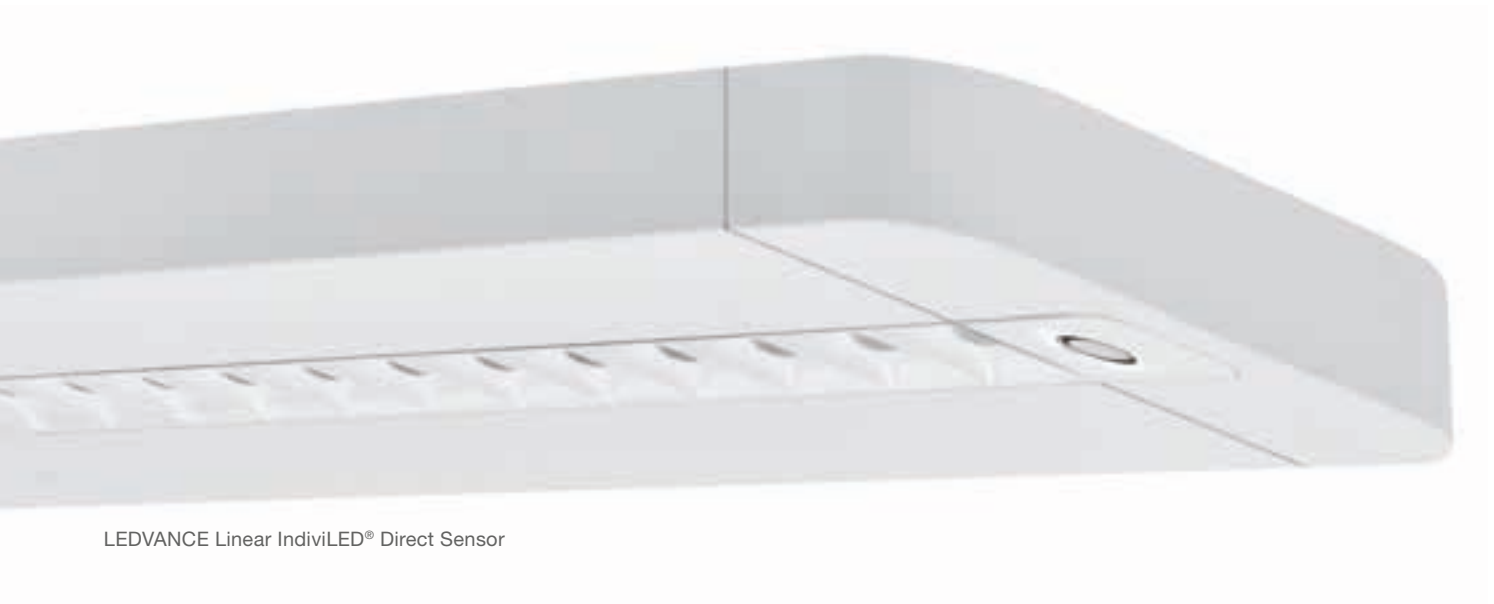

LEDVANCE Linear IndiviLED® Direct Sensor

### WHICH LUMINAIRE IS SUITABLE FOR WHICH APPLICATION?

Linear IndiviLED® Direct

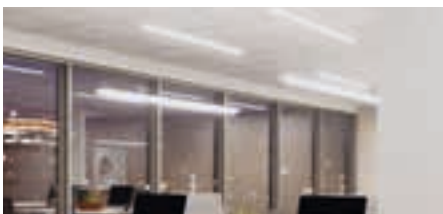

Office

Linear Ultra Output



Industry, general lighting

Linear Compact



Cove lighting, shop and hospitality



## LINEAR IndiviLED DIRECT



Product name	Static Code	GTIN (EAN)	W	lm	lm/W	$\alpha$	L70 <sup>2</sup>	L80 <sup>2</sup>	IK	L x W x H [mm] Ø x H [mm]
--------------	-------------	------------	---	----	------	----------	------------------	------------------	----	------------------------------

### LINEAR IndiviLED® DIRECT

NEW	LN INDV D 1200 34 W 3000 K	IND33W30	4058075109605	34	3800	110	70	60.000	50.000	IK06	1199 x 120 x 40
NEW	LN INDV D 1200 34 W 4000 K	IND33W40	4058075109629	34	4200	120	70	60.000	50.000	IK06	1199 x 120 x 40
NEW	LN INDV D 1500 25 W 3000 K	IND25W30	4058075109643	25	3100	125	70	60.000	50.000	IK06	1488 x 120 x 40
NEW	LN INDV D 1500 25 W 4000 K	IND25W40	4058075109667	25	3300	125	70	60.000	50.000	IK06	1488 x 120 x 40
NEW	LN INDV D 1500 48 W 3000 K	IND50W30	4058075109681	48	5300	110	70	60.000	50.000	IK06	1488 x 120 x 40
NEW	LN INDV D 1500 48 W 4000 K	IND50W40	4058075109704	48	5700	120	70	60.000	50.000	IK06	1488 x 120 x 40

- Homogenous light distribution and reduced glare thanks to the IndiviLED optics
- Multiple mounting options
- The product family offers full lighting solution for different applications
- Energy savings of up to 50% compared to T5 batten luminaires
- Further variants with DALI ECG, sensor, emergency lighting function according to IEC 60598-2-22 or through wiring additionally available
- Robust structure with IK06
- UGR<16



## LINEAR IndiviLED DIRECT DALI



Product name	Static Code	GTIN (EAN)	W	lm	lm/W	$\alpha$	L70 <sup>2</sup>	L80 <sup>2</sup>	IK	L x W x H [mm] Ø x H [mm]	
--------------	-------------	------------	---	----	------	----------	------------------	------------------	----	------------------------------	--

### LINEAR IndiviLED® DIRECT DALI

NEW	LN INDV D DALI 1200 34 W 3000 K	IND33W30DA	4058075108806	34	3800	110	70	60.000	50.000	IK06	1199 x 120 x 40	✓
NEW	LN INDV D DALI 1200 34 W 4000 K	IND33W40DA	4058075108905	34	4200	120	70	60.000	50.000	IK06	1199 x 120 x 40	✓
NEW	LN INDV D DALI 1500 25 W 3000 K	IND25W30DA	4058075108929	25	3100	125	70	60.000	50.000	IK06	1488 x 120 x 40	✓
NEW	LN INDV D DALI 1500 25 W 4000 K	IND25W40DA	4058075108943	25	3300	125	70	60.000	50.000	IK06	1488 x 120 x 40	✓
NEW	LN INDV D DALI 1500 48 W 3000 K	IND50W30DA	4058075108967	48	5300	110	70	60.000	50.000	IK06	1488 x 120 x 40	✓
NEW	LN INDV D DALI 1500 48 W 4000 K	IND50W40DA	4058075108981	48	5700	120	70	60.000	50.000	IK06	1488 x 120 x 40	✓

- Homogenous light distribution and reduced glare thanks to the IndiviLED optics
- Advanced functionality due to already included DALI driver
- Multiple mounting options
- Low flicker light thanks to special electronic control gear
- Energy savings of up to 50% compared to T5 batten luminaires
- Further variants with sensor, emergency lighting function according to IEC 60598-2-22 or through wiring additionally available
- UGR<16

<sup>1</sup> The exact terms and conditions can be found at [www.ledvance.co.uk/guarantee](http://www.ledvance.co.uk/guarantee) | <sup>2</sup> t[h]: L70/B50 @ 25°C (T<sub>a</sub>) / t[h]: L80/B10 @ 25°C (T<sub>a</sub>)



## LINEAR IndiviLED DIRECT SENSOR



Product name	Static Code	GTIN (EAN)	W	lm	lm/W	$\Delta$	L70 <sup>2</sup>	L80 <sup>2</sup>	IK	L x W x H [mm]	$\varnothing$ x H [mm]
--------------	-------------	------------	---	----	------	----------	------------------	------------------	----	----------------	------------------------

### LINEAR IndiviLED® DIRECT SENSOR

NEW	LN INDV D 1200 34 W 3000 K S	IND33W30S	4058075109285	34	3800	110	70	60.000	50.000	IK06	1229x120x40
NEW	LN INDV D 1200 34 W 4000 K S	IND33W40S	4058075109308	34	4200	120	70	60.000	50.000	IK06	1229x120x40
NEW	LN INDV D 1500 25 W 3000 K S	IND25W30S	4058075109322	25	3100	125	70	60.000	50.000	IK06	1518x120x40
NEW	LN INDV D 1500 25 W 4000 K S	IND25W40S	4058075109360	25	3300	125	70	60.000	50.000	IK06	1518x120x40
NEW	LN INDV D 1500 48 W 3000 K S	IND50W30S	4058075109384	48	5300	110	70	60.000	50.000	IK06	1518x120x40
NEW	LN INDV D 1500 48 W 4000 K S	IND50W40S	4058075109407	48	5700	120	70	60.000	50.000	IK06	1518x120x40

- Homogenous light distribution and reduced glare thanks to the IndiviLED optics
- Allows for energy savings and comfortable operation due to sensor control
- Multiple mounting options
- Low flicker light thanks to special electronic control gear
- Energy savings of up to 50% compared to T5 batten luminaires
- Further variants with DALI ECG, emergency lighting function according to IEC 60598-2-22 or through wiring additionally available



## LINEAR IndiviLED DIRECT DALI SENSOR



Product name	Static Code	GTIN (EAN)	W	lm	lm/W	$\Delta$	L70 <sup>2</sup>	L80 <sup>2</sup>	IK	L x W x H [mm]	$\varnothing$ x H [mm]
--------------	-------------	------------	---	----	------	----------	------------------	------------------	----	----------------	------------------------

### LINEAR IndiviLED® DIRECT DALI SENSOR

NEW	LN INDV D DALI 1200 34 W 3000 K S	IND33W30DAS	4058075109926	34	3800	110	70	60.000	50.000	IK06	1229x120x40	✓
NEW	LN INDV D DALI 1200 34 W 4000 K S	IND33W40DAS	4058075109940	34	4200	120	70	60.000	50.000	IK06	1229x120x40	✓
NEW	LN INDV D DALI 1500 25 W 3000 K S	IND25W30DAS	4058075109964	25	3100	125	70	60.000	50.000	IK06	1518x120x40	✓
NEW	LN INDV D DALI 1500 25 W 4000 K S	IND25W40DAS	4058075109988	25	3300	125	70	60.000	50.000	IK06	1518x120x40	✓
NEW	LN INDV D DALI 1500 48 W 3000 K S	IND50W30DAS	4058075110007	48	5300	110	70	60.000	50.000	IK06	1518x120x40	✓
NEW	LN INDV D DALI 1500 48 W 4000 K S	IND50W40DAS	4058075110021	48	5700	120	70	60.000	50.000	IK06	1518x120x40	✓

- Homogenous light distribution and reduced glare thanks to the IndiviLED optics
- Low flicker light thanks to special electronic control gear
- Advanced functionality due to already included DALI driver
- Multiple mounting options
- Energy savings of up to 50% compared to T5 batten luminaires
- Further variants with emergency lighting function according to IEC 60598-2-22 or through wiring additionally available

<sup>1</sup> The exact terms and conditions can be found at [www.ledvance.co.uk/guarantee](http://www.ledvance.co.uk/guarantee) | <sup>2</sup> t[h]: L70/B50 @ 25°C (T<sub>a</sub>) / t[h]: L80/B10 @ 25°C (T<sub>a</sub>)



## LINEAR IndiviLED DIRECT EMERGENCY



Product name	Static Code	GTIN (EAN)	W	lm	lm/W	$\Delta$	L70 <sup>2</sup>	L80 <sup>2</sup>	IK	L x W x H [mm] Ø x H [mm]
--------------	-------------	------------	---	----	------	----------	------------------	------------------	----	------------------------------

## LINEAR IndiviLED® DIRECT EMERGENCY

NEW	LN INDV D 1200 34 W 3000 K EM	IND33W30EM	4058075109520	34	3800	110	70	60.000	50.000	IK06	1199 x 120x 40
NEW	LN INDV D 1200 34 W 4000 K EM	IND33W40EM	4058075109544	34	4200	120	70	60.000	50.000	IK06	1199 x 120x 40
NEW	LN INDV D 1500 25 W 3000 K EM	IND25W30EM	4058075109568	25	3100	125	70	60.000	50.000	IK06	1488 x 120x 40
NEW	LN INDV D 1500 25 W 4000 K EM	IND25W40EM	4058075109582	25	3300	125	70	60.000	50.000	IK06	1488 x 120x 40
NEW	LN INDV D 1500 48 W 3000 K EM	IND50W30EM	4058075109803	48	5300	110	70	60.000	50.000	IK06	1488 x 120x 40
NEW	LN INDV D 1500 48 W 4000 K EM	IND50W40EM	4058075109827	48	5700	120	70	60.000	50.000	IK06	1488 x 120x 40

- Homogenous light distribution and reduced glare thanks to the IndiviLED optics
- Emergency lighting according to IEC 60598-2-22 with emergency lighting driver and battery
- Low flicker light thanks to special electronic control gear
- Multiple mounting options
- Energy savings of up to 50% compared to T5 batten luminaires
- Further variants with DALI ECG, sensor or through wiring additionally available



## LINEAR IndiviLED DIRECT THROUGH-WIRED



Product name	Static Code	GTIN (EAN)	W	lm	lm/W	$\Delta$	L70 <sup>2</sup>	L80 <sup>2</sup>	IK	L x W x H [mm] Ø x H [mm]
--------------	-------------	------------	---	----	------	----------	------------------	------------------	----	------------------------------

## LINEAR IndiviLED® DIRECT THROUGH-WIRED

NEW	LN INDV D 1200 34 W 3000 K TH	INDTH33W30	4058075109087	34	3800	110	70	60.000	50.000	IK06	1199 x 120x 40
NEW	LN INDV D 1200 34 W 4000 K TH	INDTH33W40	4058075109100	34	4200	120	70	60.000	50.000	IK06	1199 x 120x 40
NEW	LN INDV D 1500 25 W 3000 K TH	INDTH25W30	4058075109124	25	3100	125	70	60.000	50.000	IK06	1488 x 120x 40
NEW	LN INDV D 1500 25 W 4000 K TH	INDTH25W40	4058075109148	25	3300	125	70	60.000	50.000	IK06	1488 x 120x 40
NEW	LN INDV D 1500 48 W 3000 K TH	INDTH50W30	4058075109162	48	5300	110	70	60.000	50.000	IK06	1488 x 120x 40
NEW	LN INDV D 1500 48 W 4000 K TH	INDTH50W40	4058075109186	48	5700	120	70	60.000	50.000	IK06	1488 x 120x 40

- Homogenous light distribution and reduced glare thanks to the IndiviLED optics
- Convenient installation of light lines due to pre-assembled through wiring kit
- Multiple mounting options
- Low flicker light thanks to special electronic control gear
- Energy savings of up to 50% compared to T5 batten luminaires
- Robust structure with IK06

<sup>1</sup> The exact terms and conditions can be found at [www.ledvance.co.uk/guarantee](http://www.ledvance.co.uk/guarantee) | <sup>2</sup> t[h]: L70/B50 @ 25°C (T<sub>a</sub>) / t[h]: L80/B10 @ 25°C (T<sub>a</sub>)



1 2 3 4

## LINEAR IndiviLED® ACCESSORIES

LEDVANCE  
2 year guarantee

Product name	Static Code	GTIN (EAN)	L x W x H [mm] Ø x H [mm]	No.
<b>LINEAR IndiviLED® SUSPENSION KIT</b>				
<b>NEW</b> LN INDV Suspension Kit	INSUSKIT	4058075133280	100x25	1
<b>LINEAR IndiviLED® DALI SUSPENSION KIT</b>				
<b>NEW</b> LN INDV DALI Suspension Kit	INSUSDAKIT	4058075133303	100x25	1
<b>LINEAR IndiviLED® SUSPENSION WIRE</b>				
<b>NEW</b> LN INDV Suspension Wire	INSUSWIRE	4058075133327	1610x1x1	2
<b>LINEAR IndiviLED® LIGHT LINE CONNECTOR</b>				
<b>NEW</b> LN INDV Lightline Connector	INLINECON	4058075133341	82x40x12	3
<b>LINEAR IndiviLED® THROUGH-WIRING KIT</b>				
<b>NEW</b> LN INDV 1200 Through Wiring Kit	INTW4KIT	4058075158030	32x20x7	4
<b>NEW</b> LN INDV 1500 Through Wiring Kit	INTW5KIT	4058075133365	32x20x7	4
<b>NEW</b> LN INDV DALI 1200 Through Wiring Kit	INTW4KITDA	4058075158016	32x13x7	4
<b>NEW</b> LN INDV DALI 1500 Through Wiring Kit	INTW5KITDA	4058075157996	32x13x7	4

- Complete suspension kit for easy and quick mounting of one luminaire
- Wire length adjustable thanks to quick-release clamp



## LINEAR ULTRA OUTPUT



LEDVANCE  
5 year guarantee

Product name	Static Code	GTIN (EAN)	W	lm	lm/W	△	L70 <sup>2</sup>	L80 <sup>2</sup>	IK	L x W x H [mm] Ø x H [mm]
<b>LINEAR ULTRA OUTPUT</b>										
<b>NEW</b> LN UO 1200 33 W 3000 K	LU02X430	4058075122147	33	3700	110	110	50.000	40.000	IK08	1168x62x74
<b>NEW</b> LN UO 1200 33 W 4000 K	LU02X440	4058075122161	33	4000	120	110	50.000	40.000	IK08	1168x62x74
<b>NEW</b> LN UO 1500 30 W 3000 K	LU01X530	4058075122185	30	3500	115	110	50.000	40.000	IK08	1458x62x74
<b>NEW</b> LN UO 1500 30 W 4000 K	LU01X540	4058075122208	30	3800	125	110	50.000	40.000	IK08	1458x62x74
<b>NEW</b> LN UO 1500 46 W 3000 K	LU02X530	4058075122222	46	5000	110	110	50.000	40.000	IK08	1458x62x74
<b>NEW</b> LN UO 1500 46 W 4000 K	LU02X540	4058075122246	46	5500	120	110	50.000	40.000	IK08	1458x62x74
<b>NEW</b> LN UO 1500 60 W 3000 K	LU02X8030	4058075122260	60	6600	110	110	50.000	40.000	IK08	1458x62x74
<b>NEW</b> LN UO 1500 60 W 4000 K	LU02X8040	4058075122284	60	7100	120	110	50.000	40.000	IK08	1458x62x74

- Replacement of conventional T8 luminaires with up to 7100 lm
- Energy savings up to 60% (Compared to luminaires that use fluorescent lamps)
- Robust structure with IK08
- Optional reflector accessory and multiple wiring possibilities for flexible applications

<sup>1</sup> The exact terms and conditions can be found at [www.ledvance.co.uk/guarantee](http://www.ledvance.co.uk/guarantee) | <sup>2</sup> t[h]: L70/B50 @ 25°C (T<sub>a</sub>) / t[h]: L80/B10 @ 25°C (T<sub>a</sub>)



# OUR CHECKLIST FOR YOUR LINEAR INDIVILED® DIRECT SYSTEM

**Typical installation:** We have put together for you all the necessary components for typical surface mounting of four luminaires as strip lighting. For more information see the operating instructions for Linear IndiviLED® Direct

**UP TO 20 LUMINAIRES!**

## INSTALLATION OF 4 × LINEAR INDIVILED® DIRECT

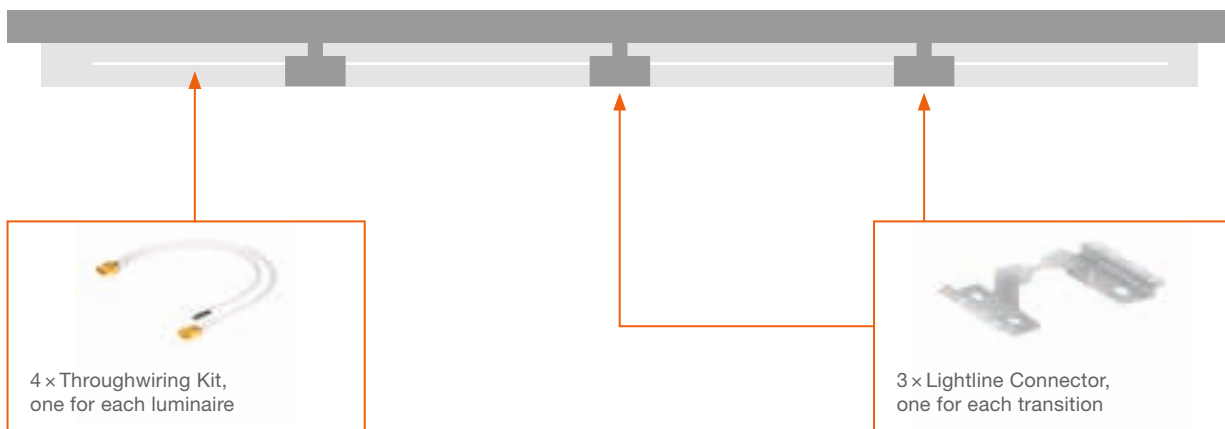

The through-wiring must be fitted by an installer.

### ORDER LIST

- 4 × Linear IndiviLED® Direct
- 4 × Throughwiring Kit
- 3 × Lightline Connector





## LINEAR ULTRA OUTPUT ACCESSORIES

LEDVANCE  
**2** year  
guarantee

Product name	Static Code	GTIN (EAN)		L x W x H [mm] Ø x H [mm]
<b>NEW</b> LINEAR ULTRA OUTPUT ACCESSORIES LN UO 1500 REFLECTOR	LU05REF	4058075133389	80	1420x66x20







- Symmetric and asymmetric light distribution possible with one reflector
- Allows a symmetric light distribution with beam angle 80°



## LINEAR COMPACT SWITCH



LEDVANCE  
**5** year  
guarantee

Product name	Static Code	GTIN (EAN)								L x W x H [mm] Ø x H [mm]
<b>NEW</b> LINEAR COMPACT SWITCH LN COMP SWITCH 300 4 W 3000 K	LBSW130	4058075106079	4	400	100	140	50.000	40.000	IK03	313x28x36
<b>NEW</b> LN COMP SWITCH 300 4 W 4000 K	LBSW140	4058075106093	4	450	110	140	50.000	40.000	IK03	313x28x36
<b>NEW</b> LN COMP SWITCH 600 8 W 3000 K	LBSW230	4058075106116	8	800	100	140	50.000	40.000	IK03	573x28x36
<b>NEW</b> LN COMP SWITCH 600 8 W 4000 K	LBSW240	4058075106130	8	800	100	140	50.000	40.000	IK03	573x28x36
<b>NEW</b> LN COMP SWITCH 900 12 W 3000 K	LBSW330	4058075106192	12	1200	100	140	50.000	40.000	IK03	873x28x36
<b>NEW</b> LN COMP SWITCH 900 12 W 4000 K	LBSW340	4058075106215	12	1200	100	140	50.000	40.000	IK03	873x28x36
<b>NEW</b> LN COMP SWITCH 1200 14 W 3000 K	LBSW430	4058075106154	14	1400	100	140	50.000	40.000	IK03	1173x28x36
<b>NEW</b> LN COMP SWITCH 1200 14 W 4000 K	LBSW440	4058075106178	14	1500	100	140	50.000	40.000	IK03	1173x28x36

- Compact dimensions
- Little space required thanks to compact dimensions
- Seamless connection of up to 10 luminaires in a line
- Handy switch directly installed on the luminaire
- Low flicker light thanks to special electronic control gear
- Flexible installation in 2 different angles with 2 different mounting options

<sup>1</sup> The exact terms and conditions can be found at [www.ledvance.co.uk/guarantee](http://www.ledvance.co.uk/guarantee) | <sup>2</sup> t[h]: L70/B50 @ 25°C (T<sub>a</sub>) / t[h]: L80/B10 @ 25°C (T<sub>a</sub>)



## LINEAR COMPACT HIGH OUTPUT



Product name	Static Code	GTIN (EAN)	W	lm	lm/W	$\theta$	L70 <sup>2</sup>	L80 <sup>2</sup>	IK	L x W x H [mm] Ø x H [mm]
--------------	-------------	------------	---	----	------	----------	------------------	------------------	----	------------------------------

### LINEAR COMPACT HIGH OUTPUT

NEW	LN COMP HO 600 10 W 3000 K	LCBH0230	4058075106277	10	1000	100	140	50.000	40.000	IK03	573 x 24 x 36
NEW	LN COMP HO 600 10 W 4000 K	LCBH0240	4058075106291	10	1000	100	140	50.000	40.000	IK03	573 x 24 x 36
NEW	LN COMP HO 900 15 W 3000 K	LCBH0330	4058075106239	15	1500	100	140	50.000	40.000	IK03	873 x 24 x 36
NEW	LN COMP HO 900 15 W 4000 K	LCBH0340	4058075106253	15	1500	100	140	50.000	40.000	IK03	873 x 24 x 36
NEW	LN COMP HO 1200 20 W 3000 K	LCBH0430	4058075106314	20	2000	100	140	50.000	40.000	IK03	1173 x 24 x 36
NEW	LN COMP HO 1200 20 W 4000 K	LCBH0440	4058075106338	20	2000	100	140	50.000	40.000	IK03	1173 x 24 x 36
NEW	LN COMP HO 1500 25 W 3000 K	LCBH0530	4058075106352	25	2500	100	140	50.000	40.000	IK03	1473 x 24 x 36
NEW	LN COMP HO 1500 25 W 4000 K	LCBH0540	4058075106376	25	2500	100	140	50.000	40.000	IK03	1473 x 24 x 36

- Compact dimensions
- Little space required thanks to compact dimensions
- Seamless connection of up to 10 luminaires in a row
- High lumen output up to 2500 lm
- Seamless connection without visible cables when connected to Linear Compact Batten
- Low flicker light thanks to special electronic control gear



## LINEAR COMPACT BATTEN



Product name	Static Code	GTIN (EAN)	W	lm	lm/W	$\theta$	L70 <sup>2</sup>	L80 <sup>2</sup>	IK	L x W x H [mm] Ø x H [mm]
--------------	-------------	------------	---	----	------	----------	------------------	------------------	----	------------------------------

### LINEAR COMPACT BATTEN





NEW	LN COMP Batten 600 10 W 3000 K	LCB230	4058075099692	10	1000	100	140	50.000	40.000	IK03	575 x 27 x 38
NEW	LN COMP Batten 600 10 W 4000 K	LCB240	4058075099715	10	1000	100	140	50.000	40.000	IK03	575 x 27 x 38
NEW	LN COMP Batten 1200 20 W 3000 K	LCB430	4058075099739	20	2000	100	140	50.000	40.000	IK03	1175 x 27 x 38
NEW	LN COMP Batten 1200 20 W 4000 K	LC1440	4058075099753	20	2000	100	140	50.000	40.000	IK03	1175 x 27 x 38
NEW	LN COMP Batten 1500 25 W 3000 K	LCB530	4058075099777	25	2500	100	140	50.000	40.000	IK03	1475 x 27 x 38
NEW	LN COMP Batten 1500 25 W 4000 K	LCB540	4058075099791	25	2500	100	140	50.000	40.000	IK03	1475 x 27 x 38

- Compact dimensions
- Little space required thanks to compact dimensions
- Seamless connection without visible cables when connected to Linear Compact High Output
- High lumen output up to 2500 lm
- Flexible application due to a wide range of available lengths of 600 to 1500 mm
- Low flicker light thanks to special electronic control gear

<sup>1</sup> The exact terms and conditions can be found at [www.ledvance.co.uk/guarantee](http://www.ledvance.co.uk/guarantee) | <sup>2</sup> t[h]: L70/B50 @ 25°C (T<sub>a</sub>) / t[h]: L80/B10 @ 25°C (T<sub>a</sub>)

# TRUNKING SYSTEMS

## COMPARISON BETWEEN TRUSYS® AND TRUSYS® PERFORMANCE

TRUSYS®	TRUSYS® PERFORMANCE	
 	 	
Shop lighting, discounters, DIY stores	← Applications →	Warehouses, industrial applications, factories, workshops
3000, 4000 und 6500K	← Available light colours →	4000K
Up to 7,200 lm	← Available lumen values →	5,600, 8,000, 11,200 lm
High-quality attractive SCALE design, anodized aluminium housing	← Design →	Practical, simple and functional design, white housing
Beam angle for optimum illumination of merchandise in shops	← Beam angle →	Beam angle for optimum illumination of warehouses and factories
Wide (W), narrow (NFL), asymmetric (WW), double asymmetric (DA)	← Distribution of light →	Very wide (VW): 120°, wide (W): 90°, narrow (N): 60°, very narrow (VN): 30°

For more detailed information about the TruSys® and TruSys® Performance systems see the system data sheet at [www.ledvance.co.uk/professional](http://www.ledvance.co.uk/professional)



## TruSys® PERFORMANCE



Product name	Static Code	GTIN (EAN)	W	lm	lm/W	°	L70 <sup>2</sup>	L80 <sup>2</sup>	IK	L x W x H [mm] Ø x H [mm]
--------------	-------------	------------	---	----	------	---	------------------	------------------	----	------------------------------

TruSys® PERFORMANCE VERY WIDE											
NEW	TruSys PFM VW 35 W 4000 K	TP3540W	4058075290921	35	5600	160	120	65.000	60.000	IK04	1500x67x39
TruSys® PERFORMANCE WIDE											
NEW	TruSys PFM W 35 W 4000 K	TP3540W	4058075290839	35	5600	160	90	65.000	60.000	IK04	1500x67x39
NEW	TruSys PFM W 50 W 4000 K	TP5040W	4058075290853	50	8000	160	90	65.000	60.000	IK04	1500x67x39
NEW	TruSys PFM W 70 W 4000 K	TP7040W	4058075290891	70	11200	160	90	55.000	50.000	IK04	1500x67x39
TruSys® PERFORMANCE NARROW											
NEW	TruSys PFM N 50 W 4000 K	TP5040N	4058075290945	50	8000	160	60	65.000	60.000	IK04	1500x67x39
NEW	TruSys PFM N 70 W 4000 K	TP7040N	4058075290969	70	11200	160	60	55.000	50.000	IK04	1500x67x39
TruSys® PERFORMANCE VERY NARROW											
NEW	TruSys PFM VN 70 W 4000 K	TP7040VN	4058075290983	70	11200	160	30	55.000	50.000	IK04	1500x67x39

- Very wide light distribution for area lighting
- Easy installation, no tools required for connection
- Energy saving and cost-effective
- Flexible application due to a range of different lumen packages
- Rows of up to 57 luminaires possible

<sup>1</sup> The exact terms and conditions can be found at [www.ledvance.co.uk/guarantee](http://www.ledvance.co.uk/guarantee) | <sup>2</sup> t[h]: L70/B50 @ 25°C (T<sub>a</sub>) / t[h]: L80/B10 @ 25°C (T<sub>a</sub>)



## TruSys® PERFORMANCE DALI



Product name	Static Code	GTIN (EAN)	W	lm	lm/W	°	L70 <sup>2</sup>	L80 <sup>2</sup>	IK	L x W x H [mm] Ø x H [mm]	
<b>TruSys® PERFORMANCE DALI VERY WIDE</b>											
NEW TruSys PFM DALI VW 35 W 4000 K	TP3540WDA	4058075291072	35	5600	160	120	65.000	60.000	IK04	1500x67x39	✓
<b>TruSys® PERFORMANCE DALI WIDE</b>											
NEW TruSys PFM DALI W 35 W 4000 K	TP3540WDA	4058075291010	35	5600	160	90	65.000	60.000	IK04	1500x67x39	✓
NEW TruSys PFM DALI W 50 W 4000 K	TP50WDA	4058075291034	50	8000	160	90	65.000	60.000	IK04	1500x67x39	✓
NEW TruSys PFM DALI W 70 W 4000 K	TP7040WDA	4058075291058	70	11200	160	90	55.000	50.000	IK04	1500x67x39	✓
<b>TruSys® PERFORMANCE DALI NARROW</b>											
NEW TruSys PFM DALI N 50 W 4000 K	TP5040NDA	4058075291096	50	8000	160	60	65.000	60.000	IK04	1500x67x39	✓
NEW TruSys PFM DALI N 70 W 4000 K	TP7040NDA	4058075291119	70	11200	160	60	55.000	50.000	IK04	1500x67x39	✓
<b>TruSys® PERFORMANCE DALI VERY NARROW</b>											
NEW TruSys PFM DALI VN 70 W 4000 K	TP7040VNDA	4058075291133	70	11200	160	30	55.000	50.000	IK04	1500x67x39	✓

- Advanced functionality due to external DALI driver
- Very wide light distribution for area lighting
- Easy installation, no tools required for connection
- Energy saving and cost-effective
- Flexible application due to a range of different lumen packages
- Rows of up to 66 luminaires possible

<sup>1</sup> The exact terms and conditions can be found at [www.ledvance.co.uk/guarantee](http://www.ledvance.co.uk/guarantee) | <sup>2</sup> t[h]: L70/B50 @ 25°C (T<sub>a</sub>) / t[h]: L80/B10 @ 25°C (T<sub>a</sub>)



## TruSys® PERFORMANCE ENERGY RAIL

LEDVANCE  
**2**  
year  
guarantee

Product name	Static Code	GTIN (EAN)	L x W x H [mm] Ø x H [mm]
<b>TruSys® PERFORMANCE ENERGY RAIL 5 POLE</b>			
<b>NEW</b> TruSys PFM ENERGY RAIL 5P 1500	TPER5150010X	4058075 <b>299443</b>	1650 x 70x 39
<b>NEW</b> TruSys PFM ENERGY RAIL 5P 1500	TPER515001X	4058075 <b>299566</b>	1650 x 70x 39
<b>NEW</b> TruSys PFM ENERGY RAIL 5P 1500 END	TPER51500E10X	4058075 <b>299474</b>	1500 x 70x 39
<b>NEW</b> TruSys PFM ENERGY RAIL 5P 1500 END	TPER51500E1X	4058075 <b>354753</b>	1500 x 70x 39
<b>NEW</b> TruSys PFM ENERGY RAIL 5P 3000	TPER5300010X	4058075 <b>299498</b>	3150 x 70x 39
<b>NEW</b> TruSys PFM ENERGY RAIL 5P 3000	TPER530001X	4058075 <b>354777</b>	3150 x 70x 39
<b>TruSys® PERFORMANCE ENERGY RAIL 8 POLE</b>			
<b>NEW</b> TruSys PFM ENERGY RAIL 8P 1500	TPER8150010X	4058075 <b>299504</b>	1650 x 70x 39
<b>NEW</b> TruSys PFM ENERGY RAIL 8P 1500	TPER815001X	4058075 <b>299573</b>	1650 x 70x 39
<b>NEW</b> TruSys PFM ENERGY RAIL 8P 1500 END	TPER8150010X	4058075 <b>299559</b>	1500 x 70x 39
<b>NEW</b> TruSys PFM ENERGY RAIL 8P 1500 END	TPER815001X	4058075 <b>354760</b>	1500 x 70x 39
<b>NEW</b> TruSys PFM ENERGY RAIL 8P 3000	TPER300010X	4058075 <b>299450</b>	3150 x 70x 39
<b>NEW</b> TruSys PFM ENERGY RAIL 8P 3000	TPER30001X	4058075 <b>354784</b>	3150 x 70x 39

- Simple installation
- High flexibility thanks to two available lengths (1500mm, 3000mm and 1500mm end rail)

<sup>1</sup> The exact terms and conditions can be found at [www.ledvance.co.uk/guarantee](http://www.ledvance.co.uk/guarantee)



## TruSys® PERFORMANCE ACCESSORIES

LEDVANCE  
**2** year  
guarantee

Product name	Static Code	GTIN (EAN)	L x W x H [mm] Ø x H [mm]	 No.
<b>TruSys® PERFORMANCE Suspension Kit</b>				
<b>NEW</b> TruSys PFM Suspension Kit	TPSUS	4058075284234	57 x 35x 65	1
<b>TruSys® PERFORMANCE Chain Kit</b>				
<b>NEW</b> TruSys PFM Chain Kit	TPCK	4058075284258	90 x 28x 10	2
<b>TruSys® PERFORMANCE Blind Cover</b>				
<b>NEW</b> TruSys PFM Blind Cover	TPBC	4058075284296	1500 x 73x 20	3
<b>TruSys® PERFORMANCE End Cap Energy Rail</b>				
<b>NEW</b> TruSys PFM End Cap Energy Rail	TPREND	4058075284319	78 x 72x 13	4
<b>TruSys® PERFORMANCE Surface Clip</b>				
<b>NEW</b> TruSys PFM Surface Clip	TPSURCLIP	4058075284333	57 x 35x 18	5
<b>TruSys® PERFORMANCE Grid Ceiling Clip</b>				
<b>NEW</b> TruSys PFM Grid Ceiling Clip	TPGRID	4058075284609	57 x 35x 26	6
<b>TruSys® PERFORMANCE Feed-In</b>				
<b>NEW</b> TruSys PFM Feed-in 5P	TPFEED5	4058075284623	85 x 55x 15	7
<b>NEW</b> TruSys PFM Feed-in 8P	TPFEED8	4058075284647	85 x 55x 15	7
<b>NEW</b> TruSys PFM Feed-in 12P	TPFEED12	4058075284661	85 x 55x 15	7

<sup>1</sup> The exact terms and conditions can be found at [www.ledvance.co.uk/guarantee](http://www.ledvance.co.uk/guarantee)



# OUR CHECKLIST FOR YOUR PERFECT TRUSYS® SOLUTION

**Typical installation:** So you can install a tailor-made TruSys® lighting system for your customers we have put together a summary of the components you'll need for individual luminaires or strip lighting. With appropriate accessories depending on the type of mounting (surface or suspended). For simple strip lighting the mechanical and electrical connectors are already integrated in the trunking.

## TRUSYS® INSTALLATION ❶ WITHOUT AND ❷ WITH BLIND COVER

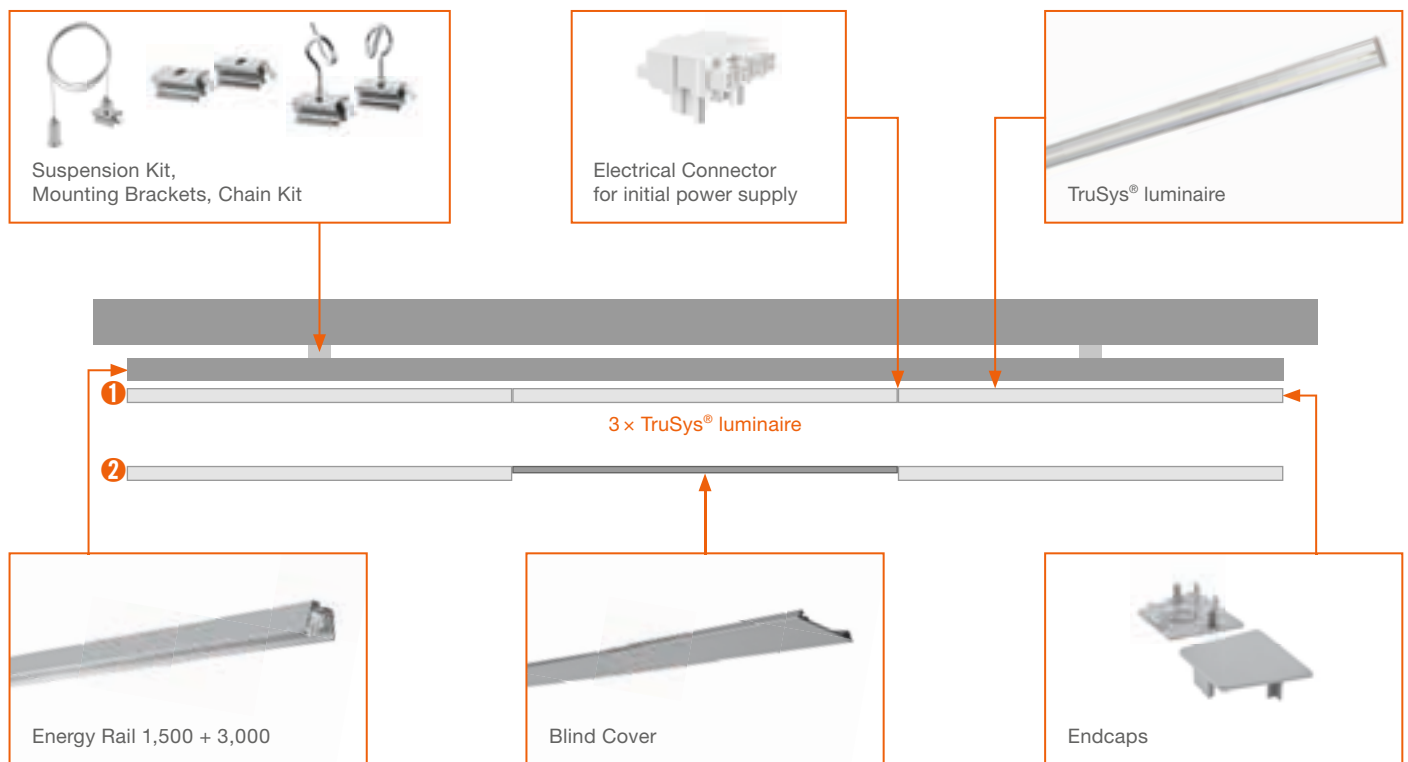

For more information on installation and components see the operating instructions for the relevant TruSys® model.

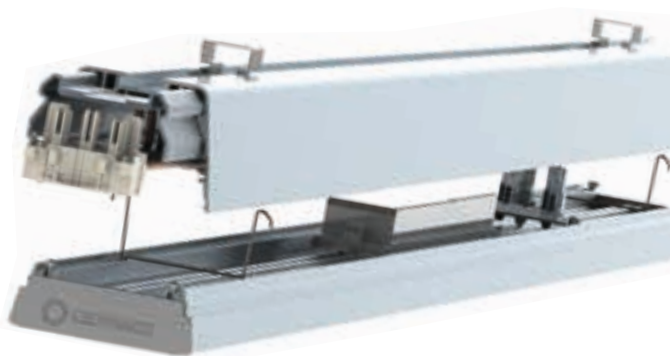

### FOR INSTALLATION YOU WILL NEED:



- 1 x TruSys® Electrical Connector (5 x 2.5 or 7 x 2.5)
- X x TruSys® Energy Rail
- X x TruSys® LED luminaire (TruSys® Blind Cover as required)
- X x Accessories depending on type of mounting (surface or suspended)
- 1 x Set TruSys® Endcap Energy Rail



## TruSys



Product name	Static Code	GTIN (EAN)	W	lm	lm/W		L70 <sup>2</sup>	L80 <sup>2</sup>	IK	L x W x H [mm] Ø x H [mm]
<b>TruSys® WIDE</b>										
NEW TruSys W 53 W 3000 K SI	TAT030W	4058075100459	53	6600	125	105	75.000	50.000	IK07	1534 x 71 x 53
NEW TruSys W 53 W 4000 K SI	TAT040W	4058075100473	53	7200	135	105	75.000	50.000	IK07	1534 x 71 x 53
NEW TruSys W 53 W 6500 K SI	TAT065W	4058075100497	53	6900	130	105	75.000	50.000	IK07	1534 x 71 x 53
<b>TruSys® NARROW</b>										
NEW TruSys NFL 53 W 3000 K SI	TAT030N	4058075100510	53	6200	115	25	75.000	50.000	IK07	1534 x 71 x 53
NEW TruSys NFL 53 W 4000 K SI	TAT040N	4058075100534	53	6700	125	25	75.000	50.000	IK07	1534 x 71 x 53
NEW TruSys NFL 53 W 6500 K SI	TAT065N	4058075100558	53	6500	125	25	75.000	50.000	IK07	1534 x 71 x 53
<b>TruSys® WALLWASHER</b>										
NEW TruSys WW 53 W 3000 K SI	TAT030WW	4058075100572	53	5700	110	45	75.000	50.000	IK07	1534 x 71 x 53
NEW TruSys WW 53 W 4000 K SI	TAT040WW	4058075100596	53	6300	120	45	75.000	50.000	IK07	1534 x 71 x 53
NEW TruSys WW 53 W 6500 K SI	TAT065WW	4058075100619	53	6100	115	45	75.000	50.000	IK07	1534 x 71 x 53
<b>TruSys® DOUBLE ASYMMETRIC</b>										
NEW TruSys DA 53 W 3000 K SI	TAT030SH	4058075100633	53	6400	120	2 x 35	75.000	50.000	IK07	1534 x 71 x 53
NEW TruSys DA 53 W 4000 K SI	TAT040SH	4058075100657	53	6900	130	2 x 35	75.000	50.000	IK07	1534 x 71 x 53
NEW TruSys DA 53 W 6500 K SI	TAT065SH	4058075100671	53	6700	125	2 x 35	75.000	50.000	IK07	1534 x 71 x 53

- Innovative optical design with a rod lense-technology over the entire length of the luminaire
- Internal holders prevent the luminaire from falling while being mounted
- Easy electrical and mechanical connection to the mounting rail via snap-in mounting
- Homogenous light distribution
- Clean look as mouting brackets are not visible when mounted
- Plug-and-play system allows easy installation

<sup>1</sup> The exact terms and conditions can be found at [www.ledvance.co.uk/guarantee](http://www.ledvance.co.uk/guarantee) | <sup>2</sup> t[h]: L70/B50 @ 25°C (T<sub>a</sub>) / t[h]: L80/B10 @ 25°C (T<sub>a</sub>)



## TruSys DALI



Product name

Static Code

GTIN (EAN)

L x W x H [mm]  
Ø x H [mm]

TruSys® DALI WIDE												
NEW	TruSys DALI W 53 W 3000 K SI	TDALI30W	4058075102460	53	6600	125	105	75.000	50.000	IK07	1534x71x53	✓
NEW	TruSys DALI W 53 W 4000 K SI	TDALI40W	4058075102484	53	7200	135	105	75.000	50.000	IK07	1534x71x53	✓
NEW	TruSys DALI W 53 W 6500 K SI	TDALI65W	4058075102507	53	6900	130	105	75.000	50.000	IK07	1534x71x53	✓
TruSys® DALI NARROW												
NEW	TruSys DALI NFL 53 W 3000 K SI	TDALI30N	4058075102521	53	6200	115	25	75.000	50.000	IK07	1534x71x53	✓
NEW	TruSys DALI NFL 53 W 4000 K SI	TDALI40N	4058075102545	53	6700	125	25	75.000	50.000	IK07	1534x71x53	✓
NEW	TruSys DALI NFL 53 W 6500 K SI	TDALI65N	4058075102569	53	6500	125	25	75.000	50.000	IK07	1534x71x53	✓
TruSys® DALI WALLWASHER												
NEW	TruSys DALI WW 53 W 3000 K SI	TDALI30WW	4058075102583	53	5700	110	45	75.000	50.000	IK07	1534x71x53	✓
NEW	TruSys DALI WW 53 W 4000 K SI	TDALI40WW	4058075102606	53	6300	120	45	75.000	50.000	IK07	1534x71x53	✓
NEW	TruSys DALI WW 53 W 6500 K SI	TADLI65WW	4058075102620	53	6100	115	45	75.000	50.000	IK07	1534x71x53	✓
TruSys® DALI DOUBLE ASYMMETRIC												
NEW	TruSys DALI DA 53 W 3000 K SI	TDALI30SH	4058075102644	53	6400	120	2 x 35	75.000	50.000	IK07	1534x71x53	✓
NEW	TruSys DALI DA 53 W 4000 K SI	TDALI40SH	4058075102668	53	6900	130	2 x 35	75.000	50.000	IK07	1534x71x53	✓
NEW	TruSys DALI DA 53 W 6500 K SI	TDALI65SH	4058075102682	53	6700	125	2 x 35	75.000	50.000	IK07	1534x71x53	✓

- Innovative optical design with a rod lense-technology over the entire length of the luminaire
- Internal holders prevent the luminaire from falling while being mounted
- Easy electrical and mechanical connection to the mounting rail via snap-in mounting
- Homogenous light distribution
- Clean look as mouting brackets are not visible when mounted
- Plug-and-play system allows easy installation

<sup>1</sup> The exact terms and conditions can be found at [www.ledvance.co.uk/guarantee](http://www.ledvance.co.uk/guarantee) | <sup>2</sup> t[h]: L70/B50 @ 25°C (T<sub>a</sub>) / t[h]: L80/B10 @ 25°C (T<sub>a</sub>)



## TruSys ENERGY RAIL

IP 20

LEDVANCE  
2 year  
guarantee

Product name	Static Code	GTIN (EAN)	L x W x H [mm] Ø x H [mm]
<b>TruSys® ENERGY RAIL</b>			
<b>NEW</b> TruSys ENERGY RAIL 1500 5X2,5	TER1500	4058075100299	1535 x 67 x 44
<b>NEW</b> TruSys ENERGY RAIL 3000 5X2,5	TER3000	4058075100312	3070 x 67 x 44
<b>NEW</b> TruSys ENERGY RAIL 4500 5X2,5	TER4500	4058075100336	4605 x 67 x 44
<b>TruSys® ENERGY RAIL DALI</b>			
<b>NEW</b> TruSys ENERGY RAIL DALI 1500 7X2,5	TER1500	4058075103450	1535 x 67 x 44
<b>NEW</b> TruSys ENERGY RAIL DALI 3000 7X2,5	TER3000	4058075103474	3068 x 67 x 44
<b>NEW</b> TruSys ENERGY RAIL DALI 4500 7X2,5	TER4500	4058075103498	4601 x 67 x 44

- Simple installation
- High flexibility thanks to three available lengths (1500mm, 3000mm, 4500mm)
- High-value design
- Lightweight design



## TruSys® ACCESSORIES

LEDVANCE  
2 year  
guarantee

Product name	Static Code	GTIN (EAN)	L x W x H [mm] Ø x H [mm]	Light No.
<b>TruSys® END CAP ENERGY RAIL</b>				
<b>NEW</b> TruSys End Cap Energy Rail	TEND	4058075100411	12 x 67 x 47	1
<b>TruSys® SUSPENSION KIT</b>				
<b>NEW</b> TruSys Suspension Kit	TSK3000	4058075100350	3000 x - x -	2
<b>TruSys® MOUNTING BRACKETS</b>				
<b>NEW</b> TruSys Mounting Brackets	TMBKT	4058075100435	30 x 20 x 15	3
<b>TruSys® CHAIN KIT</b>				
<b>NEW</b> TruSys Chain Kit	TCK	4058075100374	44 x 40 x 55	4
<b>TruSys® BLIND COVER</b>				
<b>NEW</b> TruSys Blind Cover	TBC1500	4058075100398	1534 x 67 x 12	5
<b>TruSys® ELECTRICAL CONNECTOR</b>				
<b>NEW</b> TruSys Electrical Connector	TELECON5	4058075155565	42 x 41 x 29	6
<b>TruSys® ELECTRICAL CONNECTOR DALI</b>				
<b>NEW</b> TruSys Electrical Connector DALI	TELECON7	4058075155589	42 x 41 x 29	6

- Simple snap-in mounting of end caps

<sup>1</sup> The exact terms and conditions can be found at [www.ledvance.co.uk/guarantee](http://www.ledvance.co.uk/guarantee)



# DAMP PROOF LUMINAIRES

## INSTALLATION MADE EASY: DAMP PROOF COMPACT FROM LEDVANCE

**NEW**

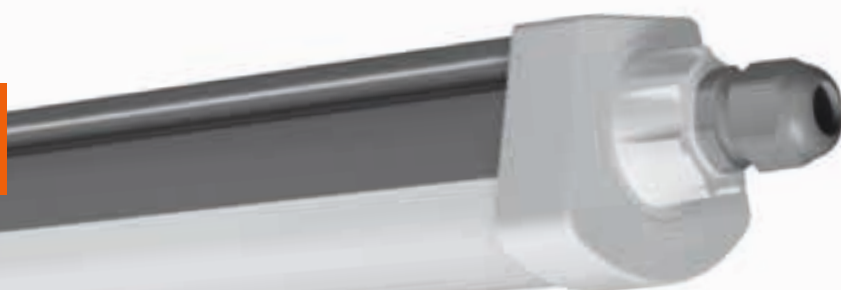

### INSTALLATION IN NO TIME AT ALL

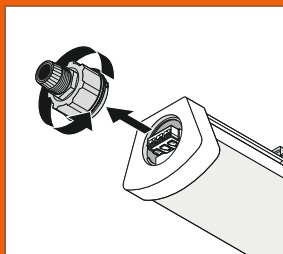
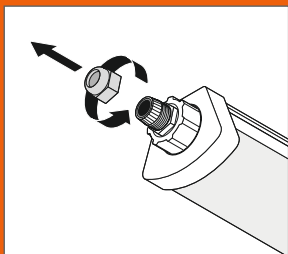
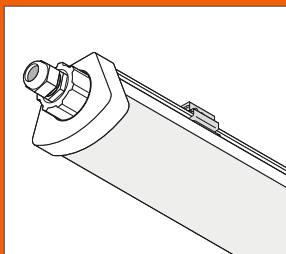

The end caps with their “Twist & Lock” mechanism allow for quick tool-free electrical connection.

### THROUGH-WIRING OF DAMP PROOF LUMINAIRES AT A GLANCE

	One-sided connection	3 × 1.5 mm <sup>2</sup> Through-wiring preinstalled	5 × 2.5 mm <sup>2</sup> Through-wiring preinstalled	DALI	Emergency lighting function
DP Special		✓			
DP Compact		✓			
DP Slim Value	✓				
DP	✓	Through-wiring possible*	39 W 4000 K 55 W 4000 K	✓	✓
DP Value	✓	Through-wiring possible*	Through-wiring possible*		
DP Housing	✓	Through-wiring possible*	Through-wiring possible*		

\* The product is technically equipped for through-wiring. In some cases, additional accessories are required. Please refer to the operating instructions.



## DAMP PROOF COMPACT IP66



Product name	Static Code	GTIN (EAN)	W	lm	lm/W		L70 <sup>2</sup>	L80 <sup>2</sup>	IK	L x W x H [mm] Ø x H [mm]
--------------	-------------	------------	---	----	------	--	------------------	------------------	----	------------------------------

## DAMP PROOF COMPACT IP66

NEW	DP COMPACT 1200 23 W 4000K IP66 GY	DPC1440	4058075210028	23	2800	120	120	50.000	35.000	IK08	1290 x 86x 68
NEW	DP COMPACT 1200 44 W 4000K IP66 GY	DPC2440	4058075210042	44	5400	120	120	50.000	35.000	IK08	1290 x 86x 68
NEW	DP COMPACT 1200 44 W 6500K IP66 GY	DPC2465	4058075210066	44	5400	120	120	50.000	35.000	IK08	1290 x 86x 68
NEW	DP COMPACT 1500 31 W 4000K IP66 GY	DPC1540	4058075210080	31	3800	120	120	50.000	35.000	IK08	1590 x 86x 68
NEW	DP COMPACT 1500 55 W 4000K IP66 GY	DPC2540	4058075210103	55	6700	120	120	50.000	35.000	IK08	1590 x 86x 68
NEW	DP COMPACT 1500 55 W 6500K IP66 GY	DPC2565	4058075210127	55	6700	120	120	50.000	35.000	IK08	1590 x 86x 68

- Evenly distributed light
- Energy savings of up to 50% (Compared to luminaires that use fluorescent lamps)
- Easy installation as mounting brackets can be positioned freely on the luminaire
- Easy access to electrical terminal thanks end caps with twist and lock mechanism
- Tool-free electrical connection due to push button connector



## DAMP PROOF



Product name	Static Code	GTIN (EAN)	W	lm	lm/W		L70 <sup>2</sup>	L80 <sup>2</sup>	IK	L x W x H [mm] Ø x H [mm]
--------------	-------------	------------	---	----	------	--	------------------	------------------	----	------------------------------

## DAMP PROOF

	DP 1200 21 W 4000K IP65 GY	DP1440	4058075079892	21	2400	115	105	50.000	35.000	IK08	1200 x 95x 78
NEW	DP 1200 21 W 6500 K IP65 GY	DP1465	4058075218024	21	2400	115	105	50.000	35.000	IK08	1200 x 95x 78
	DP 1200 39 W 4000K IP65 GY	DP2440	4058075079915	39	4400	115	105	50.000	35.000	IK08	1200 x 95x 78
	DP 1200 39 W 6500K IP65 GY	DP2465	4058075079854	39	4400	115	105	50.000	35.000	IK08	1200 x 95x 78
	DP 1500 30 W 4000K IP65 GY	DP1540	4058075079939	30	3500	115	105	50.000	35.000	IK08	1500 x 95x 78
NEW	DP 1500 30 W 6500 K IP65 GY	DP1565	4058075218048	30	3500	115	105	50.000	35.000	IK08	1500 x 95x 78
	DP 1500 55 W 4000K IP65 GY	DP2540	4058075079953	55	6400	115	105	50.000	35.000	IK08	1500 x 95x 78
	DP 1500 55 W 6500K IP65 GY	DP2565	4058075079878	55	6400	115	105	50.000	35.000	IK08	1500 x 95x 78

- Evenly distributed light
- Energy savings of up to 50% (Compared to luminaires that use fluorescent lamps)
- Easy installation, no tools required for connection

<sup>1</sup> The exact terms and conditions can be found at [www.ledvance.co.uk/guarantee](http://www.ledvance.co.uk/guarantee) | <sup>2</sup> t[h]: L70/B50 @ 25°C (T<sub>a</sub>) / t[h]: L80/B10 @ 25°C (T<sub>a</sub>)



## DAMP PROOF 5 x THROUGHWIRING



Product name	Static Code	GTIN (EAN)	W	lm	lm/W	°	L70 <sup>2</sup>	L80 <sup>2</sup>	IK	L x W x H [mm] Ø x H [mm]
--------------	-------------	------------	---	----	------	---	------------------	------------------	----	------------------------------

### DAMP PROOF 5x THROUGHWIRING

NEW	DP 5x TH 39 W 4000 K IP65 GY	DPTW2440	4058075319240	39	4400	115	105	50.000	35.000	IK08	1200x95x78
NEW	DP 5x TH 55 W 4000 K IP65 GY	DPTW2540	4058075319325	55	6400	115	105	50.000	35.000	IK08	1500x95x78

- Evenly distributed light
- Energy savings of up to 50% (Compared to luminaires that use fluorescent lamps)
- Easy installation, no tools required for connection



## DAMP PROOF DALI



Product name	Static Code	GTIN (EAN)	W	lm	lm/W	°	L70 <sup>2</sup>	L80 <sup>2</sup>	IK	L x W x H [mm] Ø x H [mm]	
--------------	-------------	------------	---	----	------	---	------------------	------------------	----	------------------------------	--

### DAMP PROOF DALI

NEW	DP DALI 1200 21 W 4000 K IP65 GY	DP1440DA	4058075130913	21	2400	115	105	50.000	35.000	IK08	1200x95x78	✓
NEW	DP DALI 1200 21 W 6500 K IP65 GY	DP1465DA	4058075218062	21	2400	115	105	50.000	35.000	IK08	1200x95x78	✓
NEW	DP DALI 1200 39 W 4000 K IP65 GY	DP2440DA	4058075130937	39	4400	115	105	50.000	35.000	IK08	1200x95x78	✓
NEW	DP DALI 1200 39 W 6500 K IP65 GY	DP2465DA	4058075210141	39	4400	115	105	50.000	35.000	IK08	1200x95x78	✓
NEW	DP DALI 1500 30 W 4000 K IP65 GY	DP1540DA	4058075130975	30	3500	115	105	50.000	35.000	IK08	1500x95x78	✓
NEW	DP DALI 1500 30 W 6500 K IP65 GY	DP1565DA	4058075218086	30	3500	115	105	50.000	35.000	IK08	1500x95x78	✓
NEW	DP DALI 1500 55 W 4000 K IP65 GY	DP2540DA	4058075130999	55	6400	115	105	50.000	35.000	IK08	1500x95x78	✓
NEW	DP DALI 1500 55 W 6500 K IP65 GY	DP2565DA	4058075210165	55	6400	115	105	50.000	35.000	IK08	1500x95x78	✓

- Evenly distributed light
- Energy savings of up to 50% (Compared to luminaires that use fluorescent lamps)
- High compatibility thanks to DALI-2 certification
- Easy installation, no tools required for connection

<sup>1</sup> The exact terms and conditions can be found at [www.ledvance.co.uk/guarantee](http://www.ledvance.co.uk/guarantee) | <sup>2</sup> t[h]: L70/B50 @ 25°C (T<sub>a</sub>) / t[h]: L80/B10 @ 25°C (T<sub>a</sub>)





## DAMP PROOF EMERGENCY

IP65

LEDVANCE  
3  
year  
guarantee

Product name	Static Code	GTIN (EAN)	W	lm	lm/W	°	L70 <sup>2</sup>	L80 <sup>2</sup>	IK	L x W x H [mm] Ø x H [mm]
--------------	-------------	------------	---	----	------	---	------------------	------------------	----	------------------------------

### DAMP PROOF EMERGENCY

NEW	DAMP PROOF EM 1200 21 W 4000 K AT 3H	DP1440EM	4058075203969	21	2400	115	105	50.000	35.000	IK08	1200x95x78
NEW	DAMP PROOF EM 1200 39 W 4000 K AT 3H	DP2440EM	4058075203983	39	4400	115	105	50.000	35.000	IK08	1200x95x78
NEW	DAMP PROOF EM 1200 39 W 6500 K AT 3H	DP2465EM	4058075204003	39	4400	115	105	50.000	35.000	IK08	1200x95x78
NEW	DAMP PROOF EM 1500 30 W 4000 K AT 3H	DP1540EM	4058075204027	30	3500	115	105	50.000	35.000	IK08	1500x95x78
NEW	DAMP PROOF EM 1500 55 W 4000 K AT 3H	DP2540EM	4058075204041	55	6400	115	105	50.000	35.000	IK08	1500x95x78
NEW	DAMP PROOF EM 1500 55 W 6500 K AT 3H	DP2565EM	4058075204065	55	6400	115	105	50.000	35.000	IK08	1500x95x78

- Seamless integration of luminaires with emergency lighting function into general lighting
- Easy wiring thanks to included prewired driver and battery for Emergency lighting function
- Simple testing of luminaires with emergency lighting function thanks to integrated automatic test function
- Convenient visualization of results of automatic test with an included control LED
- Operation of integrated emergency lighting function with long life LiFePO4 battery with 3h battery discharge time
- Evenly distributed light in normal operation



## DAMP PROOF SPECIAL



IP67

LEDVANCE  
5  
year  
guarantee

Product name	Static Code	GTIN (EAN)	W	lm	lm/W	°	L70 <sup>2</sup>	L80 <sup>2</sup>	IK	L x W x H [mm] Ø x H [mm]
--------------	-------------	------------	---	----	------	---	------------------	------------------	----	------------------------------

### DAMP PROOF SPECIAL

NEW	DP SPECIAL 1200 36 W 4000 K IP67 WT	DPS440	4058075136250	36	5400	145	120	100.000	80.000	IK06	72x-
NEW	DP SPECIAL 1500 48 W 4000 K IP67 WT	DPS540	4058075136274	48	7200	145	120	100.000	80.000	IK06	72x-

- Equalization valve allows for use in changing ambient humidity (up to 95%) and temperature
- Evenly distributed light
- Energy savings of up to 50% (Compared to luminaires that use fluorescent lamps)
- Low flicker light thanks to special electronic control gear
- Easy installation as mounting brackets can be positioned freely on the luminaire
- Easy installation, no tools required for connection

<sup>1</sup> The exact terms and conditions can be found at [www.ledvance.co.uk/guarantee](http://www.ledvance.co.uk/guarantee) | <sup>2</sup> t[h]: L70/B50 @ 25°C (T<sub>a</sub>) / t[h]: L80/B10 @ 25°C (T<sub>a</sub>)



## DAMP PROOF SLIM VALUE



Product name	Static Code	GTIN (EAN)	W	lm	lm/W	°	L70 <sup>2</sup>	L80 <sup>2</sup>	IK	L x W x H [mm] Ø x H [mm]
--------------	-------------	------------	---	----	------	---	------------------	------------------	----	------------------------------

DAMP PROOF SLIM VALUE										
DP SLIM VALUE 1200 36 W 4000 K IP65 GY	DPSV440	4058075066458	36	4000	110	120	30.000	27.000	IK08	1200 x 35 x 48
DP SLIM VALUE 1200 36 W 6500 K IP65 GY	DPSV465	4058075066472	36	4000	110	120	30.000	27.000	IK08	1200 x 35 x 48
DP SLIM VALUE 1500 50 W 4000 K IP65 GY	DPSV540	4058075066496	50	5500	110	120	30.000	27.000	IK08	1500 x 35 x 48
DP SLIM VALUE 1500 50 W 6500 K IP65 GY	DPSV565	4058075066519	50	5500	110	120	30.000	27.000	IK08	1500 x 35 x 48

- Evenly distributed light
- Energy savings of up to 50% (Compared to luminaires that use fluorescent lamps)
- Very slim housing
- Easy installation as mounting brackets can be positioned freely on the luminaire
- Tool-free electrical connection due to push button connector
- Easy access to electrical terminal thanks end caps with clip mechanism



## DAMP PROOF VALUE



Product name	Static Code	GTIN (EAN)	W	lm	lm/W	°	L70 <sup>2</sup>	IK	L x W x H [mm] Ø x H [mm]
--------------	-------------	------------	---	----	------	---	------------------	----	------------------------------

DAMP PROOF VALUE									
<b>NEW</b> DP VAL 600 9 W 4000 K IP65	VDP1240	4058075300705	9	1080	120	115	50.000	IK08	600 x 77 x 66
<b>NEW</b> DP VAL 600 18 W 4000 K IP65	VDP2240	4058075300743	18	2160	120	115	50.000	IK08	600 x 77 x 66
<b>NEW</b> DP VAL 1200 20 W 4000 K IP65	VDP1440	4058075300781	20	2400	120	115	50.000	IK08	1200 x 77 x 66
<b>NEW</b> DP VAL 1200 40 W 4000 K IP65	VDP2440	4058075300828	40	4800	120	115	50.000	IK08	1200 x 77 x 66
<b>NEW</b> DP VAL 1500 25 W 4000 K IP65	VDP1540	4058075300866	25	3000	120	115	50.000	IK08	1500 x 77 x 66
<b>NEW</b> DP VAL 1500 50 W 4000 K IP65	VDP2540	4058075300903	50	6000	120	115	50.000	IK08	1500 x 77 x 66

- Evenly distributed light
- Energy savings of up to 50% (Compared to luminaires that use fluorescent lamps)
- Easy installation, no tools required for connection

<sup>1</sup> The exact terms and conditions can be found at [www.ledvance.co.uk/guarantee](http://www.ledvance.co.uk/guarantee) | <sup>2</sup> t[h]: L70/B50 @ 25°C (T<sub>a</sub>) / t[h]: L80/B10 @ 25°C (T<sub>a</sub>)



## UK DAMP PROOF VALUE



Product name	Static Code	GTIN (EAN)	W	lm	lm/W	°	L70 <sup>2</sup>	L80 <sup>2</sup>	IK	L x W x H [mm] Ø x H [mm]
--------------	-------------	------------	---	----	------	---	------------------	------------------	----	------------------------------

## UK DAMP PROOF VALUE

NEW	DP VAL 1800 34W/4000K IP65	VDP1640	4058075300941	37	3700	110	115	30.000	30.000	IK08	86 x 1800 x 97
NEW	DP VAL 1800 70W/4000K IP65	VDP2640	4058075300989	70	7500	105	115	30.000	30.000	IK08	86 x 1800 x 97

- Evenly distributed light
- Energy savings of up to 50% (Compared to luminaires that use fluorescent lamps)



## DAMP PROOF HOUSING



Product name	Static Code	GTIN (EAN)	°	IK	L x W x H [mm] Ø x H [mm]
--------------	-------------	------------	---	----	------------------------------

## DAMP PROOF HOUSING

NEW	DP HOUSING 600 1x Lamp IP65	DPH12	4058075312395	105	IK08	651 x 69x 70
NEW	DP HOUSING 600 2x Lamp IP65	DPH22	4058075312418	105	IK08	651 x 107x 70
NEW	DP HOUSING 1200 1x Lamp IP65	DPH14	4058075312432	105	IK08	1261 x 69x 70
NEW	DP HOUSING 1200 2x Lamp IP65	DPH24	4058075312456	105	IK08	1261 x 107x 70
NEW	DP HOUSING 1500 1x Lamp IP65	DPH15	4058075312470	105	IK08	1561 x 69x 70
NEW	DP HOUSING 1500 2x Lamp IP65	DPH25	4058075312494	105	IK08	1561 x 107x 70

- Prewired for easy installation of tubular AC LED lamps
- Robust housing
- Easy and quick installation

<sup>1</sup> The exact terms and conditions can be found at [www.ledvance.co.uk/guarantee](http://www.ledvance.co.uk/guarantee)

# HIGH BAY LUMINAIRES

## HIGH BAY DALI: HIGH EFFICIENCY AND OPTIMUM QUALITY OF LIGHT

**NEW**

### NEW: HIGH BAY DALI REFRACTOR

Thanks to the high-quality optics and clever distribution of light, the new High Bay Dali with a 70° or 80° PC refractor is also ideal for prestige applications.

**CONSTANT LUMEN OUTPUT** throughout the entire life of 50,000 hours – the High Bay DALI CLO\* version

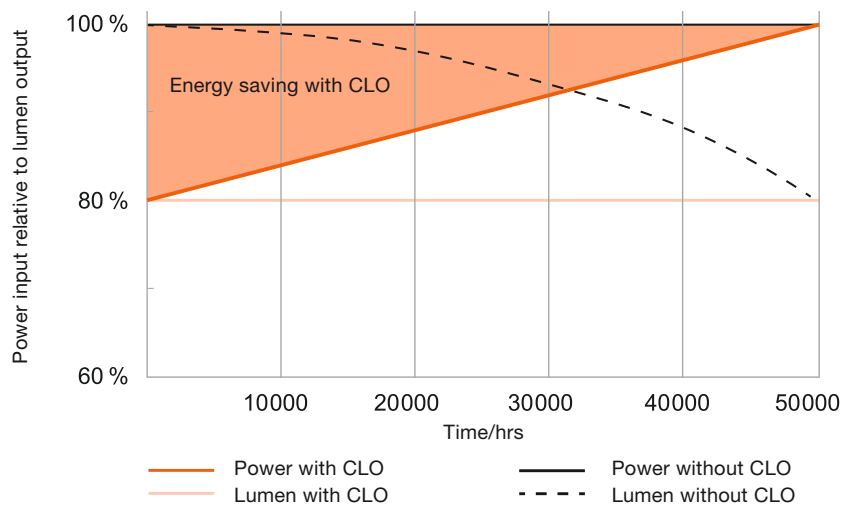

\* CLO = Constant Lumen Output



## HIGH BAY DALI



Product name	Static Code	GTIN (EAN)	W	lm	lm/W	°	L70 <sup>2</sup>	L80 <sup>2</sup>	IK	L x W x H [mm] Ø x H [mm]	
--------------	-------------	------------	---	----	------	---	------------------	------------------	----	------------------------------	--

## HIGH BAY DALI

NEW	HB DALI 90 W 4000 K 115 DEG IP65 BK	HBDA9040	4058075130685	90	13000	140	115	80.000	50.000	IK08	330x130	✓
NEW	HB DALI 155 W 4000 K 115 DEG IP65 BK	HBDA15540	4058075130678	155	22000	140	115	80.000	50.000	IK08	360x131	✓

- High compatibility thanks to DALI-2 certification
- DALI 2.0 interface for dimming and sensor operations
- Low flicker light thanks to special electronic control gear
- High luminous efficacy
- Easy electrical connection due to push button connector
- Energy savings of up to 90% compared to conventional high bay luminaires



## HIGH BAY DALI CONSTANT LUMEN OUTPUT



Product name	Static Code	GTIN (EAN)	W	lm	lm/W	°	IK	L x W x H [mm] Ø x H [mm]	
--------------	-------------	------------	---	----	------	---	----	------------------------------	--

## HIGH BAY DALI CONSTANT LUMEN OUTPUT

NEW	HB DALI CLO 90 W 4000 K 115 DEG IP65 BK	HBDA CLO9040	4058075130661	75...90	10500	115	115	IK08	330x130	✓
NEW	HB DALI CLO 155 W 4000 K 115 DEG IP65 BK	HBDA CLO15540	4058075130654	125...155	17500	115	115	IK08	360x131	✓

- Same luminous flux over the luminaire's lifetime thanks to constant lumen function
- High compatibility thanks to DALI-2 certification
- DALI 2.0 interface for dimming and sensor operations
- Low flicker light thanks to special electronic control gear
- High luminous efficacy
- Easy electrical connection due to push button connector

<sup>1</sup> The exact terms and conditions can be found at [www.ledvance.co.uk/guarantee](http://www.ledvance.co.uk/guarantee) | <sup>2</sup> t[h]: L70/B50 @ 25°C (T<sub>a</sub>) / t[h]: L80/B10 @ 25°C (T<sub>a</sub>)



## HIGH BAY DALI ACCESSORIES

LEDVANCE  
2 year guarantee

Product name	Static Code	GTIN (EAN)		L x W x H [mm]	Ø x H [mm]	
<b>HIGH BAY DALI REFLECTOR</b>						
NEW HB DALI REFLECTOR 90 W 80 DEG SI	HBDA90REF	4058075157453		80	406 x 204	1
NEW HB DALI REFLECTOR 155 W 80 DEG SI	HBDA155REF	4058075157477		80	472 x 224	1
<b>HIGH BAY DALI REFRACTOR</b>						
NEW HB DALI REFRACTOR 90 W 80DEG CL	HBDA90REFR	4058075305922		80	413 x 259	2
NEW HB DALI REFRACTOR 155 W 70DEG CL	HBDA155REFR	4058075305939		70	480 x 295	2
<b>HIGH BAY DALI BRACKET</b>						
NEW HB DALI BRACKET 90 W	HBDA90BKT	4058075157484		-	263 x 213 x 40	3
NEW HB DALI BRACKET 155 W	HBDA155BKT	4058075157507		-	277 x 233 x 40	3



## HIGH BAY Gen 1

IP65



LEDVANCE  
5 year guarantee

Product name	Static Code	GTIN (EAN)	W	lm	lm/w		L70 <sup>2</sup>	L80 <sup>2</sup>	IK	L x W x H [mm]	Ø x H [mm]
<b>HIGH BAY Gen 1</b>											
HIGH BAY LED 250 W 4000 K BK	HB25040/70	4058075255432	250	30000	120	70	50.000	35.000	IK08	452 x 160	
HIGH BAY LED 250 W 6500 K BK	HB25065/70	4058075255449	250	30000	120	70	50.000	35.000	IK08	452 x 160	

- High luminous efficacy
- Exclusive LEDVANCE design
- Energy savings of up to 60% compared to conventional high bay luminaires
- Optimised weight and size due to compact design

<sup>1</sup> The exact terms and conditions can be found at [www.ledvance.co.uk/guarantee](http://www.ledvance.co.uk/guarantee) | <sup>2</sup> t[h]: L70/B50 @ 25°C (T<sub>a</sub>) / t[h]: L80/B10 @ 25°C (T<sub>a</sub>)



## HIGH BAY Gen 2



Product name	Static Code	GTIN (EAN)	W	lm	lm/W		L70 <sup>2</sup>	L80 <sup>2</sup>	IK	L x W x H [mm] Ø x H [mm]
--------------	-------------	------------	---	----	------	--	------------------	------------------	----	------------------------------

## HIGH BAY Gen 2

HB 95 W 4000 K 90DEG IP65 BK	HB9540/90	4058075074330	95	13000	135	90	50.000	35.000	IK08	285 x 130
HB 95 W 4000 K 110DEG BK IP65	HB9540/110	4058075074354	95	13000	135	110	50.000	35.000	IK08	285 x 130
HB 95 W 6500 K 90DEG IP65 BK	HB9565/90	4058075074347	95	13000	135	90	50.000	35.000	IK08	285 x 130
HB 165 W 4000 K 70DEG BK IP65	HB16540/70	4058075074361	165	22000	135	70	50.000	35.000	IK08	376 x 139
HB 165 W 6500 K 70DEG IP65 BK	HB16565/70	4058075074378	165	22000	135	70	50.000	35.000	IK08	376 x 139
HB 200 W 4000 K 110DEG IP65 BK	HB20040/110	4058075074385	200	27000	135	110	50.000	35.000	IK08	376 x 139

- High luminous efficacy
- Exclusive LEDVANCE design
- Energy savings of up to 60% compared to conventional high bay luminaires
- Optimised weight and size due to compact design

<sup>1</sup> The exact terms and conditions can be found at [www.ledvance.co.uk/guarantee](http://www.ledvance.co.uk/guarantee) | <sup>2</sup> t[h]: L70/B50 @ 25°C (T<sub>a</sub>) / t[h]: L80/B10 @ 25°C (T<sub>a</sub>)

# FLOODLIGHTS

## FLOODLIGHTS: THE RIGHT LIGHT FOR ANY PROJECT

**NEW**



### FLOODLIGHT PERFORMANCE: POWERFUL AND PRECISE

Thanks to their high lumen output the luminaires are perfect replacements for luminaires with traditional high-pressure discharge lamps. Their precise distribution of light with different beam angles also makes them suitable for a wide range of applications. The extremely robust and durable luminaire features IP66 and IK08 protection.

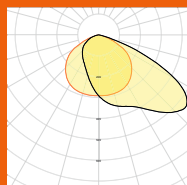

**Distribution of light: ASYM**  
55 x 110

**Asymmetrical wide beam 55° x 110°**  
Main application: Illumination of areas, car parks, sports grounds and facades

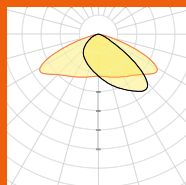

**Distribution of light: ASYM**  
45 x 140

**Asymmetrical extra wide beam 45° x 140°**  
Main application: Illumination of large areas, parking lots and (industrial) roads

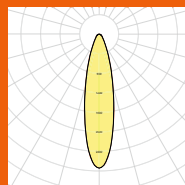

**Distribution of light: SYM**  
R30

**Rotationally symmetrical 30°**  
Main application: Sports fields, illumination of very large areas and parking lots



### FLOODLIGHT 100DEG VERSATILE ALL-ROUNDERS

As all-round floodlights, they cover a wide product portfolio: with eight output levels, three colour temperatures, housings in black and white they can satisfy an extremely wide range of requirements.



### FLOODLIGHT SENSOR AND PHOTOCELL SENSOR: INTELLIGENT AND EFFICIENT

Floodlight Sensor offers all the benefits of the standard floodlights and is equipped with a daylight and motion sensor. The Floodlight Photocell, on the other hand, has an integrated daylight sensor for automatic on/off switching depending on the amount of available sunlight.

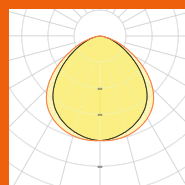

**Distribution of light: SYM**  
100

**Symmetrical light distribution 100° x 100°**  
Main application: Standard applications (facades, industry, underpasses, etc.)





1

2

## FLOODLIGHT PERFORMANCE



Product name	Static Code	GTIN (EAN)	W	lm	lm/W	°	L70 <sup>2</sup>	L80 <sup>2</sup>	IK	L x W x H [mm] Ø x H [mm]	Light No.
--------------	-------------	------------	---	----	------	---	------------------	------------------	----	------------------------------	-----------

### FLOODLIGHT PERFORMANCE ASYM 55x110

NEW	FL PFM ASYM 55x110 50 W 3000 K BK	FP5030AYB	4058075353299	50	5800	115	55 ° x 110	100.000	70.000	IK08	314 x 240 x 63	1
NEW	FL PFM ASYM 55x110 50 W 4000 K BK	FP5040AYB	4058075353305	50	6300	125	55 ° x 110	100.000	70.000	IK08	314 x 240 x 63	1
NEW	FL PFM ASYM 55x110 100 W 3000 K BK	FP10030AYB	4058075353312	100	11900	120	55 ° x 110	100.000	70.000	IK08	418 x 330 x 77	1
NEW	FL PFM ASYM 55x110 100 W 4000 K BK	FP10040AYB	4058075353527	100	12900	130	55 ° x 110	100.000	70.000	IK08	418 x 330 x 77	1
NEW	FL PFM ASYM 55x110 150 W 3000 K BK	FP15030AYB	4058075353534	150	18400	125	55 ° x 110	100.000	70.000	IK08	451 x 330 x 77	1
NEW	FL PFM ASYM 55x110 150 W 4000 K BK	FP15040AYB	4058075353541	150	19900	135	55 ° x 110	100.000	70.000	IK08	451 x 330 x 77	1
NEW	FL PFM ASYM 55x110 200 W 3000 K BK	FP20030AYB	4058075353558	200	24400	130	55 ° x 110	100.000	70.000	IK08	494 x 395 x 87	1
NEW	FL PFM ASYM 55x110 200 W 4000 K BK	FP20040AYB	4058075353565	200	26400	140	55 ° x 110	100.000	70.000	IK08	494 x 395 x 87	1
NEW	FL PFM ASYM 55x110 290 W 3000 K BK	FP29030AYB	4058075353572	290	35600	125	55 ° x 110	100.000	70.000	IK08	567 x 465 x 97	1
NEW	FL PFM ASYM 55x110 290 W 4000 K BK	FP29040AYB	4058075353602	290	38500	135	55 ° x 110	100.000	70.000	IK08	567 x 465 x 97	1

### FLOODLIGHT PERFORMANCE ASYM 45x140

NEW	FL PFM ASYM 45x140 50 W 3000 K BK	FP5030AYB140	4058075353619	50	5700	115	45 ° x 140	100.000	70.000	IK08	314 x 240 x 63	1
NEW	FL PFM ASYM 45x140 50 W 4000 K BK	FP5040AYB140	4058075353626	50	6200	125	45 ° x 140	100.000	70.000	IK08	314 x 240 x 63	1
NEW	FL PFM ASYM 45x140 100 W 3000 K BK	FP10030AYB140	4058075353633	100	11800	120	45 ° x 140	100.000	70.000	IK08	418 x 330 x 77	1
NEW	FL PFM ASYM 45x140 100 W 4000 K BK	FP10040AYB140	4058075353688	100	12800	130	45 ° x 140	100.000	70.000	IK08	418 x 330 x 77	1
NEW	FL PFM ASYM 45x140 150 W 3000 K BK	FP15030AYB140	4058075353695	150	18300	120	45 ° x 140	100.000	70.000	IK08	451 x 330 x 77	1
NEW	FL PFM ASYM 45x140 150 W 4000 K BK	FP15040AYB140	4058075353701	150	19800	130	45 ° x 140	100.000	70.000	IK08	451 x 330 x 77	1
NEW	FL PFM ASYM 45x140 200 W 3000 K BK	FP20030AYB140	4058075353718	200	24200	130	45 ° x 140	100.000	70.000	IK08	494 x 395 x 87	1
NEW	FL PFM ASYM 45x140 200 W 4000 K BK	FP20040AYB140	4058075353725	200	26200	140	45 ° x 140	100.000	70.000	IK08	494 x 395 x 87	1
NEW	FL PFM ASYM 45x140 290 W 3000 K BK	FP29030AYB140	4058075353732	290	35300	120	45 ° x 140	100.000	70.000	IK08	567 x 465 x 97	1
NEW	FL PFM ASYM 45x140 290 W 4000 K BK	FP29040AYB140	4058075353749	290	38200	130	45 ° x 140	100.000	70.000	IK08	567 x 465 x 97	1

### FLOODLIGHT PERFORMANCE SYM R30

NEW	FL PFM SYM R30 150 W 3000 K BK	FP15030B	4058075353756	150	18700	125	30	100.000	70.000	IK08	451 x 330 x 77	2
NEW	FL PFM SYM R30 150 W 4000 K BK	FP15040B	4058075353763	150	20200	135	30	100.000	70.000	IK08	451 x 330 x 77	2
NEW	FL PFM SYM R30 200 W 3000 K BK	FP20030B	4058075353770	200	24800	130	30	100.000	70.000	IK08	494 x 395 x 87	2
NEW	FL PFM SYM R30 200 W 4000 K BK	FP20040B	4058075353787	200	26800	140	30	100.000	70.000	IK08	494 x 395 x 87	2
NEW	FL PFM SYM R30 290 W 3000 K BK	FP29030B	4058075353794	290	26200	125	30	100.000	70.000	IK08	567 x 465 x 97	2
NEW	FL PFM SYM R30 290 W 4000 K BK	FP29040B	4058075353800	290	39100	135	30	100.000	70.000	IK08	567 x 465 x 97	2

- Energy savings of up to 90% compared to halogen lamp floodlights
- Energy savings of up to 45% compared to luminaires that use conventional discharge lamps
- Bright, robust and durable
- Homogeneous luminance distribution and reduced glare
- No upper light output ratio (ULOR 0%) when mounted at 0° tilt
- Key hole to ensure ease of installation

<sup>1</sup> The exact terms and conditions can be found at [www.ledvance.co.uk/guarantee](http://www.ledvance.co.uk/guarantee) | <sup>2</sup> t[h]: L70/B50 @ 25°C (T<sub>a</sub>) / t[h]: L80/B10 @ 25°C (T<sub>a</sub>)



## FLOODLIGHT 100DEG

IP65   3 year guarantee

Product name	Static Code	GTIN (EAN)	W	lm	lm/w		L70 <sup>2</sup>	L80 <sup>2</sup>	IK	L x W x H [mm] Ø x H [mm]	 No.
--------------	-------------	------------	---	----	------	---	------------------	------------------	----	------------------------------	---

### FLOODLIGHT 10

FLOODLIGHT 10 W 3000 K IP65 BK	F1030B	4058075097360	10	1050	105	100 ° x 100	50.000	30.000	IK07	125x115x39	1
FLOODLIGHT 10 W 3000 K IP65 WT	F1030W	4058075097384	10	1050	105	100 ° x 100	50.000	30.000	IK07	125x115x39	1
FLOODLIGHT 10 W 4000 K IP65 BK	F1040B	4058075097407	10	1100	110	100 ° x 100	50.000	30.000	IK07	125x115x39	1
FLOODLIGHT 10 W 4000 K IP65 WT	F1040W	4058075097421	10	1100	110	100 ° x 100	50.000	30.000	IK07	125x115x39	1

### FLOODLIGHT 20

FLOODLIGHT 20 W 3000 K IP65 BK	F2030B	4058075097445	20	2100	105	100 ° x 100	50.000	30.000	IK07	130x140x41	2
FLOODLIGHT 20 W 3000 K IP65 WT	F2030W	4058075097469	20	2100	105	100 ° x 100	50.000	30.000	IK07	130x140x41	2
FLOODLIGHT 20 W 4000 K IP65 BK	F2040B	4058075097483	20	2200	110	100 ° x 100	50.000	30.000	IK07	130x140x41	2
FLOODLIGHT 20 W 4000 K IP65 WT	F2040W	4058075097506	20	2200	110	100 ° x 100	50.000	30.000	IK07	130x140x41	2
FLOODLIGHT 20 W 6500 K IP65 BK	F2065B	4058075097520	20	2200	110	100 ° x 100	50.000	30.000	IK07	130x140x41	2
FLOODLIGHT 20 W 6500 K IP65 WT	F2065W	4058075097544	20	2200	110	100 ° x 100	50.000	30.000	IK07	130x140x41	2

### FLOODLIGHT 30

<b>NEW</b> FLOODLIGHT 30 W 3000 K IP65 BK	F3030B	4058075251366	30	3150	110	100 ° x 100	50.000	30.000	IK07	140x150x42	3
<b>NEW</b> FLOODLIGHT 30 W 3000 K IP65 WT	F3030W	4058075251427	30	3150	110	100 ° x 100	50.000	30.000	IK07	140x150x42	3
<b>NEW</b> FLOODLIGHT 30 W 4000 K IP65 BK	F3040W	4058075251380	30	3300	110	100 ° x 100	50.000	30.000	IK07	140x150x42	3
<b>NEW</b> FLOODLIGHT 30 W 4000 K IP65 WT	F3040W	4058075251441	30	3300	110	100 ° x 100	50.000	30.000	IK07	140x150x42	3
<b>NEW</b> FLOODLIGHT 30 W 6500 K IP65 BK	F3065B	4058075251403	30	3300	110	100 ° x 100	50.000	30.000	IK07	140x150x42	3
<b>NEW</b> FLOODLIGHT 30 W 6500 K IP65 WT	F3065W	4058075251465	30	3300	110	100 ° x 100	50.000	30.000	IK07	140x150x42	3

### FLOODLIGHT 50

FLOODLIGHT 50 W 3000 K IP65 BK	F5030B	4058075097568	50	5250	105	100 ° x 100	50.000	30.000	IK07	155x180x46	4
FLOODLIGHT 50 W 3000 K IP65 WT	F5030W	4058075097582	50	5250	105	100 ° x 100	50.000	30.000	IK07	155x180x46	4
FLOODLIGHT 50 W 4000 K IP65 BK	F5040B	4058075097605	50	5500	110	100 ° x 100	50.000	30.000	IK07	155x180x46	4
FLOODLIGHT 50 W 4000 K IP65 WT	F5040W	4058075097629	50	5500	110	100 ° x 100	50.000	30.000	IK07	155x180x46	4
FLOODLIGHT 50 W 6500 K IP65 BK	F5065B	4058075097643	50	5500	110	100 ° x 100	50.000	30.000	IK07	155x180x46	4
FLOODLIGHT 50 W 6500 K IP65 WT	F5065W	4058075097667	50	5500	110	100 ° x 100	50.000	30.000	IK07	155x180x46	4

- Frosted cover made of tempered glass for uniform illumination
- Optimised weight and size due to compact design
- No upper light output ratio (ULOR 0%) when mounted at 0° tilt
- Energy savings of up to 90% compared to halogen lamp floodlights

<sup>1</sup> The exact terms and conditions can be found at [www.ledvance.co.uk/guarantee](http://www.ledvance.co.uk/guarantee) | <sup>2</sup> t[h]: L70/B50 @ 25°C (T<sub>a</sub>) / t[h]: L80/B10 @ 25°C (T<sub>a</sub>)



1 2 3 4

## FLOODLIGHT 100DEG



Product name	Static Code	GTIN (EAN)	W	lm	lm/W	$\Delta$	L70 <sup>2</sup>	L80 <sup>2</sup>	IK	L x W x H [mm] Ø x H [mm]	No.
--------------	-------------	------------	---	----	------	----------	------------------	------------------	----	------------------------------	-----

FLOODLIGHT 70												
NEW	FLOODLIGHT 70 W 3000 K IP65 BK	F7030B	4058075352131	70	7300	105	100 ° x 100	50.000	30.000	IK07	250 x 240 x 70	1
NEW	FLOODLIGHT 70 W 4000 K IP65 BK	F7040B	4058075251342	70	7700	110	100 ° x 100	50.000	30.000	IK08	250 x 240 x 70	1
NEW	FLOODLIGHT 70 W 6500 K IP65 BK	F7065B	4058075251359	70	7700	110	100 ° x 100	50.000	30.000	IK08	250 x 240 x 70	1
FLOODLIGHT 90												
NEW	FLOODLIGHT 90 W 3000 K IP65 BK	F9030B	4058075352148	90	9400	105	100 ° x 100	50.000	30.000	IK08	250 x 240 x 70	2
	FLOODLIGHT 90 W 4000 K IP65 BK	F9040B	4058075097681	90	10000	110	100 ° x 100	50.000	30.000	IK08	250 x 240 x 70	2
	FLOODLIGHT 90 W 6500 K IP65 BK	F9065B	4058075097698	90	10000	110	100 ° x 100	50.000	30.000	IK08	250 x 240 x 70	2
FLOODLIGHT 135												
NEW	FLOODLIGHT 135 W 3000 K IP65 BK	F13530B	4058075352155	135	14100	105	100 ° x 100	50.000	30.000	IK08	300 x 270 x 76	3
	FLOODLIGHT 135 W 4000 K IP65 BK	F13540B	4058075097704	135	15000	110	100 ° x 100	50.000	30.000	IK08	300 x 270 x 76	3
	FLOODLIGHT 135 W 6500 K IP65 BK	F13565B	4058075097711	135	15000	110	100 ° x 100	50.000	30.000	IK08	300 x 270 x 76	3
FLOODLIGHT 180												
NEW	FLOODLIGHT 180 W 3000 K IP65 BK	F18030B	4058075352162	180	18900	105	100 ° x 100	50.000	30.000	IK08	340 x 310 x 81	4
	FLOODLIGHT 180 W 4000 K IP65 BK	F18040B	4058075097728	180	20000	110	100 ° x 100	50.000	30.000	IK08	340 x 310 x 81	4
	FLOODLIGHT 180 W 6500 K IP65 BK	F18065B	4058075097735	180	20000	110	100 ° x 100	50.000	30.000	IK08	340 x 310 x 81	4

- Frosted cover made of tempered glass for uniform illumination
- Optimised weight and size due to compact design
- No upper light output ratio (ULOR 0%) when mounted at 0° tilt
- Energy savings of up to 90% compared to halogen lamp floodlights



1 2

## FLOODLIGHT SENSOR



Product name	Static Code	GTIN (EAN)	W	lm	lm/W	$\Delta$	L70 <sup>2</sup>	L80 <sup>2</sup>	IK	L x W x H [mm] Ø x H [mm]	No.
--------------	-------------	------------	---	----	------	----------	------------------	------------------	----	------------------------------	-----

FLOODLIGHT SENSOR 20												
NEW	FLOODLIGHT 20 W 3000 K IP65 BK S	F2030BS	4058075143531	20	2200	110	100 ° x 100	50.000	30.000	IK07	224 x 167 x 104	1
NEW	FLOODLIGHT 20 W 4000 K IP65 BK S	F2040BS	4058075143555	20	2200	110	100 ° x 100	50.000	30.000	IK07	224 x 167 x 104	1
FLOODLIGHT SENSOR 50												
NEW	FLOODLIGHT 50 W 3000 K IP65 BK S	F5030BS	4058075143579	50	5500	110	100 ° x 100	50.000	30.000	IK07	251 x 216 x 122	2
NEW	FLOODLIGHT 50 W 4000 K IP65 BK S	F5040BS	4058075143593	50	5500	110	100 ° x 100	50.000	30.000	IK07	251 x 216 x 122	2

- Easy adjustment of range, daylight and motion detection via rotary switch
- Frosted cover made of tempered glass for uniform illumination
- No upper light output ratio (ULOR 0%) when mounted at 0° tilt
- Energy savings of up to 90% compared to halogen lamp floodlights

<sup>1</sup> The exact terms and conditions can be found at [www.ledvance.co.uk/guarantee](http://www.ledvance.co.uk/guarantee) | <sup>2</sup> t[h]: L70/B50 @ 25 °C (T<sub>a</sub>) / t[h]: L80/B10 @ 25 °C (T<sub>a</sub>)



## FLOODLIGHT PHOTOCELL SENSOR



Product name	Static Code	GTIN (EAN)	W	lm	lm/W	Beam angle	L70 <sup>2</sup>	L80 <sup>2</sup>	IK	L x W x H [mm] Ø x H [mm]	Light No.
--------------	-------------	------------	---	----	------	------------	------------------	------------------	----	------------------------------	-----------

FLOODLIGHT PHOTOCELL SENSOR 70												
NEW	FLOODLIGHT SL 70 W 4000 K IP65 BK	F7040BP	4058075251335	70	7700	110	100 ° x 100	50.000	30.000	IK08	250 x 240 x 78	1
FLOODLIGHT PHOTOCELL SENSOR 90												
NEW	FLOODLIGHT SL 90 W 4000 K IP65 BK	F9040BP	4058075216778	90	10000	110	100 ° x 100	50.000	30.000	IK08	250 x 240 x 78	2
FLOODLIGHT PHOTOCELL SENSOR 135												
NEW	FLOODLIGHT SL 135 W 4000 K IP65 BK	F13540BP	4058075216785	135	15000	110	100 ° x 100	50.000	30.000	IK08	300 x 270 x 76	3
FLOODLIGHT PHOTOCELL SENSOR 180												
NEW	FLOODLIGHT SL 180 W 4000 K IP65 BK	F18040BP	4058075216792	180	20000	110	100 ° x 100	50.000	30.000	IK08	340 x 310 x 81	4

- Automatically switches on and off according to available daylight thanks to photocell light sensor
- Frosted cover made of tempered glass for uniform illumination
- No upper light output ratio (ULOR 0%) when mounted at 0° tilt
- Optimised weight and size due to compact design
- Energy savings of up to 90% compared to halogen lamp floodlights



## FLOODLIGHT VALUE



Product name	Static Code	GTIN (EAN)	W	lm	lm/W	Beam angle	L70 <sup>2</sup>	IK	L x W x H [mm] Ø x H [mm]
--------------	-------------	------------	---	----	------	------------	------------------	----	------------------------------

FLOODLIGHT VALUE										
NEW	FLOODLIGHT VALUE 10 W 4000 K IP65 BK	VF1040B	4058075268586	10	800	80	110 ° x 110	30.000	IK06	108 x 93 x 33
NEW	FLOODLIGHT VALUE 20 W 4000 K IP65 BK	VF2040B	4058075268609	20	1700	85	110 ° x 110	30.000	IK06	137 x 118 x 34
NEW	FLOODLIGHT VALUE 30 W 4000 K IP65 BK	VF3040B	4058075268623	30	2700	90	110 ° x 110	30.000	IK06	175 x 153 x 39
NEW	FLOODLIGHT VALUE 50 W 4000 K IP65 BK	VF5040B	4058075268647	50	4500	90	110 ° x 110	30.000	IK06	295 x 270 x 70
NEW	FLOODLIGHT VALUE 100 W 4000 K IP65 BK	VF10040B	4058075268661	100	9000	88	110 ° x 110	30.000	IK08	223 x 191 x 43

- Energy savings of up to 80% compared to halogen lamp floodlights
- Semi-frosted, tempered glass cover for uniform illumination
- Quick and simple installation thanks to low profile, compact and light weight design

<sup>1</sup> The exact terms and conditions can be found at [www.ledvance.co.uk/guarantee](http://www.ledvance.co.uk/guarantee) | <sup>2</sup> t[h]: L70/B50 @ 25°C (T<sub>a</sub>) / t[h]: L80/B10 @ 25°C (T<sub>a</sub>)



## FLOODLIGHT VALUE SENSOR



Product name	Static Code	GTIN (EAN)	W	lm	lm/w	°	L70 <sup>2</sup>	IK	L x W x H [mm] Ø x H [mm]
--------------	-------------	------------	---	----	------	---	------------------	----	------------------------------

### FLOODLIGHT VALUE SENSOR

NEW	FLOODLIGHT VALUE Sensor 10 W 4000 K IP44 BK	VF1040BS	4058075268685	10	800	80	110 ° x 110	30.000	IK06	154 x 93 x 63
NEW	FLOODLIGHT VALUE Sensor 20 W 4000 K IP44 BK	VF2040BS	4058075268708	20	1700	85	110 ° x 110	30.000	IK06	178 x 118 x 66
NEW	FLOODLIGHT VALUE Sensor 30 W 4000 K IP44 BK	VF5040BS	4058075268722	30	2700	90	110 ° x 110	30.000	IK06	211 x 153 x 66
NEW	FLOODLIGHT VALUE Sensor 50 W 4000 K IP44 BK	VF10040BS	4058075268746	50	4500	90	110 ° x 110	30.000	IK06	253 x 191 x 70

- Energy savings of up to 80% compared to halogen lamp floodlights
- Semi-frosted, tempered glass cover for uniform illumination
- Quick and simple installation thanks to low profile, compact and light weight design
- Demand optimised illumination due to flexible and programmable sensor

<sup>1</sup> The exact terms and conditions can be found at [www.ledvance.co.uk/guarantee](http://www.ledvance.co.uk/guarantee) | <sup>2</sup> t[h]: L70/B50 @ 25°C (T<sub>a</sub>) / t[h]: L80/B10 @ 25°C (T<sub>a</sub>)

# OUTDOOR DECORATIVE LUMINAIRES

## BEAUTIFUL LIGHT IS NOT A QUESTION OF SPACE: DECORATIVE FACADE AND PATHWAY LUMINAIRES



Our facade and pathway luminaires are setting standards in many ways. All outdoor luminaires are robust and weather resistant (IP54). They provide attractive, warm white illumination to create a welcoming atmosphere around residential buildings and hotels and in parks. These LED luminaires also combine a uniform design language with high quality aluminium housings.

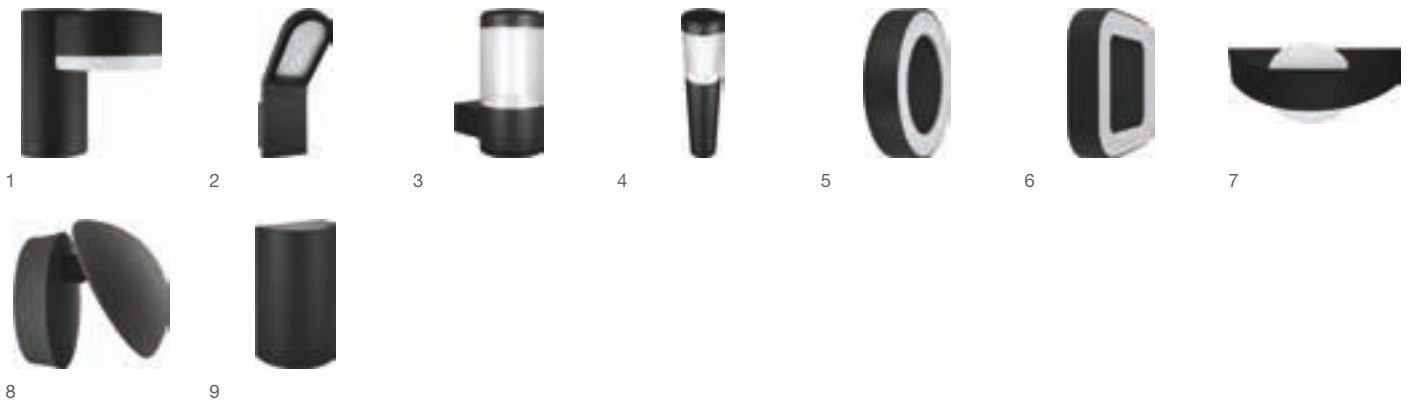

## OUTDOOR

IP 54



LEDVANCE  
5 year  
guarantee

Product name	Static Code	GTIN (EAN)	W	lm	lm/w		L70 <sup>2</sup>	IK	L x W x H [mm] Ø x H [mm]	
<b>OUTDOOR FACADE SPOT</b>										
O FACADE SPOT 8 W 3000 K IP54 GY	OFS30A	4058075074712	8	440	55	110	30.000	IK06	135x90x140	1
O FACADE SPOT 8 W 3000 K IP54 WT	OFS30W	4058075074736	8	460	60	110	30.000	IK06	135x90x140	1
<b>OUTDOOR FACADE EDGE</b>										
O FACADE EDGE 12 W 3000 K IP54 GY	OFE30A	4058075074750	12	740	60	110	30.000	IK06	168x100x273	2
O FACADE EDGE 12 W 3000 K IP54 WT	OFE30W	4058075074774	12	770	65	107	30.000	IK06	168x100x273	2
O FACADE EDGE SENSOR 12 W 3000 K IP54 S GY	OFE30AS	4058075074798	12	740	60	107	30.000	IK06	168x100x273	2
O FACADE EDGE SENSOR 12 W 3000 K IP54 S WT	OFE30WS	4058075074811	12	770	65	107	30.000	IK06	168x100x273	2
<b>OUTDOOR FACADE LANTERN</b>										
O FACADE LANTERN 12 W 3000 K IP54 GY	OFL30A	4058075074835	12	610	50	210	30.000	IK06	176x110x240	3
<b>OUTDOOR BOLLARD LANTERN</b>										
O BOLLARD 500 LANTERN 12 W 3000 K IP54 GY	OBL530A	4058075074859	12	610	50	210	30.000	IK06	110x500	4
O BOLLARD 900 LANTERN 12 W 3000 K IP54 GY	OBL930A	4058075074873	12	610	50	210	30.000	IK06	110x900	4
<b>OUTDOOR SURFACE ROUND</b>										
O SURFACE RD 13 W 3000 K IP54 GY	OSR30A	4058075074897	13	480	35	100	30.000	IK06	202x45	5
O SURFACE RD 13 W 3000 K IP54 WT	OSR30W	4058075074910	13	600	45	100	30.000	IK06	202x45	5
<b>OUTDOOR SURFACE SQUARE</b>										
O SURFACE SQ 13 W 3000 K IP54 GY	OSS30A	4058075074934	13	480	35	100	30.000	IK06	202x202x45	6
O SURFACE SQ 13 W 3000 K IP54 WT	OSS30W	4058075074958	13	600	45	100	30.000	IK06	202x202x45	6
<b>OUTDOOR FACADE BELT</b>										
O FACADE BELT RD 11 W 3000 K IP54 GY	OFBR30A	4058075074972	11	400	35	335	30.000	IK06	60x240x142	7
O FACADE BELT SQ 11 W 3000 K IP54 GY	OFBA30A	4058075074996	11	410	35	340	30.000	IK06	60x240x142	7
<b>OUTDOOR FACADE INDIRECT</b>										
O FACADE IND RD 13 W 3000 K IP54 GY	OFIR30A	4058075075016	13	480	35	240	30.000	IK06	150x118	8
LED FACADE INDIRECT 13 W 3000 K RD WT	OFIR30W	4058075075030	13	640	50	240	30.000	IK06	150x118	8
<b>OUTDOOR FACADE UPDOWN</b>										
O FACADE UPDOWN 12 W 3000 K IP54 GY	OFU30A	4058075075054	12	700	60	280	30.000	IK06	55x90x160	9
O FACADE UPDOWN 12 W 3000 K IP54 WT	OFU30W	4058075075078	12	710	60	280	30.000	IK06	55x90x160	9

- Energy-efficient thanks to LED technology
- Easy and quick installation
- Homogeneous light output

<sup>1</sup> The exact terms and conditions can be found at [www.ledvance.co.uk/guarantee](http://www.ledvance.co.uk/guarantee) | <sup>2</sup> t[h]: L70/B50 @ 25°C (T<sub>a</sub>) / t[h]: L80/B10 @ 25°C (T<sub>a</sub>)

# EMERGENCY LIGHTING

## SAFETY: A QUESTION OF LIGHT



With the right anti-panic or escape route lighting, buildings can be evacuated quickly and safely in the event of an emergency. The luminaires should be capable of operating even if there is a power outage. LEDVANCE offers a wide selection of certified emergency luminaires in two categories:

### **1. Luminaires with additional emergency lighting functionality**

The emergency lighting can be in the same style as the rest of the lighting installation. Many standard LEDVANCE luminaires are now available with emergency lighting functionality as single battery luminaires.

### **2. Emergency luminaires**

LEDVANCE offers a comprehensive range for escape route and anti-panic lighting which not only comply with the general safety guidelines for buildings but are also easy and flexible to install.



# LUMINAIRES WITH ADDITIONAL EMERGENCY LIGHTING FUNCTIONALITY

LEDVANCE offers an extensive portfolio of single battery emergency luminaires for general applications.

- Wide range of luminaires for general and emergency lighting
- Emergency luminaires certified to EN 60598-2-22
- Integrated automatic test function for simple testing of emergency lighting operation
- Integrated status indicator LEDs for useful visualisation of the test results
- Emergency lighting operated on a long-life LiFePO4 battery with a 3-hour discharge time



For details of the available EANs see the relevant product sections on 11, 30, 35, 42, 47, 65.



## EMERGENCY CONVERSION BOX – PLUG & PLAY EMERGENCY LIGHTING

The following selection of LEDVANCE panels and downlights can be upgraded to emergency luminaires with the Emergency Conversion Box:

Panel IndiviLED®  
Panel Performance HO  
Panel Performance  
Downlight Alu  
Downlight Slim Alu

For details go to  
[www.ledvance.co.uk/emergency](http://www.ledvance.co.uk/emergency)



# EMERGENCY LUMINAIRES FOR ANTI-PANIC AND ESCAPE ROUTE LIGHTING



For more information and planning aids for emergency luminaires see the eCatalog at [www.ledvance.co.uk/professional](http://www.ledvance.co.uk/professional)

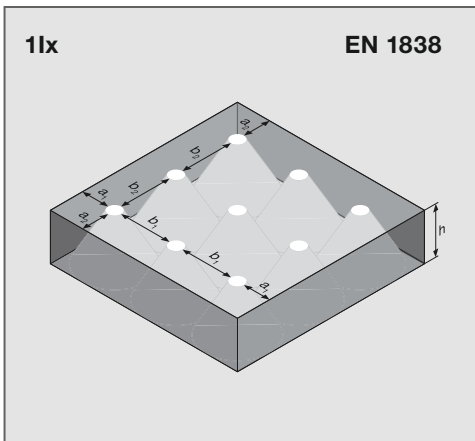

## ANTI-PANIC LIGHTING

h [m]	a <sub>1</sub> [m]	b <sub>1</sub> [m]	a <sub>2</sub> [m]	b <sub>2</sub> [m]
2.5	4.0	8.5	4.0	8.5
3.0	4.0	9.0	4.0	9.0
3.5	4.0	10.5	4.0	10.5
4.0	4.0	11.0	4.0	11.0
4.5	4.0	11.5	4.0	11.5
5.0	4.5	12.0	4.5	12.0
6.0	4.0	13.0	4.0	13.0
7.0	2.5	13.0	2.5	13.0
8.0	2.0	13.0	2.0	13.0

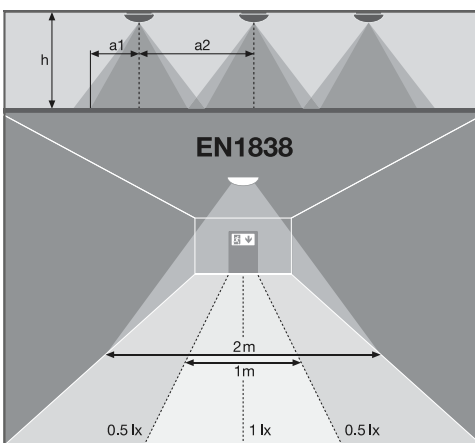

## ESCAPE ROUTE LIGHTING

h [m]	a <sub>1</sub> [m]	b <sub>1</sub> [m]
2.0	6.0	14.5
2.5	7.0	16.0
3.0	7.5	18.5
3.5	8.5	20.0
4.0	9.0	21.5
5.0	9.5	24.0
6.0	10.0	26.0
7.0	10.0	27.5
8.0	10.0	28.5



## EMERGENCY DOWNLIGHT DN120 AUTO TEST



Product name

Static Code

GTIN (EAN)

L x W x H [mm]  
Ø x H [mm]

## EMERGENCY DOWNLIGHT DN120 AUTO TEST

<b>NEW</b>	EM DL DN120 HO AT 3H Antipanic	EMDLHOANT	4058075124554	4	335	IK07	140 x 49
<b>NEW</b>	EM DL DN120 HO AT 3H Escape	EMDLHOESC	4058075124578	4	335	IK07	140 x 49

- Product family covers various types of emergency lighting applications
- High luminous flux and optimised light distribution
- High test temperature (850 °C) according to glow wire test rating IEC 60695-2-12
- High IK rating (IK07) according to impact test IEC 62262-2002
- Antipanic version comes with wide beam angle for open areas
- Escape version comes with direct beam angle for emergency escape routes/corridors



## EMERGENCY DOWNLIGHT DN120 MANUAL TEST



Product name

Static Code

GTIN (EAN)

L x W x H [mm]  
Ø x H [mm]

## EMERGENCY DOWNLIGHT DN120 MANUAL TEST

<b>NEW</b>	EM DL DN120 MT 3H Antipanic	EMDLMTANT	4058075124516	4	235	IK07	140 x 49
<b>NEW</b>	EM DL DN120 MT 3H Escape	EMDLMTESC	4058075124530	4	235	IK07	140 x 49

- Product family covers various types of emergency lighting applications
- High luminous flux and optimised light distribution
- High test temperature (850 °C) according to glow wire test rating IEC 60695-2-12
- High IK rating (IK07) according to impact test IEC 62262-2002
- Antipanic version comes with wide beam angle for open areas
- Escape version comes with direct beam angle for emergency escape routes/corridors

<sup>1</sup> The exact terms and conditions can be found at [www.ledvance.co.uk/guarantee](http://www.ledvance.co.uk/guarantee)



## EMERGENCY DOWNLIGHT DN120 MOUNT KIT

LEDVANCE  
**2**  
year  
guarantee<sup>1</sup>

Product name	Static Code	GTIN (EAN)	L x W x H [mm] Ø x H [mm]
<b>EMERGENCY DOWNLIGHT DN120 MOUNT KIT</b>			
<b>NEW</b> EM DL Surface Mount Kit	EMDLSMK	4058075124592	140 x 49



## EMERGENCY EXIT SIGN HB 27M



LEDVANCE  
**3**  
year  
guarantee<sup>1</sup>

Product name	Static Code	GTIN (EAN)	W	IK	L x W x H [mm] Ø x H [mm]
<b>EMERGENCY EXIT SIGN HB 27M</b>					
<b>NEW</b> EM SIGN HB 27M 3/8H AT	EMEXITHB	4058075144484	4	IK06	274 x 40 x 195

- Flexible mounting options
- 4 pictograms (left, right, up, down) acc. to ISO 7010 and reflective white foil included
- Compact and modern design with extruded Aluminum housing
- High and homogeneous brightness complying with requirements of DIN4844-1
- High IK rating (IK06) according to impact test IEC 62262-2002

<sup>1</sup> The exact terms and conditions can be found at [www.ledvance.co.uk/guarantee](http://www.ledvance.co.uk/guarantee)



## EMERGENCY EXIT SIGN HB 27M ACCESSORIES

  
**2** year guarantee

Product name	Static Code	GTIN (EAN)	L x W x H [mm] Ø x H [mm]
<b>EMERGENCY EXIT SIGN HB 27M ACCESSORIES</b>			
<b>NEW</b> EM SIGN HB 27M Wall Bracket	EMSIGNWMB	4058075144507	274 x 42 x 62
<b>NEW</b> EM SIGN HB 27M Flag Bracket	EMSIGNFLAG	4058075144521	290 x 40 x 76
<b>NEW</b> EM SIGN HB 27M Suspension Pole Kit	EMSIGNSPK	4058075144545	274 x 40 x 387
<b>NEW</b> EM SIGN HB 27M Suspension Chain Kit	EMSIGNSCCK	4058075144569	274 x 40 x 2087
<b>NEW</b> EM SIGN HB 27M Recessed Frame	EMSIGNRMF	4058075144583	359 x 60 x 60



## EMERGENCY CONVERSION BOX

  
**IP 20**

  
**3** year guarantee

Product name	Static Code	GTIN (EAN)	L x W x H [mm] Ø x H [mm]
<b>EMERGENCY CONVERSION BOX</b>			
<b>NEW</b> EM Conversion Box	EMCONVBOX	4058075237025	292 x 81 x 41

- Conversion of selected LEDVANCE panels and downlights to emergency luminaires
- Emergency conversion unit reduces stock keeping complexity from emergency lighting
- Plug-and-play system allows easy installation
- Simple testing of luminaires with emergency lighting function thanks to integrated automatic test function
- Operation of integrated emergency lighting function with long life LiFePO4 battery with 3h battery discharge time

<sup>1</sup> The exact terms and conditions can be found at [www.ledvance.co.uk/guarantee](http://www.ledvance.co.uk/guarantee)

# TAILOR-MADE CALCULATIONS – WITH OUR FAST LIGHT CALCULATION TOOL OR

We have put together our tools and services for achieving accurate calculations for your projects. DO you want quick information from the Fast Light calculation tool or detailed professional planning with DIALux and RELUX? We'll give you individual advice and, together with you, we'll plan the optimum lighting for your complete project.

## QUICK & EASY

## FAST LIGHT CALCULATION TOOL

With the handy calculation tool on our website, we offer installers and lighting professionals a quick and easy way to plan lighting projects successfully. The results are compiled in a PDF document which you can attach to your email tenders, for example. For more information go to [ledvance.co.uk/flct](http://ledvance.co.uk/flct)



## THE INFORMATION PROVIDED BY THE TOOL INCLUDES THE FOLLOWING:

- Number of luminaires needed
- Floor plan showing the distribution of the luminaires
- Illuminance, total power (W) and specific load (W/m<sup>2</sup>)
- Light distribution curve for every luminaire

The Fast Light Calculation Tool is no substitute for comprehensive professional planning with DIALux or any other professional light planning software.

## MORE BENEFITS FOR YOU:

- Intuitive operation of the tool
- Preselection of application areas with minimum lux values
- Info boxes explaining the values to be entered
- Generation of a final PDF with the results, including a floor plan showing the distribution of the luminaires

# DIALUX/RELUX

## PROFESSIONAL

### DIALUX AND RELUX

Good news for DIALux and RELUX users: Since the start of 2018 LEDVANCE has been working with the software producers. DIALux and RELUX users can now easily integrate LEDVANCE products in their lighting plans. Our luminaire data is also BIM-compatible. We also support users with customised advice on planning their lighting systems and offer tailored solutions for an extremely wide variety of lighting requirements – all entirely from a single source.

### SAMPLE DIALUX CALCULATION WITH TRUSYS® PFM 50 W/4000 K

**ROOM DEFINITION**  
Industrial storage

**ROOM DIMENSIONS**

- Floor area: 1,500 m<sup>2</sup>
- Ceiling height: 8 m
- Installation height: 7 m

**REFLECTANCE**

- Ceiling: 70%
- Walls (4): 50%
- Flooring: 20%

**BASIS FOR CALCULATION**

- Relevant standard DIN EN12464-1
- Required illuminance  $E_m$ : 300 lx
- Required uniformity  $E_{min}/E_m$ : 0.40
- Maintenance factor: 0.80
- Boundary zone: 0.00 m

### RESULTS: ILLUMINANCE IN THE STORAGE ROOMS

Area	Average (target)	Min	Max	Uniformity $E_{min}/E_m$ (target)
work level, storage space	325 lx (300 lx)	168 lx	385 lx	0.516 (0.4)

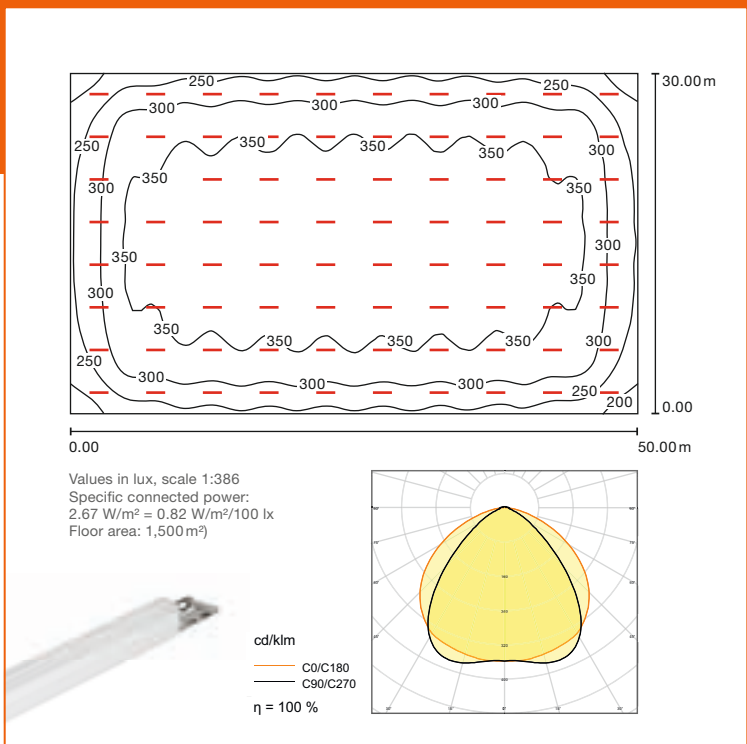

### YOUR BENEFITS AT A GLANCE

Tailored calculation for accurate planning of your project:

- Uniformly good light distribution
- Precise wattage per sqm
- Maximum efficient calculation of required number of luminaires

See for yourself.

# CASE STUDY: TYROL CLIN MODERN LED SOLUTIONS

## PROJECT:

Upgrade to LED lighting at Innsbruck hospital

**Vertical:** Facility management – Healthcare

**Application:** Lighting for hospitals and clinics

**Technology:** LED technology

## LEDVANCE PRODUCTS:

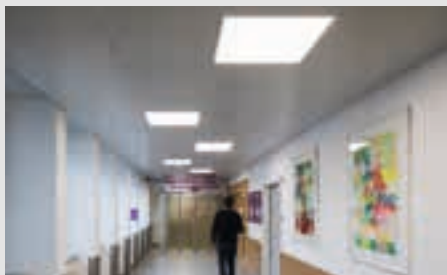

LED Panel



LED Panel 1200



LED Damp Proof



LED Downlight





# ICS – FROM A SINGLE SOURCE



The Tyrol clinics in the Innsbruck, Hall and Hochzirl-Natters hospitals are committed to sustainability – especially in terms of energy management. The lighting at Innsbruck hospital has consequently been upgraded step-by-step to LED technology since 2016. Among other things, about **6,000 modern LED luminaires from LEDVANCE** have been installed in that time, for example in the corridors of the central supply building, in the underground garage, in the lift areas and in the canteen. Patients, visitors and employees benefit not only from better quality of light. The LED luminaires also achieve **energy savings of up to 50%**. Other advantages for the Tyrol clinics include simple installation, longer **service life for the luminaires of up to 50,000 hours** and hence reduced expenditure for installation and maintenance.



#### THE MOST IMPORTANT FACTS AT A GLANCE:

- Around 6,000 new LED luminaires for Innsbruck hospital
- Energy savings for the lighting: up to 50%
- Cost savings: up to 50% including light source replacement costs
- Improved quality of light in various areas
- Simple installation, low maintenance

# HIGH-QUALITY, COMPACT AND EFFICIENT: LEDVANCE LED DRIVERS FOR CONSTANT CURRENT

LEDVANCE also offers the right solution for integration in LED luminaires or operation of independent indoor downlighting/spotlighting with its drivers for constant current (CC).

The wide range of high-quality SELV-insulated LEDVANCE constant current LED drivers with output currents of 250mA to 1400mA provides you with solid options for operating virtually all standard LED modules. Flexible power

settings allow for correct integration in different LED luminaires. Leading-edge and trailing-edge phase cut options are available for dimming applications. The compact housing design, optional cable clamps and simple wiring make installa-

tion quick and easy even in tight spaces, reducing your installation time and costs. The life of up to 50,000 hours is another strong argument.



# LIGHTING CONTROL FROM OSRAM: DYNAMICS MEETS EFFICIENCY

## THE SYSTEM APPROACH TO GOOD LIGHT – LIGHT MANAGEMENT SYSTEMS

Light management systems (LMS) comprise all the components needed for dynamic and intelligent lighting. These include LED drivers with DALI interfaces integrated in the luminaires. Other components in light management systems ensure that the luminaires are operated at high levels of comfort, convenience and energy efficiency. For example, light and motion sensors dim the light as soon as a room lit by natural light. They also switch the light on only if there is someone in the room. Considerable energy savings can therefore be achieved.

# OSRAM

Products of OSRAM GmbH,  
distributed by LEDVANCE

## SMARTPHONE CONTROL

DALI ACU BT or LUXeye control units together with appropriate DALI luminaires and sensors (e.g. OSRAM DALI LS/PD CI) form a unit that is both effective and user-friendly. Not least because the parameters of the system can be conveniently operated from a smartphone or tablet. An ideal solution for everything from spotlighting and panel lighting to linear light (see page 14, 28, 44).



## OSRAM DALI ACU BT

Dynamic and efficient lighting control

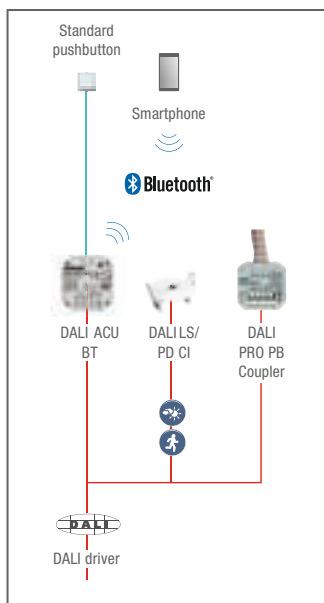

## OSRAM LUXEYE SENSOR LS/PD

Additional sensor-based energy savings

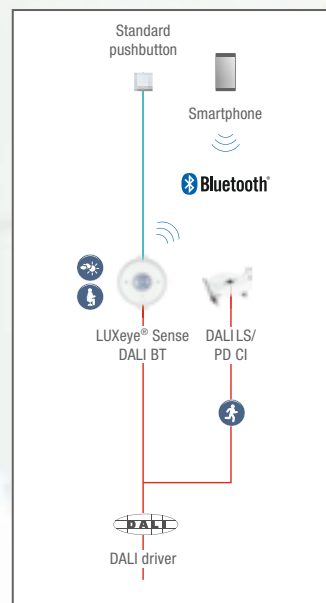

# LEDVANCE: ADVANCING LIGHT

## BAD LIGHT MAKES YOU SCREAM? WE'VE GOT A SOLUTION FOR THAT!

As a trusted partner for general lighting, all our actions are directed at the fight against bad light. At LEDVANCE we combine traditional and modern, future-oriented lighting technologies. We build on long-term customer relationships and a strong sales network. We are experts in general lighting throughout the world, in technology trends and in the rapidly changing requirements for good light.

As a strong local partner, we are represented in over 140 countries. Our team of specialists focuses on the specific demands of our customers – whether they need luminaires, lamps or electronic components. The extensive LEDVANCE portfolio covers virtually every professional and residential application – from basic to sophisticated lighting.

The LEDVANCE luminaire portfolio is geared towards the wishes of our customers. Each product development is based on our core philosophy: to offer user-friendly, intelligent lighting solutions that aim to improve the well-being of people. And all this in the context of an LED product range that combines extensive options, technical innovation and reliable performance.

Because we always focus on the practical benefits for you as a lighting professional, our luminaires are also easy to plan, easy to install and easy to combine.

Based on these principles, we will continue to develop sophisticated products and provide you with optimum support in your personal fight against bad light.



# OUR NEW PRODUCT RANGE: ONE PORTFOLIO AND MANY GOOD REASONS

Why do lighting professionals and retail customers opt for LEDVANCE? Because we are one of the world's leading providers of general lighting – with more than 100 years of experience. Because we can offer our customers a comprehensive portfolio of LED luminaires, LED lamps, LED strip systems with suitable drivers and traditional lamps under one roof. And because our product range allows us to create tailored lighting solutions – from shops to industrial lighting.



## LED LUMINAIRES

Reliable performance, functional use: With three light distributions, the new high-performance Floodlight Performance, for example, ensures optimum individual illumination. The dimmable Tracklight Spot Zoom with manual zoom lens is

a versatile spotlight solution for a host of different shop applications. And the Panel Direct/Indirect offers enhanced comfort in offices thanks to its ideal mix of direct and indirect light.



## LED LAMPS

With the new range of LED lamps under the OSRAM brand, LEDVANCE offers lighting solutions that are both clever and user friendly. In the LED tube range, for example, the new SubstiTUBE® T5 Universal is an impressive, energy-efficient all-in-one innovation. New additions to the LED special lamp range, such as the SPECIAL T SLIM 60 and the new HQI LED HIGHBAY, make the switch to LED even easier now. The Vintage Edition 1906 with its eclectic design creates atmospheric light – now also available in the new smoked glass model.



## LED STRIP SYSTEM

The new LEDVANCE LED Strip System includes drivers, profiles and accessories in addition to LED strips. The LED strips are impressive for their long lifespan, low maintenance costs and high colour rendering index of up to CRI 90. With three application-related quality levels, five light colours and a broad range of luminous flux levels, the portfolio also allows for tailored use in ambient, cove and general lighting.

# WHENEVER AND WHEREVER: THE ONLINE PORTAL WITH ALL THE INFORMATION, ADVICE AND EXPERTISE

Are you looking for information about our products and services? LEDVANCE always keeps you up to date: at wholesalers, through our sales employees or via our Customer Service Centre (email: [csc.uk@ledvance.com](mailto:csc.uk@ledvance.com)). Here you'll find an overview of our competencies, databases and tools.



## ▶ PERFECTLY FILTERED

Use the online filters to find precisely what you're looking for in our luminaire portfolio – type of mounting, IP rating, light colour, etc.: [www.ledvance.co.uk/luminaires](http://www.ledvance.co.uk/luminaires)

## ▶ REFERENCES PROVIDE INSPIRATION

A selection of some top lighting projects can be found at: [www.ledvance.co.uk/projects](http://www.ledvance.co.uk/projects)

## ▶ LEDVANCE SERVICE-PLUS

Our specialised sales department supports and advises our commercial end customers – including face-to-face. Find out all you need to know at [www.ledvance.co.uk/vam](http://www.ledvance.co.uk/vam)

## ▶ DOWNLOAD CENTRE

Catalogs, compatibility overviews, brochures, and much more are available for you in our download centre: [www.ledvance.co.uk/download](http://www.ledvance.co.uk/download)

## ▶ OUR TOOLS FOR YOU

From the LED strip system configurator to the TCO calculator, you will find all the practical tools you need at [www.ledvance.co.uk/tools](http://www.ledvance.co.uk/tools)

## ▶ SERVICE AT A GLANCE

You will find a summary of all of our service offerings at [www.ledvance.co.uk/services](http://www.ledvance.co.uk/services)

## NEW: THE ONLINE TRAINING PLATFORM

A host of application-oriented eLearnings for professional users, practical advice on installation, integrated standards checks, planning tips, and much more.

Register and find out more at [www.training.ledvance.co.uk](http://www.training.ledvance.co.uk)

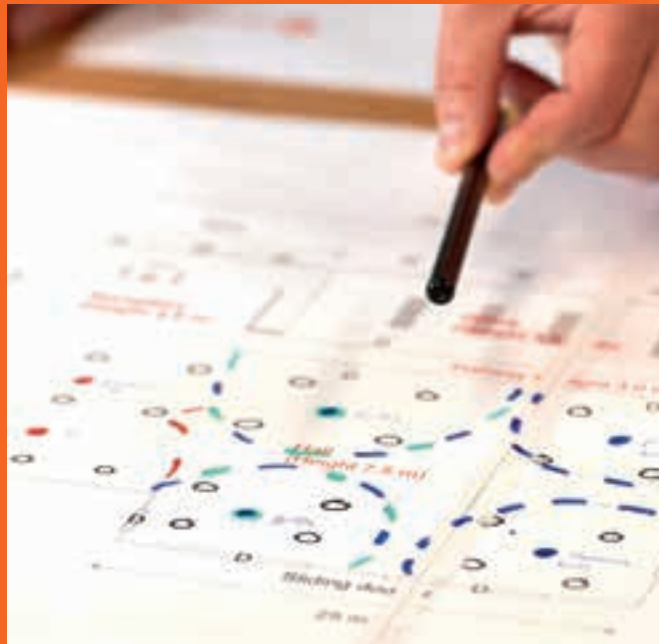

## FAST LIGHT CALCULATOR

Quick and easy calculation of your luminaire project with our Fast Light Calculation Tool\* [www.ledvance.co.uk/flct](http://www.ledvance.co.uk/flct)  
For details see page 86.

\* The Fast Light Calculation Tool is no substitute for comprehensive professional planning with DIALux or any other professional light planning software.

# SHEDDING LIGHT, SYMBOLS AND ABBREVIATIONS

	Type of protection		t [h]: L70/B50 @ 25 °C (T <sub>a</sub> )
	Type of protection, back/front		t [h]: L80/B10 @ 25 °C (T <sub>a</sub> )
	IK impact rating		Beam angle in °
	Colour rendering index		Energy efficiency class
	MacAdam colour consistency		Scale design
	Dimmable		Protection class I
	Luminous flux in lm		Protection class II
	Power in W		ENEC certification
	Colour temperature in K		TÜV certification
	Luminous efficacy		
	Guarantee		
	Sensor		
	Ceiling opening		

## LIST OF ABBREVIATIONS

<b>ASYM</b>	Asymmetric
<b>AT</b>	Auto Test
<b>BK</b>	Black
<b>CCT</b>	Correlated Colour Temperature
<b>CLO</b>	Constant Lumen Output
<b>D</b>	Direct
<b>DA</b>	Double asymmetric
<b>D/I</b>	Direct/ Indirect
<b>DEG</b>	Degree (beam angle)
<b>DK</b>	Dark Light (Cut-off)
<b>DL</b>	Downlight
<b>DN</b>	Diameter Nominal
<b>DP</b>	Damp Proof
<b>EM</b>	Emergency
<b>ER</b>	Energy Rail
<b>FL</b>	Flood (beam angle)
<b>Flood</b>	Floodlight
<b>FP</b>	Fire-Proof (fire rated up to ...)
<b>GY</b>	Grey
<b>HB</b>	High Bay
<b>IND</b>	Indirect
<b>INDV</b>	IndiviLED®
<b>LN</b>	Linear
<b>MT</b>	Manual Test
<b>MP</b>	Microprismatic (= UGR < 19)
<b>N</b>	Narrow
<b>NFL</b>	Narrow Flood (beam angle)
<b>O</b>	Outdoor
<b>OP</b>	Opal
<b>PFM</b>	Performance
<b>RD</b>	Round
<b>S</b>	Sensor
<b>SF</b>	Surface
<b>SI</b>	Silver
<b>SP</b>	Spot
<b>SQ</b>	Square
<b>Surface-C</b>	Surface Circular
<b>SYM</b>	Symmetric
<b>TH</b>	Through-wiring
<b>Track</b>	Tracklight
<b>UGR</b>	Unified Glare Rating
<b>UO</b>	Ultra Output
<b>VAL</b>	Value
<b>VN</b>	Very narrow beam angle
<b>VW</b>	Very wide beam angle
<b>W</b>	Wide (90° beam)
<b>WT</b>	White
<b>WW</b>	Wallwasher = asymmetric

## ABOUT LEDVANCE

With offices in more than 50 countries and business activities in more than 140 countries, LEDVANCE is one of the world's leading general lighting providers for professional users and end consumers. Having emerged from the general lighting business of OSRAM GmbH, LEDVANCE offers a wide-ranging assortment of LED luminaires for a broad spectrum of application areas, intelligent lighting products for Smart Homes and Buildings, one of the largest LED lamps portfolios in the industry as well as traditional light sources.



# LEDVANCE

LEDVANCE Ltd  
Aquila House  
Delta Crescent, Westbrook  
Warrington, WA5 7NR  
United Kingdom

LEDVANCE Ireland  
70 Sir John Rogerson's Quay  
Dublin 2  
Ireland

Telephone: +44 (0) 1925 465000  
Email: [csc.uk@ledvance.com](mailto:csc.uk@ledvance.com)

LEDVANCE is the expert partner for installers and lighting professionals. To match our extensive range of luminaires we also offer a large portfolio of innovative LED lamps in excellent quality and the new LED Strip System. Further information about our range of products and services is available online at [www.ledvance.co.uk](http://www.ledvance.co.uk)

With our mobile apps and online tools you can calculate potential savings for your next LED project in no time at all, find matching lamps, luminaires, strips or drivers and scroll through the latest catalogs: [www.ledvance.co.uk/tools](http://www.ledvance.co.uk/tools)

Partner:



REGISTERED MEMBER



theLIA



**LEDVANCE.CO.UK**  
**LEDVANCE.IE**