

1.5SMC Series

Surface Mount – 1500W



Additional Information



Resources



Accessories



Samples

Agency Approvals

| Agency | Agency File Number |
|--------|--------------------|
| | E230531 |

Maximum Ratings and Thermal Characteristics ($T_A=25^{\circ}\text{C}$ unless otherwise noted)

| Parameter | Symbol | Value | Unit |
|--|-----------------|------------|-----------------------------|
| Peak Pulse Power Dissipation(Fig.2) by 10/1000us Test Waveform(Fig.4) (Note 1),(Note 2) -Single Die Parts ¹ | P_{PPM} | 1500 | W |
| Peak Pulse Power Dissipation(Fig.2) by 10/1000us Test Waveform(Fig.4) (Note 1), (Note 2)-Stacked Die Parts (Note 5) | P_{PPM} | 2000 | W |
| Power Dissipation on Infinite Heat Sink at $T_L=50^{\circ}\text{C}$ | P_D | 6.5 | W |
| Peak Forward Surge Current, 8.3ms Single Half Sine Wave (Note 3) | I_{FSM} | 200 | A |
| Maximum Instantaneous Forward Voltage at 100A for Unidirectional Only (Note 4) | V_F | 3.5/5.0 | V |
| Operating Temperature Range | T_J | -65 to 150 | $^{\circ}\text{C}$ |
| Storage Temperature Range | T_{STG} | -65 to 175 | $^{\circ}\text{C}$ |
| Typical Thermal Resistance Junction to Lead | $R_{\theta JL}$ | 15 | $^{\circ}\text{C}/\text{W}$ |
| Typical Thermal Resistance Junction to Ambient | $R_{\theta JA}$ | 75 | $^{\circ}\text{C}/\text{W}$ |

Notes:

- Non-repetitive current pulse, per Fig. 4 and derated above T_J (initial) = 25°C per Fig. 3.
- Mounted on copper pad area of 0.31x0.31" (8.0 x 8.0mm) to each terminal.
- Measured on 8.3ms single half sine wave or equivalent square wave for unidirectional device only, duty cycle=4 per minute maximum.
- $V_F < 3.5\text{V}$ for single die parts and $V_F < 5.0\text{V}$ for stacked-die parts.
- For stacked die component details, please refer to part numbers labeled by * in Electrical Characteristics.

Description

The 1.5SMC series is designed specifically to protect sensitive electronic equipment from voltage transients induced by lightning and other transient voltage events.

Features & Benefits

- 1500W peak pulse power capability at 10/1000us waveform, repetition rate (duty cycles):0.01%
- Excellent clamping capability
- Low incremental surge resistance
- Typical I_R less than 1 μA when $V_{BR \text{ min}} > 12\text{V}$
- For surface mounted applications to optimize board space
- Low profile package
- Built-in strain relief
- Typical failure mode is short from over-specified voltage or current
- Whisker test is conducted based on JEDEC JESD201A per its table 4a and 4c
- IEC 61000-4-2 ESD 30kV(Air), 30kV (Contact)
- ESD protection of data lines in accordance with IEC 61000-4-2
- EFT protection of data lines in accordance with IEC 61000-4-4
- Fast response time: typically less than 1.0ps from 0V to BV min
- Glass passivated chip junction
- High temperature to reflow soldering guaranteed: 260 $^{\circ}\text{C}/30\text{sec}$
- $V_{BR} @ T_J = V_{BR} @ 25^{\circ}\text{C} \times (1 + \alpha_T \times (T_J - 25))$ (α_T : Temperature Coefficient, typical value is 0.1%)
- Plastic package is flammability rated V-0 per Underwriters Laboratories
- Meet MSL level1, per J-STD-020, LF maximum peak of 260 $^{\circ}\text{C}$
- Matte tin lead-free plated
- Halogen free and RoHS compliant
- Pb-free E3 means 2nd level interconnect is Pb-free and the terminal finish material is tin(Sn) (IPC/JEDEC J-STD-609A.01)

Applications

TVS devices are ideal for the protection of I/O Interfaces, V_{CC} bus and other vulnerable circuits used in Telecom, Computer, Industrial and Consumer electronic applications.

Functional Diagram



Bi-directional



Uni-directional

1.5SMC Series

Surface Mount – 1500W

Electrical Characteristics ($T_A=25^\circ\text{C}$ unless otherwise noted)

| Part Number (Uni) | Part Number (Bi) | Marking | | Reverse Stand off Voltage V_R (Volts) | Breakdown Voltage V_{BR} (Volts) @ I_T | | Test Current I_T (mA) | Maximum Clamping Voltage V_C @ I_{pp} (V) | Maximum Peak Pulse Current I_{pp} (A) | Maximum Reverse Leakage I_R @ V_R (μA) | Agency Approval  |
|-------------------|------------------|---------|------|---|--|--------|-------------------------|---|---|---|---|
| | | Uni | Bi | | Min | Max | | | | | |
| 1.5SMC6.8A | 1.5SMC6.8CA | 6V8A | 6V8C | 5.80 | 6.45 | 7.14 | 10 | 10.5 | 144.8 | 1000 | X |
| 1.5SMC7.5A | 1.5SMC7.5CA | 7V5A | 7V5C | 6.40 | 7.13 | 7.88 | 10 | 11.3 | 134.5 | 500 | X |
| 1.5SMC8.2A | 1.5SMC8.2CA | 8V2A | 8V2C | 7.02 | 7.79 | 8.61 | 10 | 12.1 | 125.6 | 200 | X |
| 1.5SMC9.1A | 1.5SMC9.1CA | 9V1A | 9V1C | 7.78 | 8.65 | 9.50 | 1 | 13.4 | 113.4 | 50 | X |
| 1.5SMC10A | 1.5SMC10CA | 10A | 10C | 8.55 | 9.50 | 10.50 | 1 | 14.5 | 104.8 | 10 | X |
| 1.5SMC11A | 1.5SMC11CA | 11A | 11C | 9.40 | 10.50 | 11.60 | 1 | 15.6 | 97.4 | 5 | X |
| 1.5SMC12A | 1.5SMC12CA | 12A | 12C | 10.20 | 11.40 | 12.60 | 1 | 16.7 | 91.0 | 5 | X |
| 1.5SMC13A | 1.5SMC13CA | 13A | 13C | 11.10 | 12.40 | 13.70 | 1 | 18.2 | 83.5 | 1 | X |
| 1.5SMC15A | 1.5SMC15CA | 15A | 15C | 12.80 | 14.30 | 15.80 | 1 | 21.2 | 71.7 | 1 | X |
| 1.5SMC16A | 1.5SMC16CA | 16A | 16C | 13.60 | 15.20 | 16.80 | 1 | 22.5 | 67.6 | 1 | X |
| 1.5SMC18A | 1.5SMC18CA | 18A | 18C | 15.30 | 17.10 | 18.90 | 1 | 25.2 | 60.3 | 1 | X |
| 1.5SMC20A | 1.5SMC20CA | 20A | 20C | 17.10 | 19.00 | 21.00 | 1 | 27.7 | 54.9 | 1 | X |
| 1.5SMC22A | 1.5SMC22CA | 22A | 22C | 18.80 | 20.90 | 23.10 | 1 | 30.6 | 49.7 | 1 | X |
| 1.5SMC24A | 1.5SMC24CA | 24A | 24C | 20.50 | 22.80 | 25.20 | 1 | 33.2 | 45.8 | 1 | X |
| 1.5SMC27A | 1.5SMC27CA | 27A | 27C | 23.10 | 25.70 | 28.40 | 1 | 37.5 | 40.5 | 1 | X |
| 1.5SMC30A | 1.5SMC30CA | 30A | 30C | 25.60 | 28.50 | 31.50 | 1 | 41.4 | 36.7 | 1 | X |
| 1.5SMC33A | 1.5SMC33CA | 33A | 33C | 28.20 | 31.40 | 34.70 | 1 | 45.7 | 33.3 | 1 | X |
| 1.5SMC36A | 1.5SMC36CA | 36A | 36C | 30.80 | 34.20 | 37.80 | 1 | 49.9 | 30.5 | 1 | X |
| 1.5SMC39A | 1.5SMC39CA | 39A | 39C | 33.30 | 37.10 | 41.00 | 1 | 53.9 | 28.2 | 1 | X |
| 1.5SMC43A | 1.5SMC43CA | 43A | 43C | 36.80 | 40.90 | 45.20 | 1 | 59.3 | 25.6 | 1 | X |
| 1.5SMC47A | 1.5SMC47CA | 47A | 47C | 40.20 | 44.70 | 49.40 | 1 | 64.8 | 23.5 | 1 | X |
| 1.5SMC51A | 1.5SMC51CA | 51A | 51C | 43.60 | 48.50 | 53.60 | 1 | 70.1 | 21.7 | 1 | X |
| 1.5SMC56A | 1.5SMC56CA | 56A | 56C | 47.80 | 53.20 | 58.80 | 1 | 77.0 | 19.7 | 1 | X |
| 1.5SMC62A | 1.5SMC62CA | 62A | 62C | 53.00 | 58.90 | 65.10 | 1 | 85.0 | 17.9 | 1 | X |
| 1.5SMC68A | 1.5SMC68CA | 68A | 68C | 58.10 | 64.60 | 71.40 | 1 | 92.0 | 16.5 | 1 | X |
| 1.5SMC75A | 1.5SMC75CA | 75A | 75C | 64.10 | 71.30 | 78.80 | 1 | 103.0 | 14.8 | 1 | X |
| 1.5SMC82A | 1.5SMC82CA | 82A | 82C | 70.10 | 77.90 | 86.10 | 1 | 113.0 | 13.5 | 1 | X |
| 1.5SMC91A | 1.5SMC91CA | 91A | 91C | 77.80 | 86.50 | 95.50 | 1 | 125.0 | 12.2 | 1 | X |
| 1.5SMC100A | 1.5SMC100CA | 100A | 100C | 85.50 | 95.00 | 105.00 | 1 | 137.0 | 11.1 | 1 | X |
| 1.5SMC110A | 1.5SMC110CA | 110A | 110C | 94.00 | 105.00 | 116.00 | 1 | 152.0 | 10.0 | 1 | X |
| 1.5SMC120A | 1.5SMC120CA | 120A | 120C | 102.00 | 114.00 | 126.00 | 1 | 165.0 | 9.2 | 1 | X |
| 1.5SMC130A | 1.5SMC130CA | 130A | 130C | 111.00 | 124.00 | 137.00 | 1 | 179.0 | 8.5 | 1 | X |
| 1.5SMC150A | 1.5SMC150CA | 150A | 150C | 128.00 | 143.00 | 158.00 | 1 | 207.0 | 7.3 | 1 | X |
| 1.5SMC160A | 1.5SMC160CA | 160A | 160C | 136.00 | 152.00 | 168.00 | 1 | 219.0 | 6.9 | 1 | X |
| 1.5SMC170A | 1.5SMC170CA | 170A | 170C | 145.00 | 162.00 | 179.00 | 1 | 234.0 | 6.5 | 1 | X |
| 1.5SMC180A | 1.5SMC180CA | 180A | 180C | 154.00 | 171.00 | 189.00 | 1 | 246.0 | 6.2 | 1 | X |
| 1.5SMC200A | 1.5SMC200CA | 200A | 200C | 171.00 | 190.00 | 210.00 | 1 | 274.0 | 5.5 | 1 | X |
| 1.5SMC220A | 1.5SMC220CA | 220A | 220C | 185.00 | 209.00 | 231.00 | 1 | 328.0 | 4.6 | 1 | X |
| 1.5SMC250A | 1.5SMC250CA | 250A | 250C | 214.00 | 237.00 | 263.00 | 1 | 344.0 | 4.4 | 1 | X |
| 1.5SMC300A | 1.5SMC300CA | 300A | 300C | 256.00 | 285.00 | 315.00 | 1 | 414.0 | 3.7 | 1 | X |
| 1.5SMC350A* | 1.5SMC350CA* | 350A | 350C | 300.00 | 332.00 | 368.00 | 1 | 482.0 | 4.2 | 1 | X |
| 1.5SMC400A* | 1.5SMC400CA* | 400A | 400C | 342.00 | 380.00 | 420.00 | 1 | 548.0 | 3.7 | 1 | X |
| 1.5SMC440A* | 1.5SMC440CA* | 440A | 440C | 376.00 | 418.00 | 462.00 | 1 | 602.0 | 3.4 | 1 | X |
| 1.5SMC480A* | 1.5SMC480CA* | 480A | 480C | 408.00 | 456.00 | 504.00 | 1 | 658.0 | 3.1 | 1 | X |
| 1.5SMC510A* | 1.5SMC510CA* | 510A | 510C | 434.00 | 485.00 | 535.00 | 1 | 698.0 | 2.9 | 1 | X |
| 1.5SMC530A* | 1.5SMC530CA* | 530A | 530C | 451.00 | 503.50 | 556.50 | 1 | 725.0 | 2.8 | 1 | X |
| 1.5SMC540A* | 1.5SMC540CA* | 540A | 540C | 460.00 | 513.00 | 567.00 | 1 | 740.0 | 2.8 | 1 | X |
| 1.5SMC550A* | 1.5SMC550CA* | 550A | 550C | 468.00 | 522.50 | 577.50 | 1 | 760.0 | 2.7 | 1 | X |
| 1.5SMC600A* | 1.5SMC600CA* | 600A | 600C | 512.00 | 570.00 | 630.00 | 1 | 828.0 | 2.5 | 1 | - |
| 1.5SMC650A* | - | 650A | - | 553.00 | 618.00 | 682.00 | 1 | 897.0 | 2.3 | 1 | - |

For bidirectional type having V_s of 10 volts and less, the I_s limit is double.

For parts without A, the V_{BR} is $\pm 10\%$ and V_C is 5% higher than with A parts, the parts without A are currently available, but not recommended for new designs. The parts with A are preferred.

For stack-die parts, use * to label the part number.

1.5SMC Series

Surface Mount – 1500W

I-V Curve Characteristics

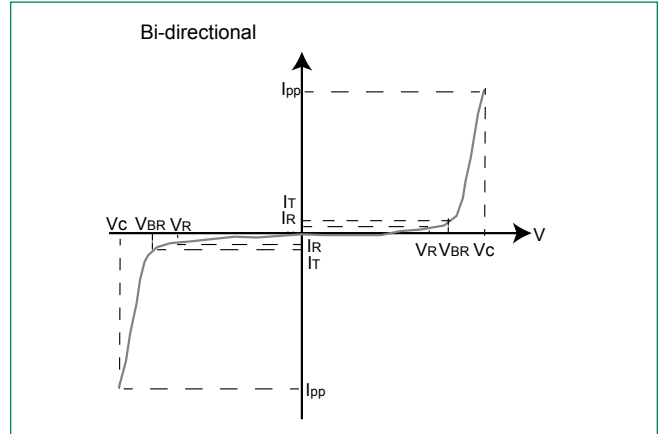
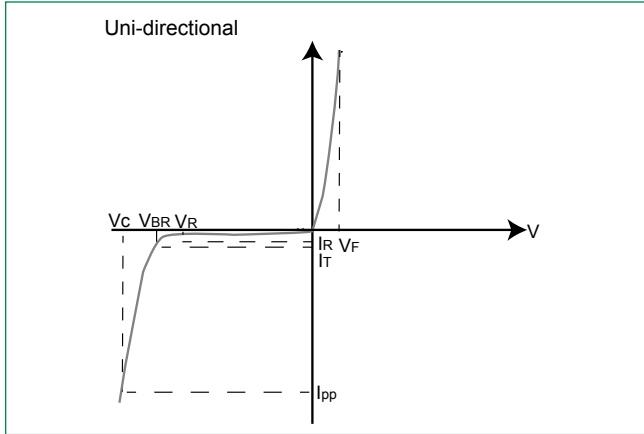

- P_{PPM} Peak Pulse Power Dissipation** -- Max power dissipation
- V_R Stand-off Voltage** -- Maximum voltage that can be applied to the TVS without operation
- V_{BR} Breakdown Voltage** -- Maximum voltage that flows though the TVS at a specified test current (I_T)
- V_C Clamping Voltage** -- Peak voltage measured across the TVS at a specified I_{ppm} (peak impulse current)
- I_R Reverse Leakage Current** -- Current measured at V_R
- V_F Forward Voltage Drop for Uni-directional**

Ratings and Characteristic Curves ($T_A=25^\circ\text{C}$ unless otherwise noted)

Figure 1: TVS Transients Clamping Waveform

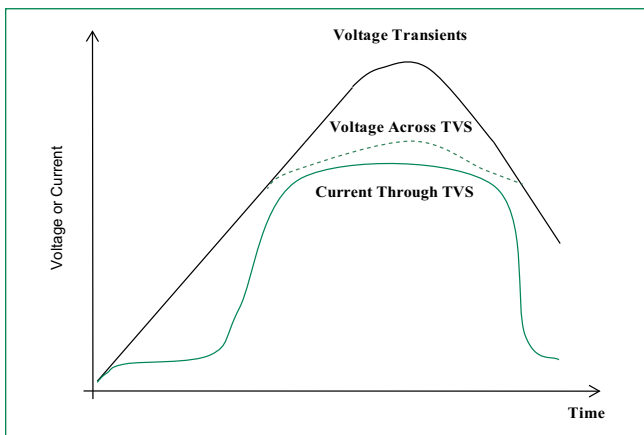
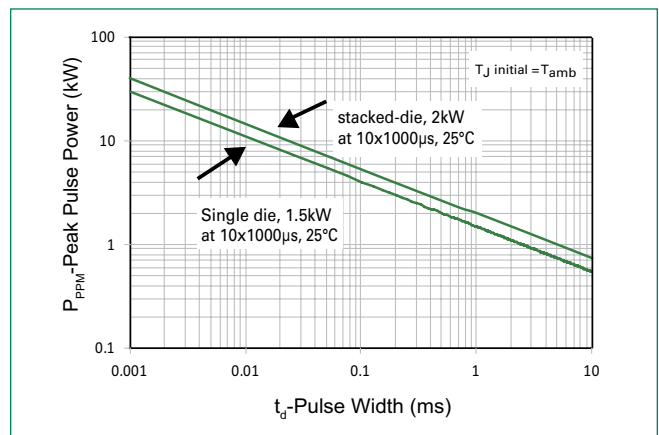

Figure 2: Peak Pulse Power Rating



1.5SMC Series

Surface Mount – 1500W

Ratings and Characteristic Curves ($T_A=25^\circ\text{C}$ unless otherwise noted) (Continued)

Figure 3: Peak Pulse Power Derating Curve

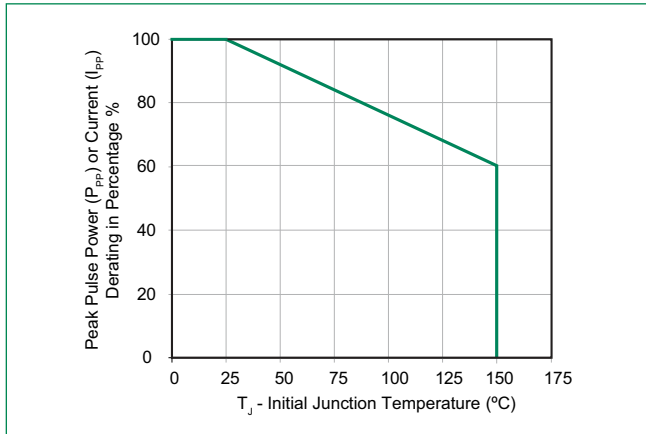

Figure 4: Pulse Waveform

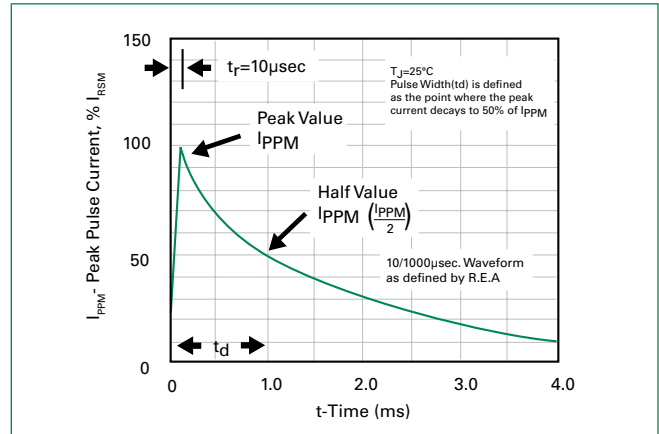

Figure 5: Typical Junction Capacitance

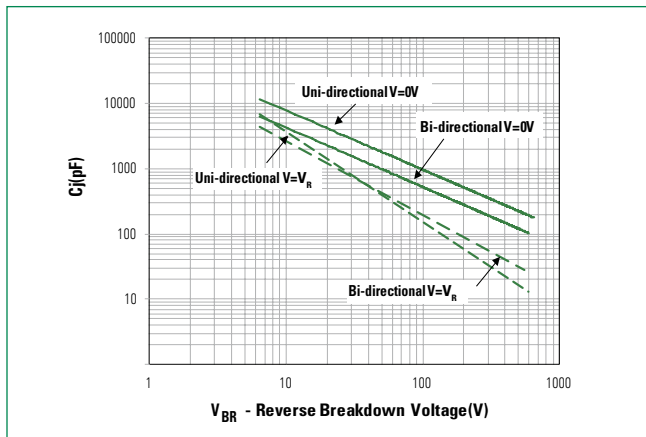

Figure 6: Typical Transient Thermal Impedance

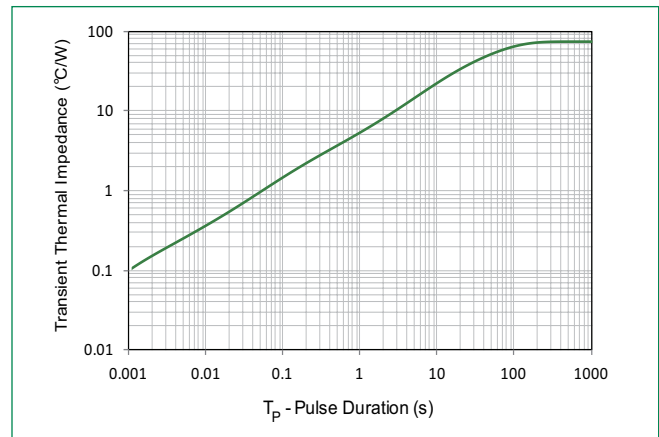

Figure 7: Maximum Non-Repetitive Peak Forward Surge Current Uni-Directional Only

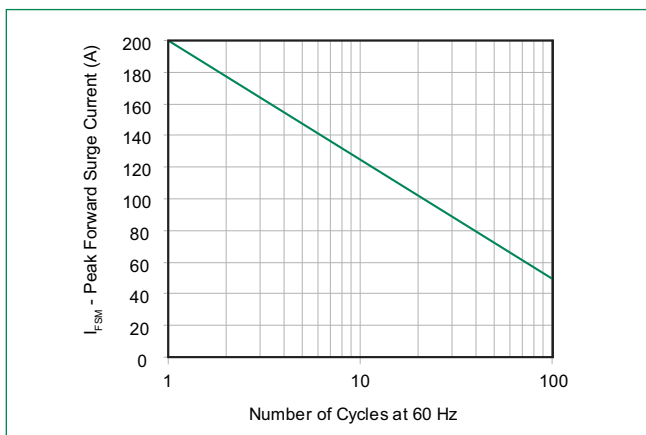
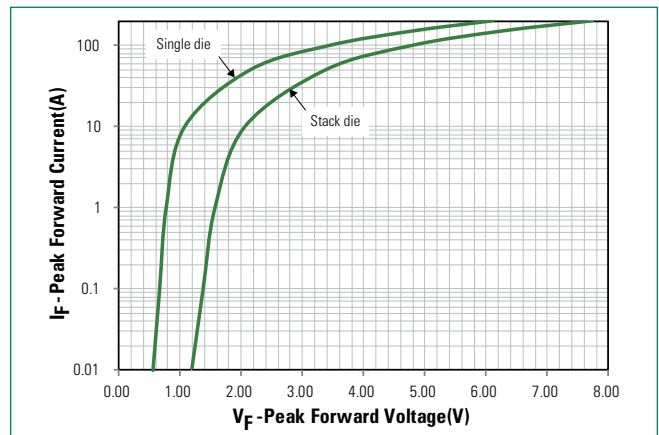

Figure 8: Peak Forward Voltage Drop vs Peak Forward Current (Typical Values)



1.5SMC Series

Surface Mount – 1500W

Soldering Parameters

| | | |
|--|------------------------------------|-------------------------|
| Reflow Condition | | Lead-free assembly |
| Pre Heat | - Temperature Min ($T_{s(min)}$) | 150°C |
| | - Temperature Max ($T_{s(max)}$) | 200°C |
| | - Time (min to max) (t_s) | 60 – 120 secs |
| Average ramp up rate (Liquidus Temp (T_L) to peak) | | 3°C/second max |
| $T_{s(max)}$ to T_L - Ramp-up Rate | | 3°C/second max |
| Reflow | - Temperature (T_L) (Liquidus) | 217°C |
| | - Time (min to max) (t_L) | 60 – 150 seconds |
| Peak Temperature (T_p) | | 260 ^{+0/-5} °C |
| Time within 5°C of actual peak Temperature (t_p) | | 30 seconds max |
| Ramp-down Rate | | 6°C/second max |
| Time 25°C to peak Temperature (T_p) | | 8 minutes Max. |
| Do not exceed | | 260°C |

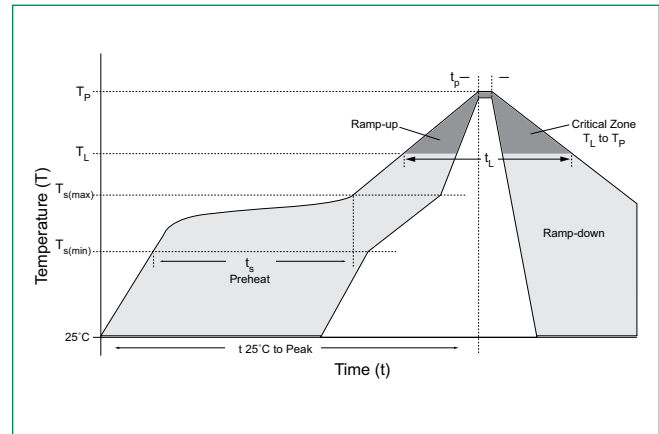

Physical Specifications

| | |
|-----------------|---|
| Weight | 0.007 ounce, 0.21 grams |
| Case | JEDEC DO214AB. Molded plastic body over glass passivated junction |
| Polarity | Color band denotes positive end (cathode) except Bidirectional. |
| Terminal | Matte Tin-plated leads, Solderable per JESD22-B102 |

Environmental Specifications

| | |
|----------------------------|--------------------------|
| High Temp. Storage | JESD22-A103 |
| HTRB | JESD22-A108 |
| Temperature Cycling | JESD22-A104 |
| MSL | JEDEC-J-STD-020, Level 1 |
| H3TRB | JESD22-A101 |
| RSH | JESD22-A111 |

Dimensions

DO-214AB (SMC J-Bend)

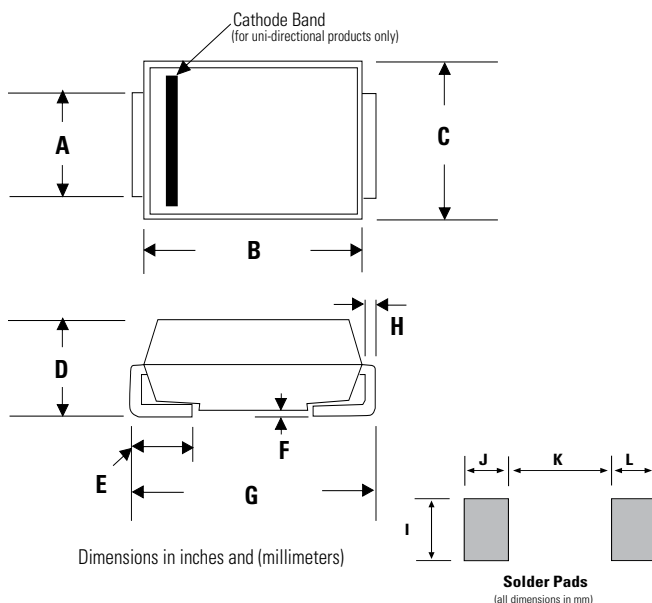

| Dimensions | Inches | | Millimeters | |
|------------|--------|-------|-------------|-------|
| | Min | Max | Min | Max |
| A | 0.114 | 0.126 | 2.900 | 3.200 |
| B | 0.260 | 0.280 | 6.600 | 7.110 |
| C | 0.220 | 0.245 | 5.590 | 6.220 |
| D | 0.079 | 0.103 | 2.060 | 2.620 |
| E | 0.030 | 0.060 | 0.760 | 1.520 |
| F | - | 0.008 | - | 0.203 |
| G | 0.305 | 0.320 | 7.750 | 8.130 |
| H | 0.006 | 0.012 | 0.152 | 0.305 |
| I | 0.129 | - | 3.300 | - |
| J | 0.094 | - | 2.400 | - |
| K | - | 0.165 | - | 4.200 |
| L | 0.094 | - | 2.400 | - |

1.5SMC Series

Surface Mount – 1500W

Part Numbering System

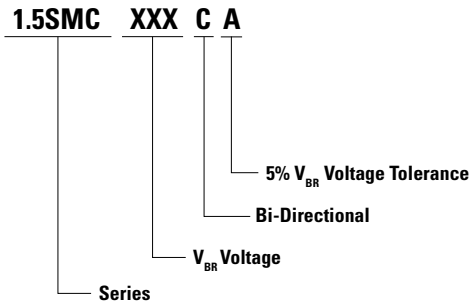

Part Marking System



Packaging

| Part number | Component Package | Quantity | Packaging Option | Packaging Specification |
|-------------|-------------------|----------|----------------------------------|-------------------------|
| 1.5SMCxxxXX | DO-214AB | 3000 | Tape & Reel - 16mm tape/13" reel | EIA STD RS-481 |

Tape and Reel Specification

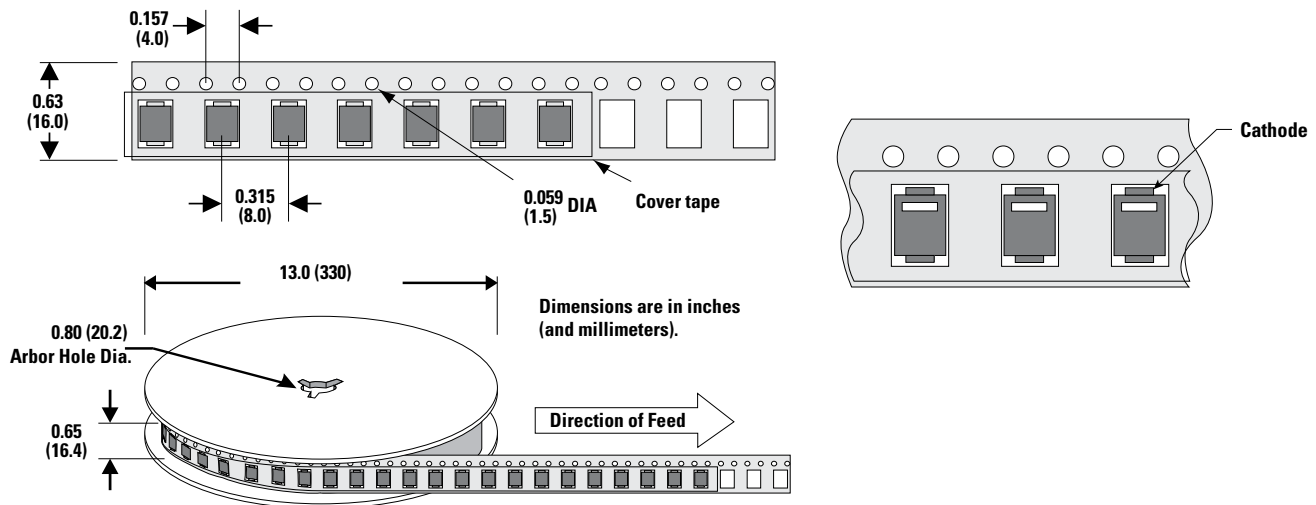

Disclaimer Notice - Littelfuse products are not designed for, and shall not be used for, any purpose (including, without limitation, automotive, military, aerospace, medical, life-saving, life-sustaining or nuclear facility applications, devices intended for surgical implant into the body, or any other application in which the failure or lack of desired operation of the product may result in personal injury, death, or property damage) other than those expressly set forth in applicable Littelfuse product documentation. Warranties granted by Littelfuse shall be deemed void for products used for any purpose not expressly set forth in applicable Littelfuse documentation. Littelfuse shall not be liable for any claims or damages arising out of products used in applications not expressly intended by Littelfuse as set forth in applicable Littelfuse documentation. The sale and use of Littelfuse products is subject to Littelfuse Terms and Conditions of Sale, unless otherwise agreed by Littelfuse. "Littelfuse" includes Littelfuse, Inc., and all of its affiliate entities. <http://www.littelfuse.com/disclaimer-electronics>.