

## M12 FEMALE 90° LED

PUR 5X0.34 black ROBOT, drag ch 20m

M12

Female 90°

5-pole with 3 × LED (PNP)

Art.-No. 7005 - M12 Lite - (plastic hexagonal screw) on request

Plastic housings with good resistance against chemicals and oils. The resistance to aggressive media should be individually tested for your application. Further details on request. Further cable lengths on request.

### [Link to Product](#)

#### Illustration

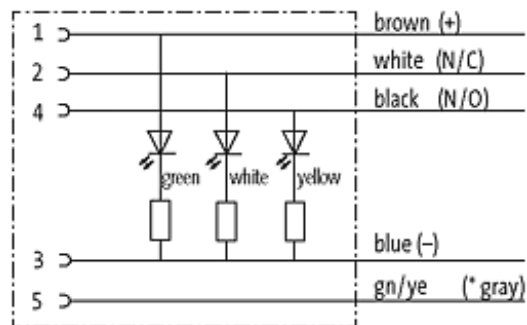
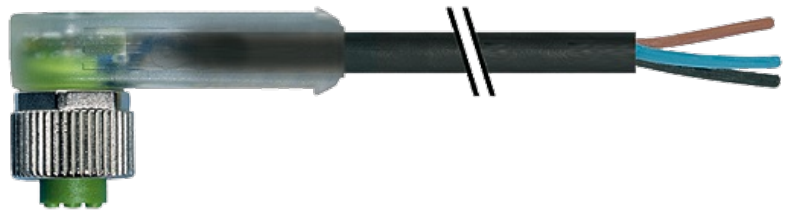

(\* for cable type 126 and 732)

# Female

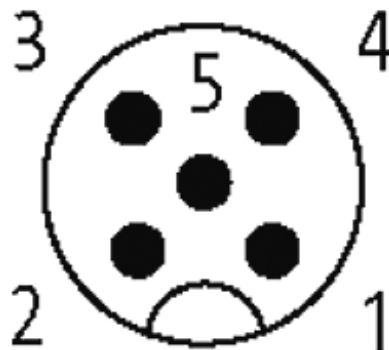

Product may differ from Image

## Approvals



\* only for products with UL/CSA approved cable

## Form

12441

## Technical Data

Operating voltage	24 V DC $\pm 25\%$
Operating current per contact	max. 4 A
Locking of ports	Screw thread M12 $\times$ 1 mm (recommended torque 0.6 Nm) self-securing
Protection	IP67 inserted and tightened (EN 60529)

## Cables

Cable number	655
--------------	-----

No./diameter of wires	5 × 0.34 mm <sup>2</sup>
Wire isolation	PP (br, wh, bl, bk, gnye)
C-track properties	10 Mio.
Torsion	1 Mio. ± 360°/m
Jacket Color	black
Shore hardness outer jacket	58 ± 3D
Material (jacket)	PUR (UL/CSA), welding spark res.
Outer diameter	approx. 5.0 mm
Bend radius (fixed)	5 × outer Ø
Bend radius (moving)	10 × outer Ø
Temperature range (fixed)	-40...+90 °C
Temperature range (mobile)	-25...+90 °C

#### Commercial data

country of origin	DE
customs tariff number	85444290
minimum order quantity	1