

MSUD VALVE PLUG FORM A 18MM

PUR 3X0.75 YELLOW, 5m

Form A (18 mm)
110 V AC/DC with LED and suppression

Further cable lengths on request. Plastic housings with good resistance against chemicals and oils. The resistance to aggressive media should be individually tested for your application. Further details on request.

[Link to Product](#)

Illustration

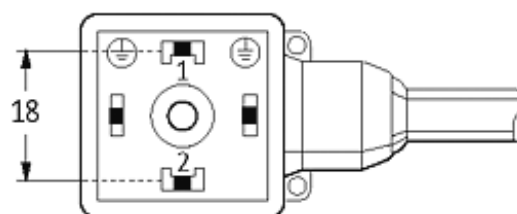
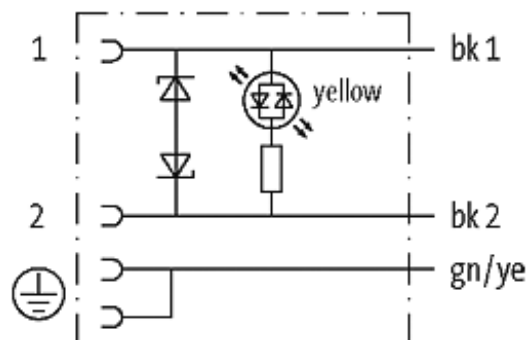



Product may differ from Image

Approvals



Form

18041

Technical Data

Operating voltage	110 V AC/DC (95...121 V AC/DC)
Operating current per contact	max. 4 A
Switch off peak	max. 250 V
Switch off delay time	max. 20 ms
Locking of ports	M3 (recommended torque 0.4 Nm)
Protection	IP67 inserted and tightened (EN 60529)
Housing	Black plastic (gray on request)

Cables

Cable number	026
No./diameter of wires	3 × 0.75 mm ²
Wire isolation	PVC (bk, num, gnye)
C-track properties	2 Mio.
Jacket Color	yellow
Shore hardness outer jacket	85 ± 5A
Material (jacket)	PUR/PVC (UL/CSA)
Outer diameter	approx. 5.9 mm
Bend radius (fixed)	10 × outer Ø
Bend radius (moving)	15 × outer Ø
Temperature range (fixed)	-30...+80 °C
Temperature range (mobile)	-5...+80 °C

General data

Temperature range	-25...+85 °C, depending on cable quality
-------------------	--

Commercial data

The information in this brochure has been compiled with the utmost care.

Liability for the correctness completeness and topicality of the information is restricted to gross negligence. Version: 05/15

Murrelektronik GmbH | Falkenstraße 3, 71570 Oppenweiler | Fon +49 (71 91) 47-0, Fax +49 (71 91) 47-491000 | shop@murrelektronik.de | shop.murrelektronik.de

country of origin	CZ
customs tariff number	85444290
minimum order quantity	1
