

M12 MALE 0° / MSUD VALVE PLUG FORM A 18MM

PVC 5X0.34 black 0.3m

Form A (18 mm) – M12, male straight
for pressure switches
LED (red/green)
5-pole

Further cable lengths on request. Plastic housings with good resistance against chemicals and oils. The resistance to aggressive media should be individually tested for your application. Further details on request.

[Link to Product](#)

Illustration

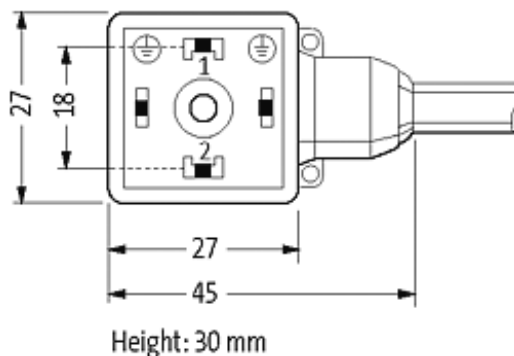
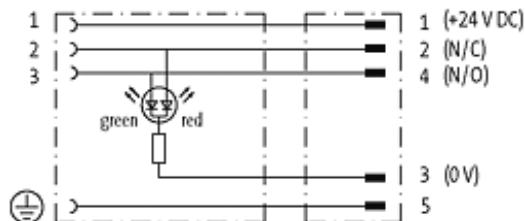

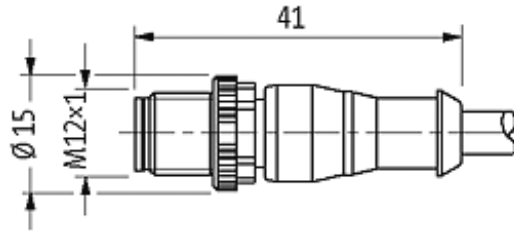

Product may differ from Image

Approvals



Technical Data

| | |
|-------------------------------|--|
| Operating voltage | 24 V DC $\pm 25\%$ |
| Operating current per contact | max. 4 A |
| Locking of ports | M3/M12 \times 1 mm (recommended torque 0.4/0.6 Nm) |
| Protection | IP67 inserted and tightened (EN 60529) |
| Housing | Black plastic (gray on request) |

Cables

| | |
|-----------------------------|---------------------------------|
| Cable number | 615 |
| No./diameter of wires | 5 \times 0.34 mm ² |
| Wire isolation | PVC (br, wh, bl, bk, gnye) |
| Jacket Color | black |
| Shore hardness outer jacket | 85 \pm 5A |
| Material (jacket) | PVC (UL/CSA) |
| Outer diameter | approx. 5.2 mm |
| Bend radius (fixed) | 5 \times outer \varnothing |
| Bend radius (moving) | 10 \times outer \varnothing |
| Temperature range (fixed) | -30...+80 °C |
| Temperature range (mobile) | -5...+80 °C |

General data

| | |
|-------------------|--|
| Temperature range | -25...+85 °C, depending on cable quality |
|-------------------|--|

Commercial data

| | |
|------------------------|----------|
| country of origin | CZ |
| customs tariff number | 85444290 |
| minimum order quantity | 1 |