



Model number

MHW 06

Modular mounting bracket

Features

- Suitable for VariKont and VariKont L Sensors
- Aluminium profile, pre-mounted
- For mounting on support profiles in conveying technology (available for different types of profiles)
- Simple and fast mounting
- The position of the sensor is adjustable in all 3 axial directions
- Sensor can be mounted length or crosswise on the profile section
- All fixing components are provided with captive screws

Application

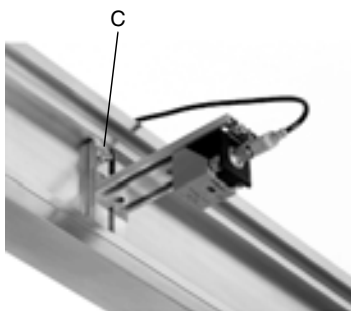

VariKont L installed on the mounting bracket

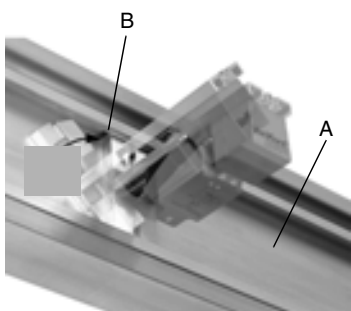

Installation of the mounting bracket on the supporting profile

Dimensions

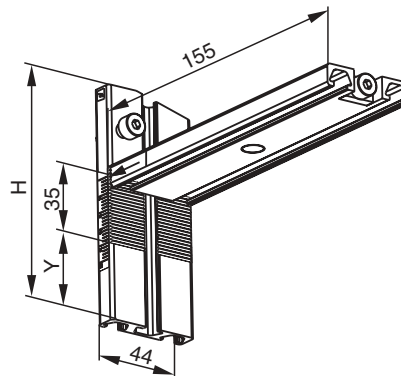

Technical data

Mechanical specifications

Material	Aluminium extruded rail profile
Dimensions	Profile rail 1 for the installation of the mounting bracket: 155 mm Profile rail 2 for positioning the mounting bracket for the supporting profile:

Profil Typ	H [mm]	Y [mm]
MHW 01	107	35
MHW 02	116	20
MHW 06	158	60
MHW 09	139	52
MHW 10	132	47

Notes

Installation

- Position the sliding block on the serrated side of profile rail 1 in the centre slot of profile rail 2.
- To form the mounting bracket, position the profiles at right angles to each other, by engaging the serrations.
- Stabilise the mounting bracket by tightening the cylindrical head screw on the end.
- Place the mounting bracket on the surface of the supporting profile (A) and twist the bracket by its ends (B) until it engages behind the flanges in the supporting profile.
- Align the mounting bracket.
- Secure the profile rail on the supporting profile by means of the clamping screw (C).
- Insert the two M5 x 18 screws (for VariKont Sensors) or M5 x 42 (for VariKont L Sensors) in the base of the sensor and pre-mount the sliding blocks.
- Insert the sliding blocks into the two grooves in the profile rail 1.
- Position the sensor as required and clamp it.

Note:

With some applications the installation is easier if the sensor is pre-mounted on the profile section before the mounting bracket is assembled and mounted on the supporting profile.

Notes

Supplied accessories

Modular mounting bracket MHW ..., consisting of

- 1 profile rail 1 (155 mm) for installation of the mounting bracket, pre-mounted with clamp, clamping plate, sliding block and cylindrical head screw (M6 x 155/DIN 912)
- 1 profile rail 2 (length H) for positioning the mounting bracket on the supporting profile, pre-mounted with sliding block and cylindrical head screw (M6 x 20 / DIN 912)
- 2 sliding blocks (M5) for the installation of the sensor
- 2 cylindrical head screws (M5 x 18/DIN 84) for VariKont Sensors
- 2 cylindrical head screws (M5 x 42/DIN 84) for VariKont L Sensors