

SIRIUS ACT: terminal module (LED module), integrated LED yellow, for front plate mounting



Figure similar

Product brand name	SIRIUS ACT
Product designation	Terminal module
Product type designation	3SU1

Display

Display version	
<ul style="list-style-type: none"> for diagnostic function: Supply voltage monitoring Power LED 	Yes
<ul style="list-style-type: none"> status Tx/Rx link 	No

General technical data

Product function	
<ul style="list-style-type: none"> Reverse polarity protection 	Yes; Ribbon cable can be rotated 180°.
<ul style="list-style-type: none"> Diagnostics function 	Yes
Firmware version	1.0.0
Hardware version	1
Software version with STEP 7 in the TIA Portal required	V13 SP1 (V13 SP1 and V14 with HSP0132)
Power loss [W] typical	0.115 W

Degree of pollution	3
Type of voltage	
• of the operating voltage	DC
• of the input voltage	DC
Surge voltage resistance rated value	0.8 kV
Consumed current	
• maximum	27 mA
• Rated value	23 mA
Protection class IP	IP20
Equipment marking acc. to DIN EN 81346-2	K

Communication/ Protocol

Protocol is supported	
• PROFI-safe protocol	No

Connections/Terminals

Type of electrical connection	Insulation displacement connection
Type of connectable conductor cross-sections	Ribbon cable 7-pole, 7 x 0.08 mm ²
Connectable conductor cross-section for auxiliary contacts	
• single or multi-stranded	0.08 ... 0.08 mm ²
• finely stranded with core end processing	0.08 mm ²
Connectable conductor cross-section	
• solid	0.08 ... 0.08 mm ²
• solid with core end processing	0.08 ... 0.08 mm ²
• finely stranded with core end processing	0.08 ... 0.08 mm ²
• finely stranded without core end processing	0.08 ... 0.08 mm ²
AWG number as coded connectable conductor cross section	28 ... 28

Lamp

Color of the light source	yellow
----------------------------------	--------

Safety related data

Service life maximum	20 y
-----------------------------	------



Ambient conditions

Ambient temperature	
• during operation	-25 ... +60 °C
• during storage	-40 ... +80 °C
Environmental category during operation acc. to IEC 60721	3M6, 3S2, 3B2, 3K6 (with relative air humidity of 10 ... 95 %, no condensation in operation permitted)
Explosion protection marking for intrinsic safety of related equipment EEx ia	No
Explosion protection marking for intrinsic safety of related equipment EEx ib	No

Installation/ mounting/ dimensions

Mounting type of modules and accessories	Snap-on mounting
Height	32.6 mm
Width	30 mm
Depth	31.5 mm

Certificates/approvals

General Product Approval	Declaration of Conformity	Test Certificates	other
 UL		 EG-Konf.	Declaration of the Compliance with the order Special Test Certificate Confirmation

Further information

Information- and Downloadcenter (Catalogs, Brochures,...)

<http://www.siemens.com/industrial-controls/catalogs>

Industry Mall (Online ordering system)

<https://mall.industry.siemens.com/mall/en/en/Catalog/product?mlfb=3SU1401-1ME30-1DA1>

Cax online generator

<http://support.automation.siemens.com/WW/CAXorder/default.aspx?lang=en&mlfb=3SU1401-1ME30-1DA1>

Service&Support (Manuals, Certificates, Characteristics, FAQs,...)

<https://support.industry.siemens.com/cs/ww/en/ps/3SU1401-1ME30-1DA1>

Image database (product images, 2D dimension drawings, 3D models, device circuit diagrams, EPLAN macros, ...)

http://www.automation.siemens.com/bilddb/cax_de.aspx?mlfb=3SU1401-1ME30-1DA1&lang=en

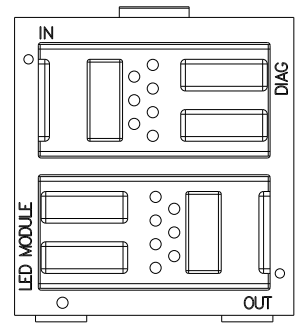
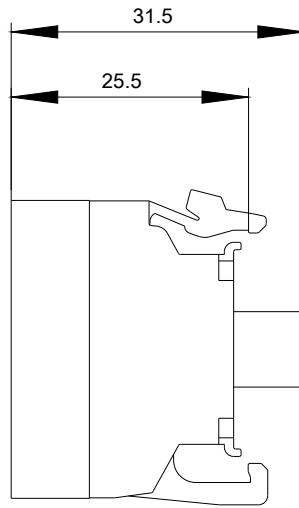
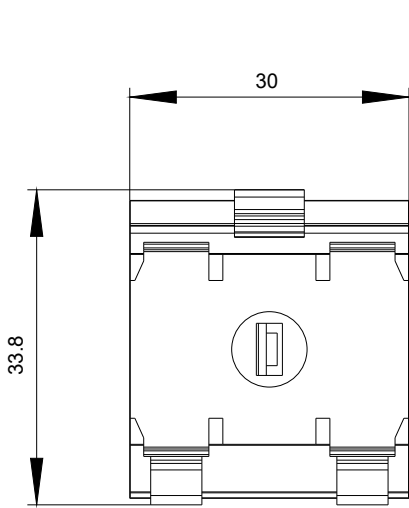

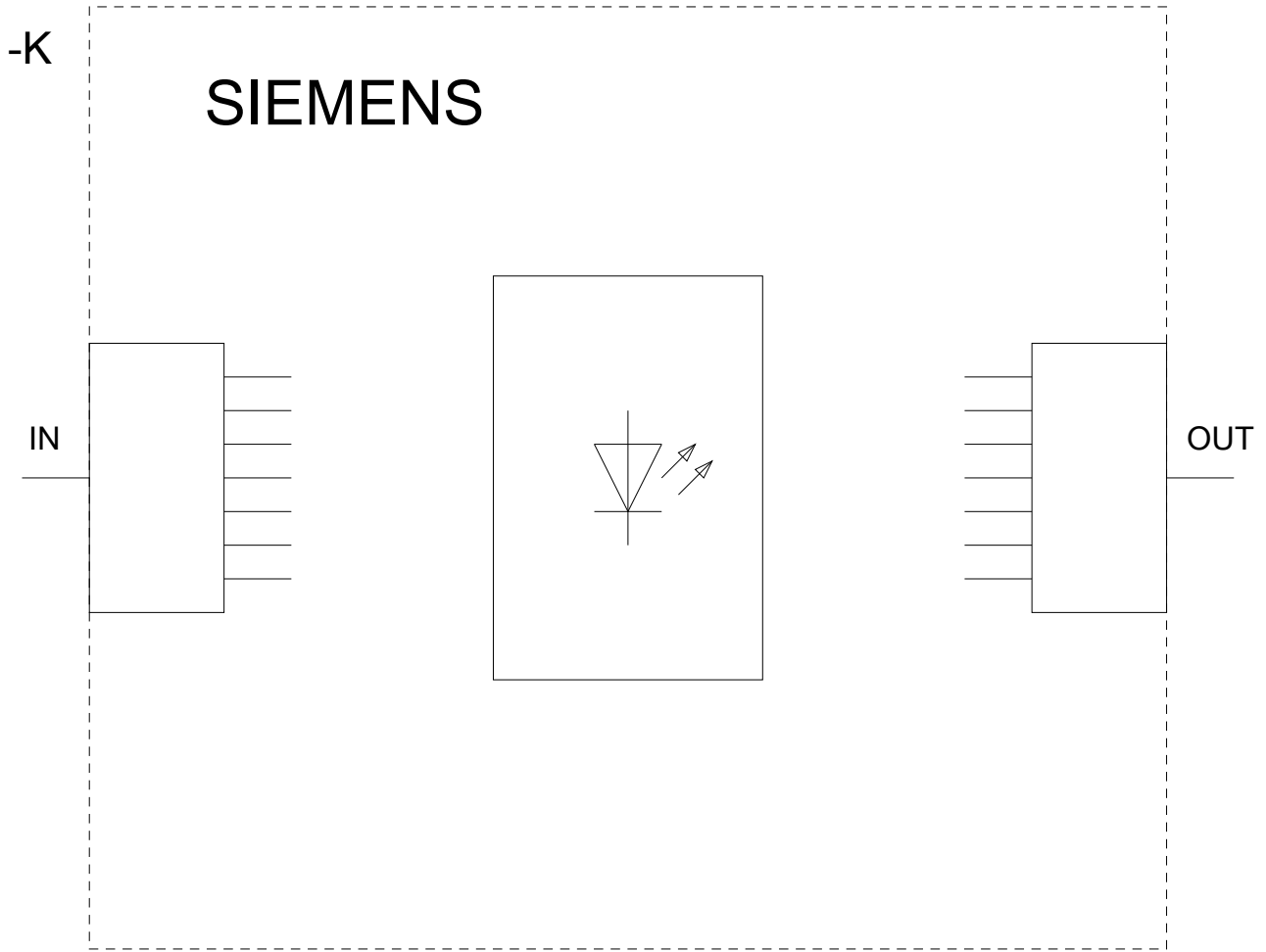

last modified:

09/25/2017