

PLEASE CHECK WWW.MOLEX.COM FOR LATEST PART INFORMATION

Part Number: [0353620550](#)
Status: **Active**
Overview: [Sherlock Connector System](#)
Description: 2.00mm Pitch Sherlock Wire-to-Board Header, Vertical, with Positive Lock, 5 Circuits, with Kinked PC Tails, Natural

Documents:

[3D Model](#) [Packaging Specification PK-35362-001 \(PDF\)](#)
[Drawing \(PDF\)](#) [RoHS Certificate of Compliance \(PDF\)](#)
[Product Specification PS-35507-003-001 \(PDF\)](#)

Agency Certification

CSA LR19980
 UL E29179

General

Product Family PCB Headers
 Series [35362](#)
 Application Signal, Wire-to-Board
 Overview [Sherlock Connector System](#)
 Product Name Sherlock
 UPC 822348259540

Physical

Breakaway No
 Circuits (Loaded) 5
 Circuits (maximum) 5
 Color - Resin Natural
 Durability (mating cycles max) 30
 First Mate / Last Break No
 Flammability 94V-0
 Glow-Wire Capable No
 Guide to Mating Part No
 Keying to Mating Part None
 Lock to Mating Part Yes
 Mated Height 8.50mm
 Material - Plating Mating Tin
 Material - Plating Termination Tin
 Material - Resin Nylon
 Net Weight 0.339/g
 Number of Rows 1
 Orientation Vertical
 PC Tail Length 3.30mm
 PCB Locator No
 PCB Retention Yes
 PCB Thickness - Recommended 1.60mm
 Packaging Type Bag
 Pitch - Mating Interface 2.00mm
 Pitch - Termination Interface 2.00mm
 Polarized to Mating Part Yes
 Polarized to PCB No
 Shrouded Partial
 Stackable No
 Surface Mount Compatible (SMC) No
 Temperature Range - Operating -40° to +105°C
 Termination Interface: Style Through Hole

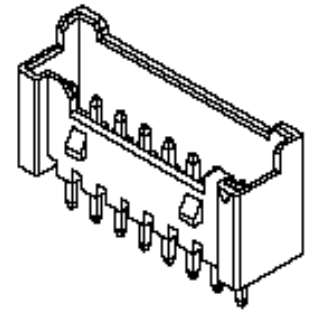

Series image - Reference only

EU ELV

Not Relevant

EU RoHS

Compliant

REACH SVHC

Not Contained Per -
 ED/61/2018 (27 June
 2018)

Halogen-Free

Status

Low-Halogen

For more information, please visit [Contact US](#)

China ROHS

ELV

RoHS Phthalates

China RoHS

Green Image

Not Relevant

Not Contained

Search Parts in this Series

[35362](#) Series

Mates With

[35507](#) Sherlock Wire-to-Board Housing

Use With

[50212-8000](#) Terminal

Electrical

Current - Maximum per Contact 2.0A
Voltage - Maximum 125V

Material Info**Reference - Drawing Numbers**

Packaging Specification PK-35362-001
Product Specification PS-35507-003-001
Sales Drawing SD-35362-002-001, SD-35362-002-002

This document was generated on 10/24/2018

PLEASE CHECK WWW.MOLEX.COM FOR LATEST PART INFORMATION