

EBC025

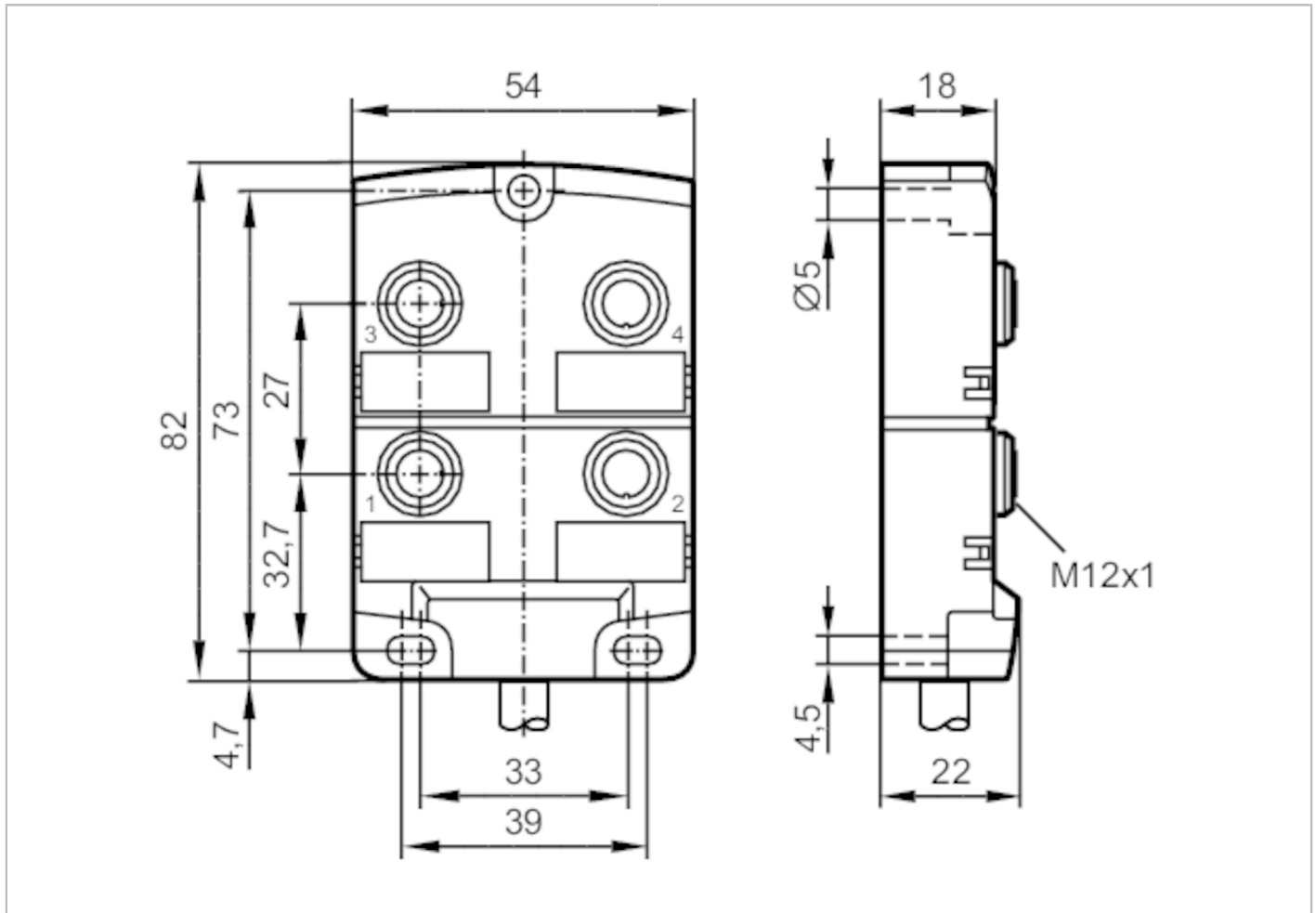

Splitter box

ZDO4H050MSS0010H07



Application	
Special feature	Free from silicone; Halogen-free; Gold-plated contacts; Drag chain suitability
Free from silicone	yes
Electrical data	
Operating voltage [V]	< 30 AC/DC; ("supply class 2" to cULus)
Protection class	II
Max. current load per module/slot [A]	4
Max. current load total [A]	12
Operating conditions	
Ambient temperature [°C]	-25...80
Ambient temperature (moving) [°C]	-5...60
Protection	IP 67; IP 68; ("enclosure type 1" according to cULus)

EBC025



Splitter box

ZDO4H050MSS0010H07

Mechanical data		
Weight [g]	937	
Dimensions [mm]	18 x 54 x 82	
Materials	PA	
Number of ports splitter box	4	
Connector type	M12	
Drag chain suitability	yes	
Drag chain suitability	bending radius for flexible use	min. 10 x cable diameter
	bending cycles	> 2 Mio.
Accessories		
Accessories (supplied)	Protective caps: 2	
	labels: 4	
Remarks		
Pack quantity	1 pcs.	
Electrical connection		
Cable: 10 m, PUR, Halogen-free, black, Ø 7.5 mm; 4 x 0.34 mm ² (43 x Ø 0.1 mm) + 3 x 1 mm ² (55 x Ø 0.15 mm)		
Electrical connection - slot		
Connector: 4 x M12; Moulded body: PA; Contacts: gold-plated; Tightening torque: 0.8...1.5 Nm		



Splitter box

ZDO4H050MSS0010H07

Connection

<u>BN</u>	1 (1...4)	C
<u>BU</u>	3 (1...4)	C
<u>GN/YE</u>	5 (1...4)	C
<u>WH</u>	4 (1)	C
<u>GN</u>	4 (2)	C
<u>YE</u>	4 (3)	C
<u>GY</u>	4 (4)	C

Core colours :

BN =	brown
BU =	blue
GN =	green
GY =	grey
WH =	white
YE =	yellow