

650 V power Schottky silicon carbide diode

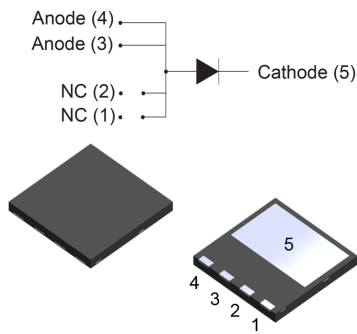

PowerFLAT™ 8x8 HV

Features

- Less-than-1mm height package
- High creepage package
- No or negligible reverse recovery
- Temperature independent switching behavior
- High forward surge capability
- Low drop forward voltage
- Power efficient product
- ECOPACK®2 compliant component

Applications

- Switch mode power supply
- Boost PFC
- Bootstrap diode
- LLC clamping function
- High frequency inverter applications

Description

This 4 A, 650 V, SiC diode is an ultra-high performance power Schottky diode. It is manufactured using a silicon carbide substrate. The wide band gap material allows the design of a Schottky diode structure with a 650 V rating. Due to the Schottky construction, no recovery is shown at turn-off and ringing patterns are negligible. The minimal capacitive turn-off behavior is independent of temperature.

Qualified in low profile package, the STPSC4H065DLF in PowerFLAT™8x8 HV, enables low drop forward voltage associated to high surge capabilities in low space environment such as Telecom & Network, Industrial or Renewable energy domains.

Product status link

[STPSC4H065DLF](#)

Product summary

Symbol	Value
$I_{F(AV)}$	4 A
V_{RRM}	650 V
$V_{F(typ.)}$	1.38 V
$T_{j(max.)}$	175 °C

Product label



1 Characteristics

Table 1. Absolute ratings (limiting values at 25 °C unless otherwise specified)

Symbol	Parameter		Value	Unit
V_{RRM}	Repetitive peak reverse voltage	$T_j = -40\text{ °C to } +175\text{ °C}$	650	V
$I_{F(RMS)}$	Forward rms current		11	A
$I_{F(AV)}$	Average forward current	$T_c = 140\text{ °C}^{(1)}$, DC	4	A
I_{FSM}	Surge non repetitive forward current	$t_p = 10\text{ ms sinusoidal}$, $T_c = 25\text{ °C}$	38	A
		$t_p = 10\text{ ms sinusoidal}$, $T_c = 125\text{ °C}$	35	
		$t_p = 10\text{ }\mu\text{s square}$, $T_c = 25\text{ °C}$	400	
I_{FRM}	Repetitive peak forward current	$T_c = 140\text{ °C}^{(1)}$, $T_j = 175\text{ °C}$, $\delta = 0.1$	17	A
T_{stg}	Storage temperature range		-55 to +175	°C
T_j	Operating junction temperature range		-40 to +175	°C

1. Value based on $R_{th(j-c)}$ max.

Table 2. Thermal resistance parameters

Symbol	Parameter	Typ. value	Max. value	Unit
$R_{th(j-c)}$	Junction to case	2.6	3.9	°C/W

Table 3. Static electrical characteristics

Symbol	Parameter	Test conditions		Min.	Typ.	Max.	Unit
		T_j	V_R				
$I_R^{(1)}$	Reverse leakage current	$T_j = 25\text{ °C}$	$V_R = V_{RRM}$	-	3	40	μA
		$T_j = 150\text{ °C}$		-	35	170	
$V_F^{(2)}$	Forward voltage drop	$T_j = 25\text{ °C}$	$I_F = 4\text{ A}$	-	1.38	1.55	V
		$T_j = 150\text{ °C}$		-	1.60	1.95	

1. $t_p = 10\text{ ms}$, $\delta < 2\%$

2. $t_p = 500\text{ }\mu\text{s}$, $\delta < 2\%$

To evaluate the conduction losses, use the following equation:

$$P = 1.00 \times I_{F(AV)} + 0.237 \times I_{F(RMS)}^2$$

For more information, please refer to the following application notes related to the power losses:

- AN604 : Calculation of conduction losses in a power rectifier
- AN4021 : Calculation of reverse losses on a power diode

Table 4. Dynamic electrical characteristics

Symbol	Parameter	Test conditions	Typ.	Unit
$Q_{cj}^{(1)}$	Total capacitive charge	$V_R = 400 \text{ V}$	14.3	nC
C_j	Total capacitance	$V_R = 0 \text{ V}, T_c = 25 \text{ }^\circ\text{C}, F = 1 \text{ MHz}$	245	pF
		$V_R = 400 \text{ V}, T_c = 25 \text{ }^\circ\text{C}, F = 1 \text{ MHz}$	25	

1. Most accurate value for the capacitive charge:

$$Q_{cj}(V_R) = \int_0^{V_R} C_j(V) dV$$

1.1 Characteristics (curves)

Figure 1. Forward voltage drop versus forward current (typical values, low level)

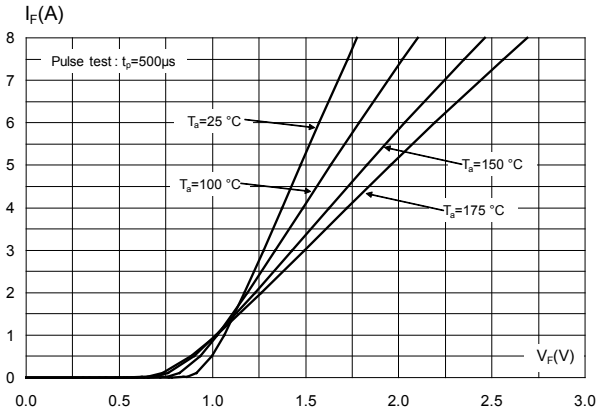

Figure 2. Forward voltage drop versus forward current (typical values, high level)

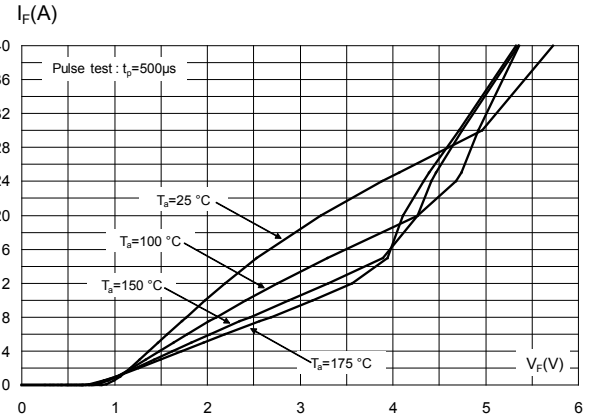

Figure 3. Reverse leakage current versus reverse voltage applied (typical values)

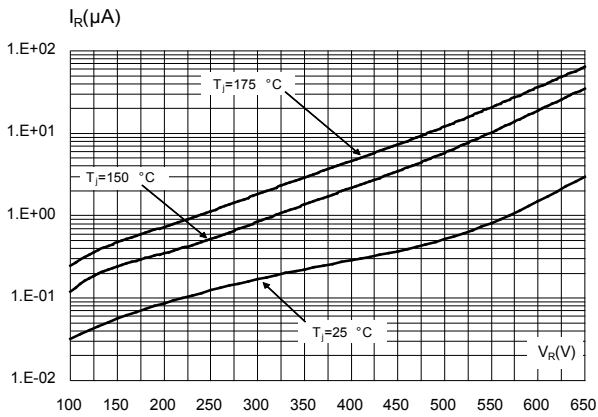

Figure 4. Peak forward current versus case temperature

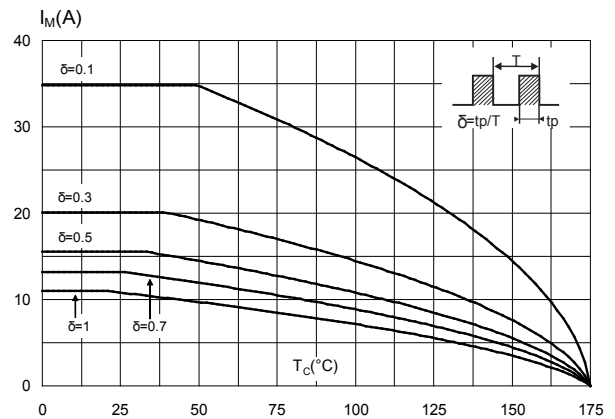
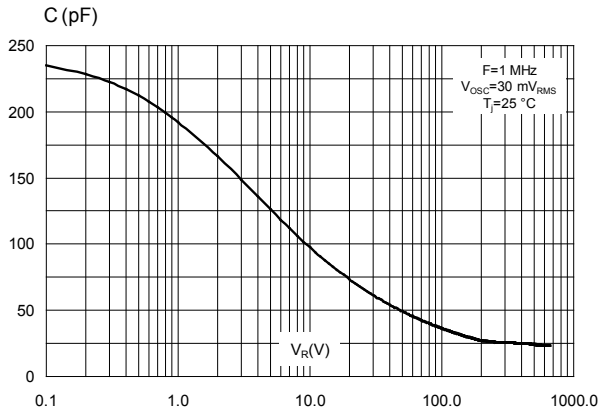
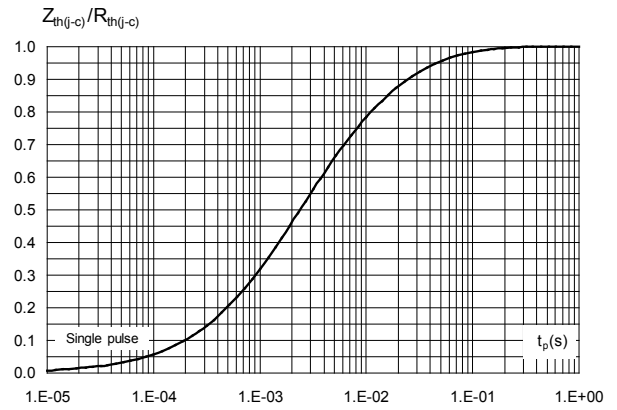
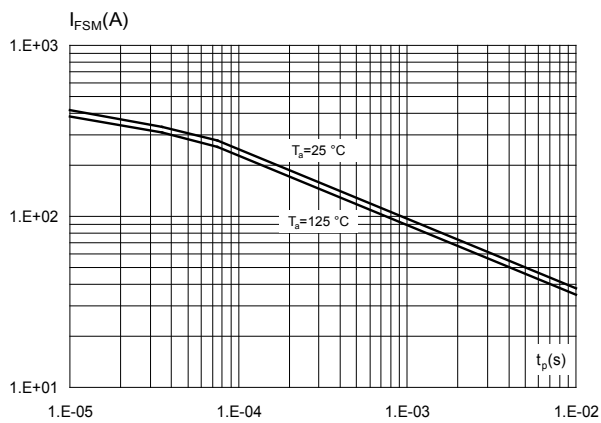
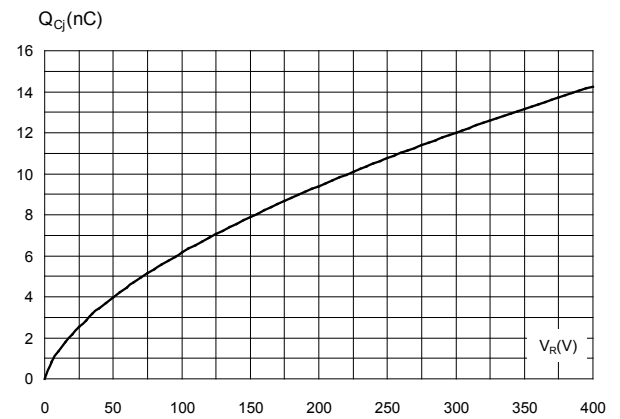

Figure 5. Junction capacitance versus reverse voltage applied (typical values)

Figure 6. Relative variation of thermal impedance junction to case versus pulse duration

Figure 7. Non-repetitive peak surge forward current versus pulse duration (sinusoidal waveform)

Figure 8. Total capacitive charges versus reverse voltage applied (typical values)

2 Package information

In order to meet environmental requirements, ST offers these devices in different grades of **ECOPACK®** packages, depending on their level of environmental compliance. ECOPACK® specifications, grade definitions and product status are available at: www.st.com. ECOPACK® is an ST trademark.

2.1 PowerFLAT™ 8x8 HV package information

- Epoxy meets UL94, V0
- Lead-free Package

Figure 9. PowerFLAT™ 8x8 HV package outline

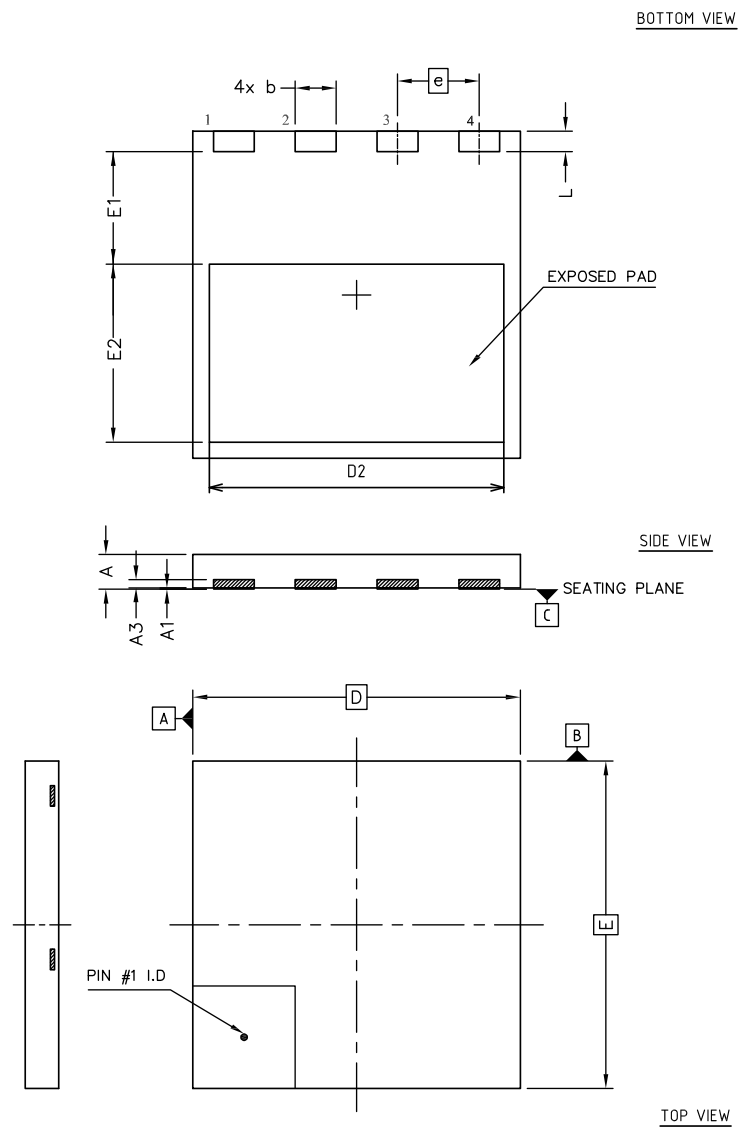
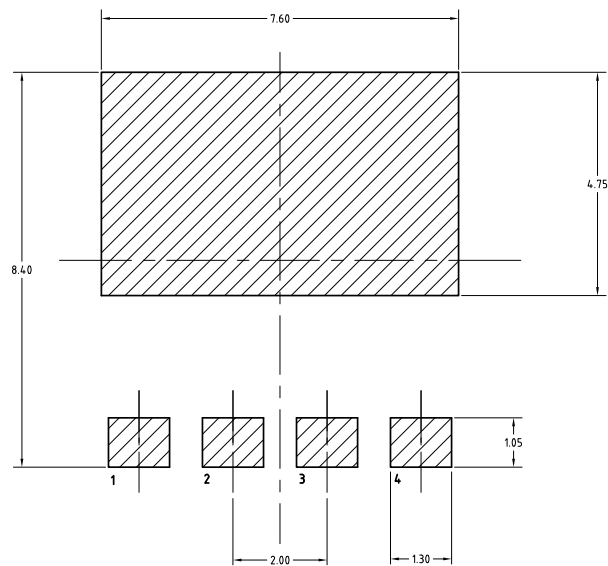

Table 5. PowerFLAT™ 8x8 HV mechanical data

Ref.	Dimensions (in mm)		
	Min.	Typ.	Max.
A	0.75	0.85	0.95
A1	0.00		0.05
A3	0.10	0.20	0.30
b	0.90	1.00	1.10
D	7.90	8.00	8.10
E	7.90	8.00	8.10
D2	7.10	7.20	7.30
E1	2.65	2.75	2.85
E2	4.25	4.35	4.45
e	2.00		
L	0.40	0.50	0.60

Figure 10. PowerFLAT™ 8x8 HV footprint



Note: All dimensions are in millimeters.

2.2 PowerFLAT™ 8x8 HV packing information

Figure 11. PowerFLAT™ 8x8 HV tape

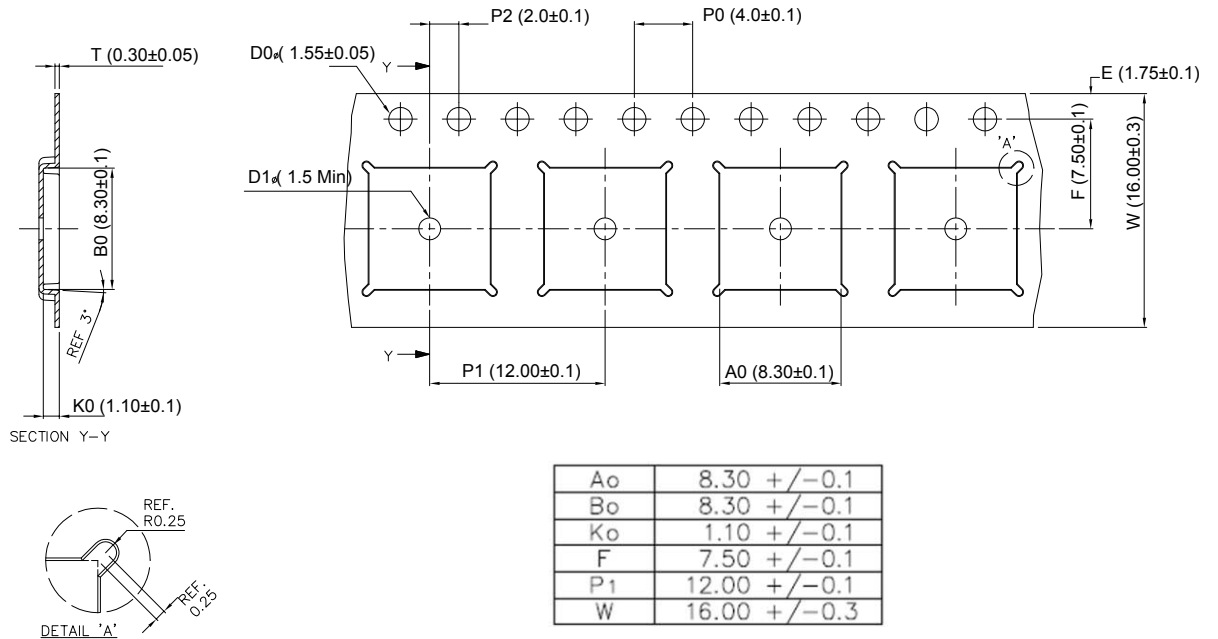

Note: All dimensions are in millimeters.

Figure 12. PowerFLAT™ 8x8 HV package orientation in carrier tape

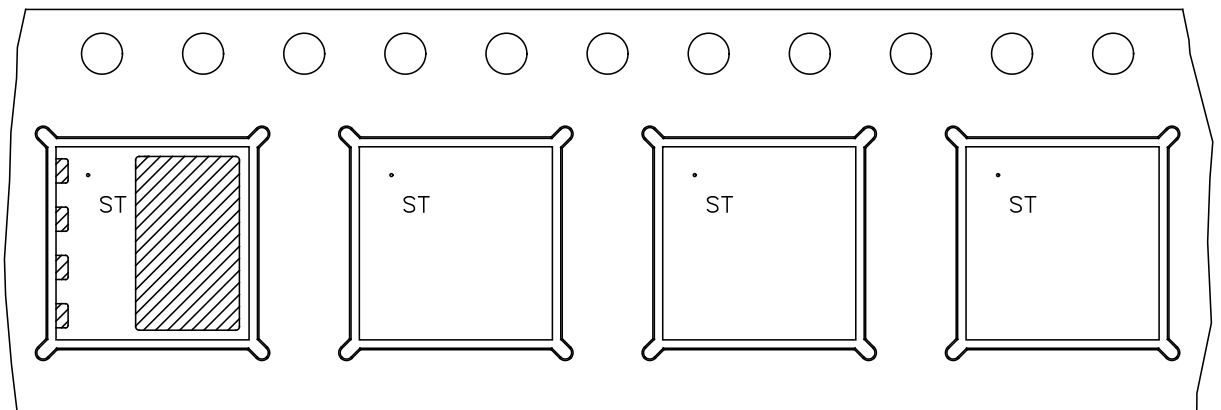

3 Ordering Information

Table 6. Ordering information

Order code	Marking	Package	Weight	Base qty.	Delivery mode
STPSC4H065DLF-TR	PSC4H065	PowerFLAT™ 8x8 HV	170 mg	3000	Reel

Revision history

Table 7. Document revision history

Date	Version	Changes
29-Nov-2018	1	Initial release.

IMPORTANT NOTICE – PLEASE READ CAREFULLY

STMicroelectronics NV and its subsidiaries (“ST”) reserve the right to make changes, corrections, enhancements, modifications, and improvements to ST products and/or to this document at any time without notice. Purchasers should obtain the latest relevant information on ST products before placing orders. ST products are sold pursuant to ST’s terms and conditions of sale in place at the time of order acknowledgement.

Purchasers are solely responsible for the choice, selection, and use of ST products and ST assumes no liability for application assistance or the design of Purchasers’ products.

No license, express or implied, to any intellectual property right is granted by ST herein.

Resale of ST products with provisions different from the information set forth herein shall void any warranty granted by ST for such product.

ST and the ST logo are trademarks of ST. All other product or service names are the property of their respective owners.

Information in this document supersedes and replaces information previously supplied in any prior versions of this document.

© 2018 STMicroelectronics – All rights reserved