

Material
 Arbeitsdruck max.
 Betriebstemperatur

Messing, vernickelt
 18 bar
 -20 °C bis 80 °C (NBR O-Ring)
 -20 °C bis 130 °C (FKM O-Ring)
 -20 °C bis 300 °C (ohne Dichtung)

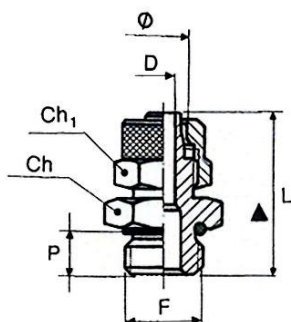

11.114-8

Gerade Einschraubverschraubungen, Außengewinde zylindrisch mit O-Ring (NBR)

Artikel Nr.	Typen Nr.	für Schlauch mm	Gewinde F	Ch mm	Ch1 mm	P mm	L mm	D mm	O-Ring mm
110468	11.105-4	4/2	M5	9	9	4,0	23,0	1,5	4x1,5
110469	11.105-5	5/3	M5	8	8	4,0	20,0	2,0	ohne
110470	11.105-6	6/4	M5	9	9	4,0	23,0	2,7	4x1,5
110471	11.118-5	5/3	G 1/8	14	8	6,0	23,0	2,0	ohne
110472	11.118-6	6/4	G 1/8	13	12	6,0	25,0	3,0	7,66x1,78
110473	11.118-8	8/6	G 1/8	14	14	6,0	25,0	5,0	7,66x1,78
110474	11.118-10	10/8	G 1/8	14	16	6,0	27,0	6,8	ohne
110475	11.114-6	6/4	G 1/4	16	12	8,0	27,0	3,0	10,82x1,78
110476	11.114-8	8/6	G 1/4	16	14	8,0	27,0	5,0	10,82x1,78
110477	11.114-10	10/8	G 1/4	16	16	8,0	29,0	6,8	10,82x1,78
110478	11.138-6	6/4	G 3/8	19	12	9,0	29,0	3,0	ohne
110479	11.138-8	8/6	G 3/8	19	14	9,0	29,0	5,0	14,00x1,78
110480	11.138-10	10/8	G 3/8	19	16	9,0	31,0	6,8	14,00x1,78
110481	11.138-12	12/10	G 3/8	19	19	9,0	33,0	8,5	14,00x1,78
110482	11.112-6	6/4	G 1/2	24	10	10,0	32,0	-	keine Maßangabe
110483	11.112-8	8/6	G 1/2	24	12	10,0	32,0	-	keine Maßangabe
110484	11.112-10	10/8	G 1/2	24	16	11,0	33,0	6,8	17,13x2,62
110485	11.112-12	12/10	G 1/2	24	19	11,0	35,0	8,5	17,13x2,62

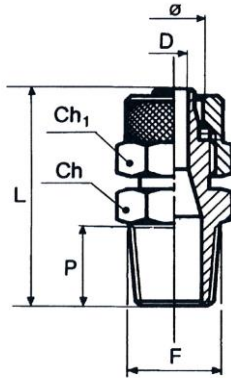

11.614-8

Gerade Einschraubverschraubungen, Außengewinde konisch, Gewinde nach ISO 7-1

Artikel Nr.	Typen Nr.	für Schlauch mm	Gewinde F	Ch mm	Ch1 mm	P mm	L mm	D mm
110486	11.618-4	4/2	R 1/8	10	10	8,0	41,0	1,3
110487	11.618-5	5/3	R 1/8	12	9	8,0	25,0	2,0
110488	11.618-6	6/4	R 1/8	12	12	8,0	26,5	3,0
110489	11.618-8	8/6	R 1/8	12	14	8,0	26,5	5,0
110490	11.618-10	10/8	R 1/8	14	16	8,0	29,5	6,0
110491	11.614-6	6/4	R 1/4	14	12	11,0	30,0	3,0
110492	11.614-8	8/6	R 1/4	14	14	11,0	30,0	5,0
110493	11.614-10	10/8	R 1/4	14	16	11,0	32,0	6,8
110494	11.638-6	6/4	R 3/8	17	12	11,5	31,5	3,0
110495	11.638-8	8/6	R 3/8	17	14	11,5	31,0	5,0
110496	11.638-10	10/8	R 3/8	17	16	11,5	33,0	6,8
110497	11.638-12	12/10	R 3/8	17	19	11,5	35,0	8,5
110498	11.612-8	8/6	R 1/2	22	14	14,0	34,5	5,0
110499	11.612-10	10/8	R 1/2	22	16	14,0	36,0	6,8
110500	11.612-12	12/10	R 1/2	22	19	14,0	38,0	8,5

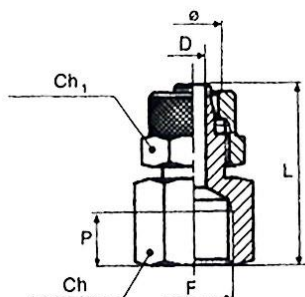

11.514-8



11.538-6

Gerade Aufsraubverschraubungen, Innengewinde

Artikel Nr.	Typen Nr.	für Schlauch mm	Gewinde F	Ch mm	Ch1 mm	P mm	L mm	D mm
110501	11.518-6	6/4	G 1/8	14	12	7,0	26,5	3,0
110502	11.518-8	8/6	G 1/8	14	14	7,0	26,5	5,0
110503	11.514-6	6/4	G 1/4	17	12	8,0	29,5	3,0
110504	11.514-8	8/6	G 1/4	17	14	8,0	29,0	5,0
110505	11.514-10	10/8	G 1/4	17	16	8,0	31,0	6,8
110506	11.538-6	6/4	G 3/8	20	12	11,5	29,5	3,0
110507	11.538-8	8/6	G 3/8	20	14	10,0	33,0	5,0
110508	11.538-10	10/8	G 3/8	20	16	10,0	35,0	6,8
110509	11.538-12	12/10	G 3/8	20	18	11,5	32,5	8,5
110510	11.512-8	8/6	G 1/2	24	12	15,5	30,0	-
110511	11.512-10	10/8	G 1/2	24	16	11,0	38,0	6,8

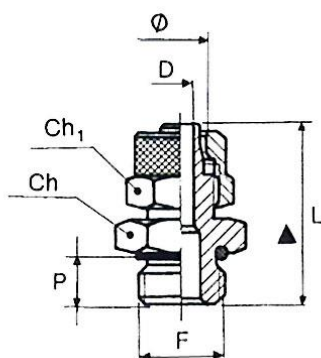

11.114-8-V

Gerade Einschraubverschraubungen, Außengewinde zylindrisch mit O-Ring (FKM)

Artikel Nr.	Typen Nr.	für Schlauch mm	Gewinde F	Ch mm	Ch1 mm	P mm	L mm	D mm	O-Ring mm
110512	11.118-6-V	6/4	G 1/8	13	12	6,0	25,0	3,0	7,66x1,78
110513	11.118-8-V	8/6	G 1/8	14	14	6,0	25,0	5,0	7,66x1,78
110514	11.114-6-V	6/4	G 1/4	16	12	8,0	27,0	3,0	10,82x1,78
110515	11.114-8-V	8/6	G 1/4	16	14	8,0	27,0	5,0	10,82x1,78
110516	11.114-10-V	10/8	G 1/4	16	16	8,0	29,0	6,8	10,82x1,78

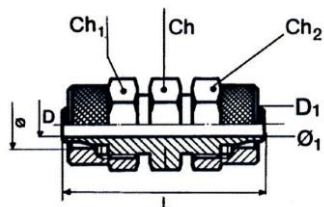

11.300-8

Gerade Verbinder

Artikel Nr.	Typen Nr.	für Schlauch 1 mm	für Schlauch 2 mm	Ch mm	Ch1 mm	Ch2 mm	L mm	D mm
110517	11.300-4	4/2	4/2	10	10	10	41,0	1,3
110518	11.300-5	5/3	5/3	8	8	8	28,5	2,0
110519	11.300-6	6/4	6/4	12	12	12	33,0	3,0
110520	11.300-8	8/6	8/6	12	14	14	33,0	5,0
110521	11.300-10	10/8	10/8	14	16	16	37,0	6,8
110522	11.300-12	12/10	12/10	17	19	19	42,0	8,5

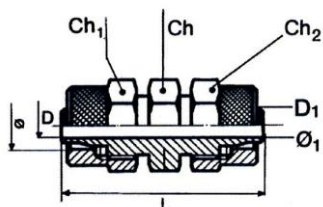

11.300-86

Gerade Verbinder, reduzierend

Artikel Nr.	Typen Nr.	für Schlauch mm	für Schlauch 1 mm	Ch mm	Ch1 mm	Ch2 mm	L mm	D mm
110523	11.300-86	8/6	6/4	14	12	14	35,0	3,0

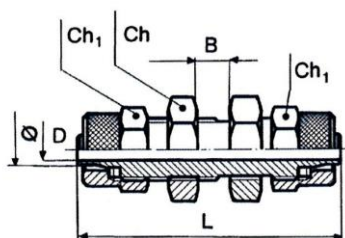

12.500-8

Schottverschraubungen

Artikel Nr.	Typen Nr.	für Schlauch mm	Gewinde	Ch mm	Ch1 mm	L mm	D mm	B mm
110524	12.500-5	5/3	M7x0,75	9	8	40,0	2,0	8,5
110525	12.500-6	6/4	M10x1,0	14	12	47,0	3,0	11,0
110526	12.500-8	8/6	M12x1,0	16	14	48,0	5,0	12,0
110527	12.500-10	10/8	M14x1,0	17	16	49,0	6,8	9,0
110528	12.500-12	12/10	M16x1,0	19	19	53,0	8,5	9,0

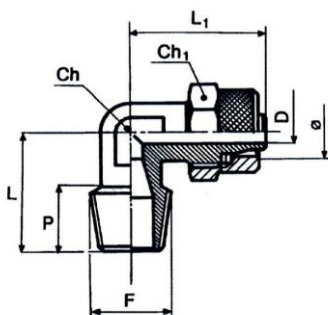

13.114-8

Winkel-Einschraubverschraubungen, Außengewinde konisch, Gewinde nach ISO 7-1

Artikel Nr.	Typen Nr.	für Schlauch mm	Gewinde F	Ch mm	Ch1 mm	P mm	L mm	L1 mm	D mm
110529	13.118-4	4/2	R 1/8	9	10	8,0	16,0	24,5	1,3
110530	13.118-5	5/3	R 1/8	8	8	8,0	17,0	21,5	2,0
110531	13.118-6	6/4	R 1/8	9	12	8,0	17,0	22,0	3,0
110532	13.118-8	8/6	R 1/8	12	14	8,0	17,0	22,0	5,0
110533	13.118-10	10/8	R 1/8	11	16	8,0	18,5	25,5	6,8
110534	13.114-6	6/4	R 1/4	9	12	11,0	20,0	22,0	3,0
110535	13.114-8	8/6	R 1/4	12	14	11,0	20,0	22,0	5,0
110536	13.114-10	10/8	R 1/4	12	16	11,0	21,0	25,0	6,8
110537	13.138-6	6/4	R 3/8	11	12	11,5	22,5	23,5	3,0
110538	13.138-8	8/6	R 3/8	12	14	12,0	21,5	23,0	5,0
110539	13.138-10	10/8	R 3/8	12	16	12,0	21,5	25,0	6,8
110540	13.138-12	12/10	R 3/8	14	19	11,5	24,0	31,0	8,5
110541	13.112-8	8/6	R 1/2	16	12	14,0	28,0	23,5	-
110542	13.112-10	10/8	R 1/2	17	16	14,0	26,0	28,5	6,8
110543	13.112-12	12/10	R 1/2	17	19	14,0	26,0	31,0	8,5

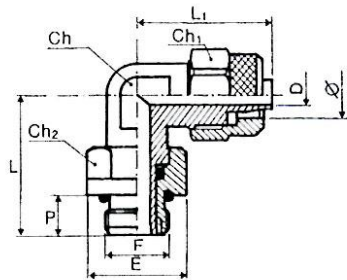

13.514-8

Winkel-Einschraubverschraubungen, drehbar, Außengewinde zylindrisch mit O-Ring (NBR)
(M5 – nicht drehbar, ohne O-Ring)

Artikel Nr.	Typen Nr.	für Schlauch mm	Gewinde F	Ch mm	Ch1 mm	Ch2 mm	P mm	E mm	L mm	L1 mm	D mm
110544	13.505-5	5/3	M5	8	8	-	4,0	-	15,0	21,5	2,0
110545	13.518-6	6/4	G 1/8	10	12	13	6,0	15,0	21,0	20,5	3,0
110546	13.518-8	8/6	G 1/8	10	14	13	6,0	15,0	21,0	21,0	5,0
110547	13.514-6	6/4	G 1/4	10	12	16	8,0	18,0	22,5	21,5	3,0
110548	13.514-8	8/6	G 1/4	12	14	16	8,0	18,0	24,0	22,0	5,0
110549	13.514-10	10/8	G 1/4	12	16	16	8,0	18,0	24,0	24,0	6,8

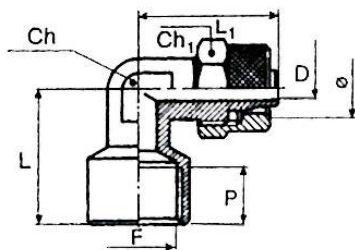

13.714-8

Winkel-Aufschraubverschraubungen

Artikel Nr.	Typen Nr.	für Schlauch mm	Gewinde F	Ch mm	Ch1 mm	P mm	L mm	L1 mm	D mm
110550	13.718-5	5/3	G 1/8	10	8	8,0	19,0	21,5	2,0
110551	13.718-6	6/4	G 1/8	10	12	8,0	19,0	22,5	3,0
110552	13.718-8	8/6	G 1/8	10	14	8,0	19,0	22,5	5,0
110553	13.714-6	6/4	G 1/4	11	12	10,5	23,0	25,0	3,0
110554	13.714-8	8/6	G 1/4	11	14	10,5	23,0	25,0	5,0
110555	13.714-10	10/8	G 1/4	13	16	11,0	23,5	26,0	6,5
110556	13.738-12	12/10	G 3/8	17	18	11,5	28,0	30,5	8,5

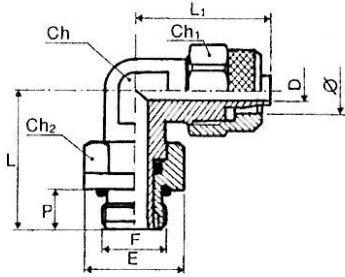

13.514-8-V

Winkel-Einschraubverschraubungen, drehbar, Außengewinde zylindrisch, mit O-Ring (FKM)

Artikel Nr.	Typen Nr.	für Schlauch mm	Gewinde F	Ch mm	Ch1 mm	CH2 mm	P mm	E mm	L mm	L1 mm	D mm
110557	13.518-6-V	6/4	G 1/8	10	12	13	6,0	15,0	21,0	20,5	3,0
110558	13.518-8-V	8/6	G 1/8	10	14	13	6,0	15,0	21,0	21,0	5,0
110559	13.514-6-V	6/4	G 1/4	10	12	16	8,0	18,0	22,5	21,5	3,0
110560	13.514-8-V	8/6	G 1/4	12	14	16	8,0	18,0	24,0	22,0	5,0
110561	13.514-10-V	10/8	G 1/4	12	16	16	8,0	18,0	24,0	24,0	6,8

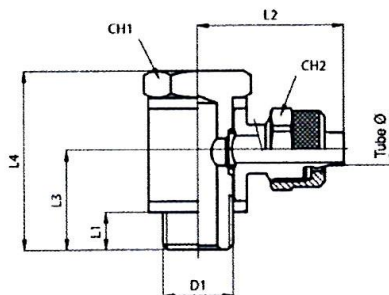

13.614-8

Winkel-Schwenkverschraubungen, Außengewinde zylindrisch mit O-Ring (NBR)

Artikel Nr.	Typen Nr.	für Schlauch mm	Gewinde D1	L1 mm	L2 mm	L3 mm	L4 mm	Ch1 mm	Ch2 mm
110562	13.605-5	5/3	M5	4,0	16,0	10,0	17,5	8	9
110563	13.605-6	6/4	M5	4,0	16,0	10,0	17,5	8	9
110564	13.618-5	5/3	G 1/8	5,5	24,0	15,0	28,0	14	9
110565	13.618-6	6/4	G 1/8	5,5	24,0	15,0	28,0	14	12
110566	13.618-8	8/6	G 1/8	5,5	24,0	15,0	28,0	14	14
110567	13.618-10	10/8	G 1/8	6,0	24,0	-	28,0	14	14
110568	13.614-6	6/4	G 1/4	6,5	26,0	17,5	33,0	17	12
110569	13.614-8	8/6	G 1/4	6,5	26,0	17,5	33,0	17	14
110570	13.614-10	10/8	G 1/4	6,5	27,5	17,5	33,0	17	16
110571	13.638-6	6/4	G 3/8	9,0	26,0	-	36,0	19	10
110572	13.638-8	8/6	G 3/8	8,5	28,5	20,0	37,0	20	14
110573	13.638-10	10/8	G 3/8	8,5	29,0	20,0	37,0	20	16
110574	13.638-12	12/10	G 3/8	9,0	31,5	22,5	36,0	5	19
110575	13.612-8	8/6	G 1/2	10,0	29,0	-	42,0	24	12
110576	13.612-10	10/8	G 1/2	9,5	30,5	23,5	42,0	27	16
110577	13.612-12	12/10	G 1/2	11,0	33,0	26,5	42,0	8	19

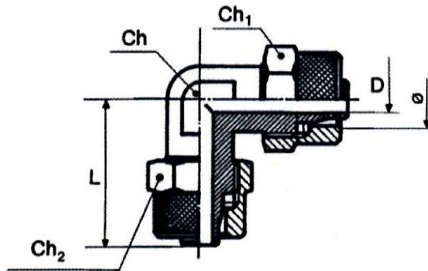

13.800-8

Winkelverbinder

Artikel Nr.	Typen Nr.	für Schlauch mm	für Schlauch 1 mm	Ch mm	Ch1 mm	L mm	D mm	Ch2 mm
110578	13.800-4	4/2	4/2	9	10	24,5	1,3	10
110579	13.800-5	5/3	5/3	8	8	21,5	2,0	8
110580	13.800-6	6/4	6/4	9	12	22,0	3,0	12
110581	13.800-8	8/6	8/6	12	14	22,0	5,0	14
110582	13.800-10	10/8	10/8	12	16	25,0	6,8	16
110583	13.800-12	12/10	12/10	14	19	30,0	8,5	19

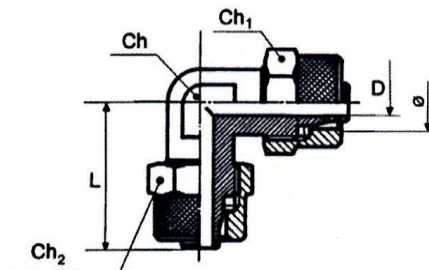

13.800-86

Winkelverbinder, reduzierend

Artikel Nr.	Typen Nr.	für Schlauch mm	für Schlauch 1 mm	Ch mm	Ch1 mm	L mm	D mm	Ch2 mm
110584	13.800-86	8/6	6/4	10	14	22,5	5,0	12

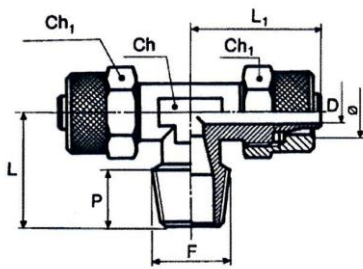

14.114-8

T-Einschraubverschraubungen, Außengewinde konisch, Gewinde nach ISO 7-1

Artikel Nr.	Typen Nr.	für Schlauch mm	Gewinde F	Ch mm	Ch1 mm	P mm	L mm	L1 mm	D mm
110585	14.118-4	4/2	R 1/8	9	10	8,0	16,0	24,5	1,3
110586	14.118-5	5/3	R 1/8	8	8	8,0	17,0	21,5	2,0
110587	14.118-6	6/4	R 1/8	8	12	8,0	17,0	22,0	3,0
110588	14.118-8	8/6	R 1/8	10	14	8,0	17,0	22,0	5,0
110589	14.118-10	10/8	R 1/8	11	16	8,0	18,5	25,5	6,8
110590	14.114-6	6/4	R 1/4	10	12	11,0	20,0	22,0	3,0
110591	14.114-8	8/6	R 1/4	10	14	11,0	20,0	22,0	5,0
110592	14.114-10	10/8	R 1/4	11	16	11,0	21,0	25,0	6,8
110593	14.138-8	8/6	R 3/8	11	14	12,0	22,0	23,0	5,0
110594	14.138-10	10/8	R 3/8	11	16	12,0	22,0	25,0	6,8
110595	14.138-12	12/10	R 3/8	14	18	12,0	24,0	31,0	8,5
110596	14.112-10	10/8	R 1/2	17	16	14,0	28,0	28,5	6,8
110597	14.112-12	12/10	R 1/2	17	18	14,0	26,0	31,0	8,5

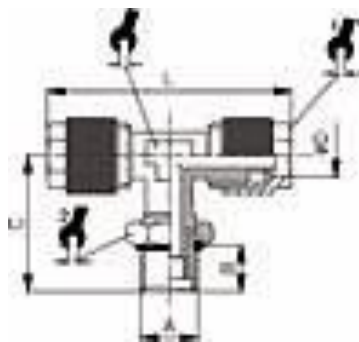

14.514-8

**T-Einschraubverschraubungen, drehbar, Außengewinde zylindrisch, mit O-Ring (NBR)
(M5 – nicht drehbar, ohne O-Ring)**

Artikel Nr.	Typen Nr.	für Schlauch mm	Gewinde	B mm	C mm	L mm	Ch mm	Ch1 mm	Ch2 mm
110598	14.505-5	5/3	M5	4,0	15,0	43,0	8	8	-
110599	14.518-6	6/4	G 1/8	6,0	22,0	39,0	8	10	13
110600	14.518-8	8/6	G 1/8	6,0	20,0	45,0	10	14	14
110601	14.514-6	6/4	G 1/4	8,0	26,0	39,0	8	10	16
110602	14.514-8	8/6	G 1/4	8,0	27,5	40,0	9	12	16
110603	14.514-10	10/8	G 1/4	8,0	27,5	45,0	11	14	16

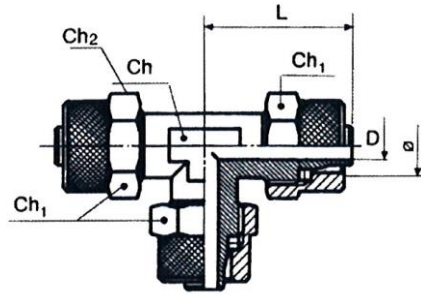

14.800-8

T-Verbinder

Artikel Nr.	Typen Nr.	für Schlauch mm	für Schlauch 1 mm	Ch mm	Ch1 mm	L mm	Ch2 mm	D mm
110604	14.800-4	4/2	4/2	9	10	24,5	10	1,3
110605	14.800-5	5/3	5/3	8	8	21,5	8	2,0
110606	14.800-6	6/4	6/4	9	12	22,0	12	3,0
110607	14.800-8	8/6	8/6	10	14	22,0	14	5,0
110608	14.800-10	10/8	10/8	12	16	25,0	16	6,8
110609	14.800-12	12/10	12/10	17	19	31,0	19	8,5

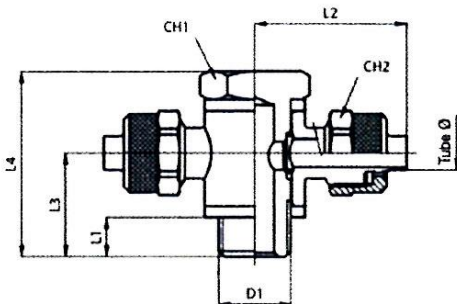

14.214-8

T-Schwenkverschraubungen, Außengewinde zylindrisch mit O-Ring (NBR)

Artikel Nr.	Typen Nr.	für Schlauch mm	Gewinde D1	L1 mm	L2 mm	L3 mm	L4 mm	Ch1 mm	Ch2 mm
110610	14.205-5	5/3	M5	4,0	16,5	-	17,5	8	8
110611	14.205-6	6/4	M5	4,0	16,5	-	17,5	8	9
110612	14.218-5	5/3	G 1/8	4,0	23,0	-	28,0	14	8
110613	14.218-6	6/4	G 1/8	5,5	24,5	15,0	28,0	14	12
110614	14.218-8	8/6	G 1/8	5,5	25,0	15,0	28,0	14	14
110615	14.218-10	10/8	G 1/8	6,0	26,5	-	28,0	14	14
110616	14.214-6	6/4	G 1/4	6,5	26,5	17,5	33,0	17	12
110617	14.214-8	8/6	G 1/4	6,5	26,0	17,5	33,0	17	14
110618	14.214-10	10/8	G 1/4	6,5	27,5	17,5	33,0	17	16
110619	14.238-6	6/4	G 3/8	9,5	26,5	-	36,0	19	10
110620	14.238-8	8/6	G 3/8	8,5	28,5	20,0	37,0	20	14
110621	14.238-10	10/8	G 3/8	8,5	29,0	20,0	37,0	20	16
110622	14.238-12	12/10	G 3/8	9,0	32,0	19,0	37,0	20	19
110623	14.212-10	10/8	G 1/2	9,5	30,5	23,5	42,0	27	16
110624	14.212-12	12/10	G 1/2	9,5	32,0	22,0	42,0	27	19

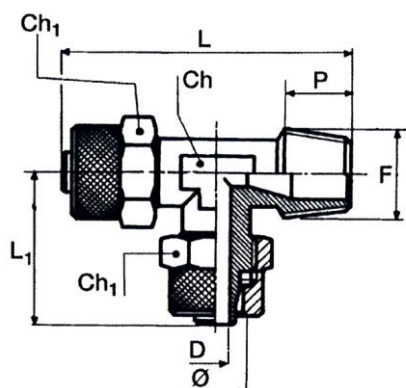

15.114-8

L-Einschraubverschraubung, Außengewinde konisch, Gewinde nach ISO 7-1

Artikel Nr.	Typen Nr.	für Schlauch mm	Gewinde F	Ch mm	Ch1 mm	P mm	L mm	L1 mm	D mm
110625	15.118-5	5/3	R 1/8	8	8	8,0	38,5	21,5	2,0
110626	15.118-6	6/4	R 1/8	9	12	8,0	39,0	22,0	3,0
110627	15.118-8	8/6	R 1/8	12	14	8,0	39,0	22,0	5,0
110628	15.114-6	6/4	R 1/4	9	12	11,0	42,0	22,0	3,0
110629	15.114-8	8/6	R 1/4	12	14	11,0	42,0	22,0	5,0
110630	15.114-10	10/8	R 1/4	11	14	12,0	41,0	25,5	-
110631	15.138-8	8/6	R 3/8	11	14	11,5	46,5	23,5	5,0
110632	15.138-10	10/8	R 3/8	12	16	12,5	47,0	25,0	6,8
110633	15.138-12	12/10	R 3/8	17	19	11,5	55,0	31,0	8,5
110634	15.112-10	10/8	R 1/2	17	16	13,5	54,5	28,5	6,8
110635	15.112-12	12/10	R 1/2	17	19	13,5	57,0	31,0	8,5

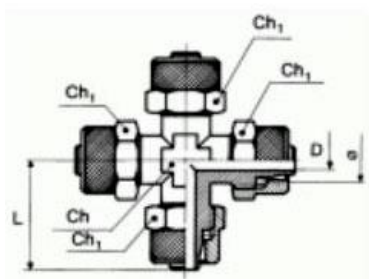

17.800-8

Kreuzverbindungen

Artikel Nr.	Typen Nr.	für Schlauch mm	Ch mm	Ch1 mm	L mm	D mm
110636	17.800-5	5/3	8	8	21,5	2,0
110637	17.800-6	6/4	8	12	22,5	3,0
110638	17.800-8	8/6	10	14	22,5	5,0
110639	17.800-10	10/8	12	16	25,5	6,8

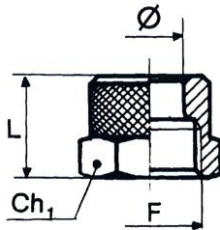

16.012-8

Überwurfmuttern

Artikel Nr.	Typen Nr.	für Schlauch mm	Gewinde F	Ch1 mm	L mm
110640	16.008-4	4/2	M8x1,0	10	11,0
110641	16.007-5	5/3	M7x0,75	8	8,5
110642	16.008-6	6/4	M8x0,5	9	9,0
110643	16.008-6.926	6/4	M8x0,75	8	11,0
110644	16.010-6	6/4	M10x1,0	12	11,0
110645	16.012-8	8/6	M12x1,0	14	11,0
110646	16.014-10	10/8	M14x1,0	16	12,0
110647	16.016-12	12/10	M16x1,0	19	12,0

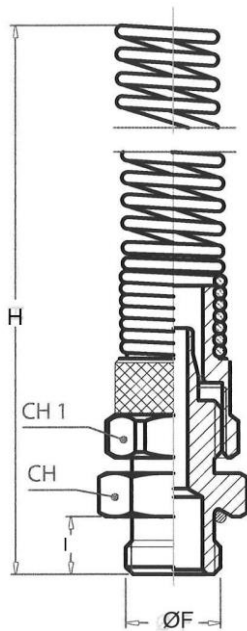

17.138-8

Gerade Einschraubverschraubung, Außengewinde zylindrisch mit O-Ring (NBR), mit Knickschutzfeder

Artikel Nr.	Typen Nr.	Gewinde	für Schlauch mm	l mm	H mm	Ch mm	Ch1 mm
110648	17.118-6	G 1/8	6/4	~ 6,0	~ 110,0	13	12
110649	17.118-8	G 1/8	8/6	~ 6,0	~ 111,0	14	14
110650	17.114-6	G 1/4	6/4	~ 8,0	~ 111,0	16	12
110651	17.114-8	G 1/4	8/6	~ 8,0	~ 111,0	16	14
110652	17.114-10	G 1/4	10/8	~ 8,0	~ 117,0	16	16
110653	17.138-8	G 3/8	8/6	~ 9,0	~ 112,0	19	14
110654	17.138-10	G 3/8	10/8	~ 9,0	~ 118,0	19	19
110655	17.138-12	G 3/8	12/10	~ 9,0	~ 129,0	19	19
110656	17.112-8	G 1/2	8/6	~ 10,0	~ 113,0	24	14
110657	17.112-10	G 1/2	10/8	~ 10,0	~ 119,0	24	16

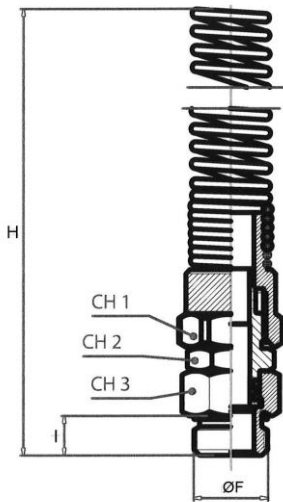

18.114-6

Gerade Einschraubverschraubungen, Außengewinde zylindrisch mit O-Ring (NBR), mit Knickschutzfeder, drehbar

Artikel Nr.	Typen Nr.	Gewinde	für Schlauch mm	I mm	H mm	Ch mm	Ch1 mm	Ch3 mm
110658	18.118-6	G 1/8	6/4	~ 6,0	~ 106,0	12	12	13
110659	18.118-8	G 1/8	8/6	~ 6,0	~ 106,0	14	12	13
110660	18.114-6	G 1/4	6/4	~ 8,0	~ 108,0	12	14	16
110661	18.114-8	G 1/4	8/6	~ 8,0	~ 108,0	14	14	16
110662	18.114-10	G 1/4	10/8	~ 8,0	~ 112,0	16	14	16
110663	18.138-12	G 3/8	12/10	~ 9,0	~ 123,0	18	17	19

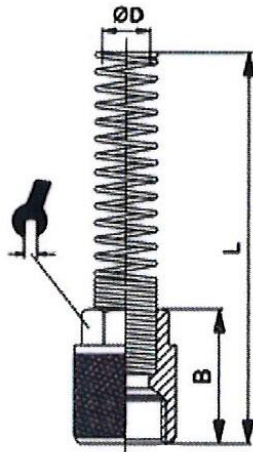

19.0806

Überwurfmutter mit Knickschutzfeder

Artikel Nr.	Typen Nr.	für Schlauch mm	Gewinde	B mm	L mm	SW mm
110664	19.0604	6/4	M10x1	~ 18,0	~ 95,0	12
110665	19.0806	8/6	M12x1	~ 18,0	~ 93,5	14
110666	19.1008	10/8	M14x1	~ 20,0	~ 96,5	16
110667	19.1210	12/10	M16x1	~ 22,0	~ 106,0	18