

MDT0350D3IH-RGB	320 x 240	RGB Interface	TFT Module
Specification			
Version: 2		Date: 02/07/2021	
Revision			
1	20/07/2019	First issue	
2	02/07/2021	Pin table update	

Display Features			
Display Size	3.5"		
Resolution	320 x 240		
Orientation	Landscape		
Appearance	RGB		
Logic Voltage	3.3V		
Interface	RGB		
Brightness	500 cd/m ²		
Touchscreen	---		
Module Size	76.90 x 63.90 x 3.26 mm		
Operating Temperature	-20°C ~ +70°C		
Pinout	54 way FFC		
Pitch	0.5mm	Box Quantity	Weight / Display
		---	---

DESIGN • MANUFACTURE • SUPPLY

* - For full design functionality, please use this specification in conjunction with the ST7272A specification.(Provided Separately)

Display Accessories	
Part Number	Description

Optional Variants	
Appearances	Voltage



General Specifications

	Feature	Spec
Characteristics	Size	3.5 inch
	Resolution	320(horizontal)*240(Vertical)
	Interface	24bit-RGB
	Connect type	Connector
	Color Depth	16.7M
	Technology type	a-Si
	Pixel pitch (mm)	0.219*0.219
	Pixel Configuration	R.G.B.Stripe
	Display Mode	Normally Black
	Driver IC	ST7272A
	Viewing Direction	Full view
Mechanical	LCM (W x H x D) (mm)	76.90*63.90*3.26
	Active Area(mm)	70.08*52.56
	Weight (g)	TBD
	LED Numbers	6 LEDs

Note 1: Requirements on Environmental Protection: RoHs

Note 2: LCM weight tolerance: +/- 5%

DESIGN • MANUFACTURE • SUPPLY



Input/Output Terminals

No.	Symbol	Description
1-2	VBL-	Backlight LED Cathode
3-4	VBL+	Backlight LED Anode.
5	Y1(NC)	Touch panel up side (NC)
6	X1(NC)	Touch panel right side (NC)
7	NC	-
8	RESET	System reset pin - Connect to VDD (pull high) in normal operation.
9	SPENB	Chip Select - Leave pin OPEN (NC)
10	SPCK	Serial Clock - Leave pin OPEN (NC)
11	SPDA	Serial Data - Leave pin OPEN (NC)
12-19	B0~B7	Data bus
20-27	G0~G7	Data bus
28-35	R0~R7	Data bus
36	HSYNC	Line Synchronous Signal
37	VSYNC	Frame Synchronous Signal
38	DOTCLK	Dot-clock signal and oscillator source
39-40	NC	-
41-42	VDD	Power supply for logic operation
43	Y2(NC)	Touch panel bottom side (NC)
44	X2(NC)	Touch panel left side (NC)
45-47	NC	-
48	IF2 (NC)	Control the input data format (NC)
49	IF1 (NC)	Control the input data format (NC)
50	IF0 (NC)	Control the input data format (NC)
51	NC	-
52	DEN	Display enable signal
53-54	GND	System Ground

*NC = No connect / These pins are not used.

Absolute Maximum Rating

Item	Symbol	MIN	Typ	MAX	Unit	Remark
Supply Voltage	V _{DD}	-0.5	-	5.0	V	-
Operating Temperature	T _{OPR}	-20	-	70	°C	-
Storage Temperature	T _{STG}	-30	-	80	°C	



Timing characteristics

ELECTRICAL CHARACTERISTICS

Item		Symbol	MIN	TYP	MAX	Unit	Remark
Supply Voltage		V_{cc}	3.0	3.3	3.6	V	
		IOVCC	1.65	3.0	3.3		
Input Signal Voltage	Low Level	V_{IL}	GND	-	0.1x VDD	V	
	High Level	V_{IH}	0.8x VDD	-	VDD	V	
Output Signal Voltage	Low Level	V_{OL}	0	-	0.2*VDD	V	
	High Level	V_{OH}	0.8*VDD	-	VDD	V	

LED Driving Conditions

Item	Symbol	MIN	TYP	MAX	Unit	Remark
Forward Current	I_F	-	20	-	mA	
Forward Voltage	V_F	18.6	19.2	19.8	V	
Backlight Power consumption	W_{BL}	-	0.384	-	W	
LED Lifetime		-	25000	-	Hrs	

Note 1: Each LED: $I_F = 20 \text{ mA}$, $V_F = 3.2 \pm 0.2 \text{ V}$.

Note 2: Optical performance should be evaluated at $T_a = 25^\circ \text{C}$ only.

Note 3: If LED is driven by high current, high ambient temperature & humidity condition. The life Time of LED will be reduced. Operating life means brightness goes down to 50% initial brightness. Typical operating life time is estimated data.

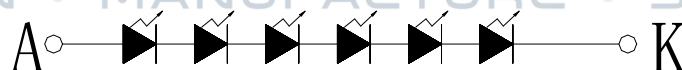

CURRENT $I_F = 20 \text{ mA}$

Figure: LED connection of backlight(Constant Current)

Block Diagram

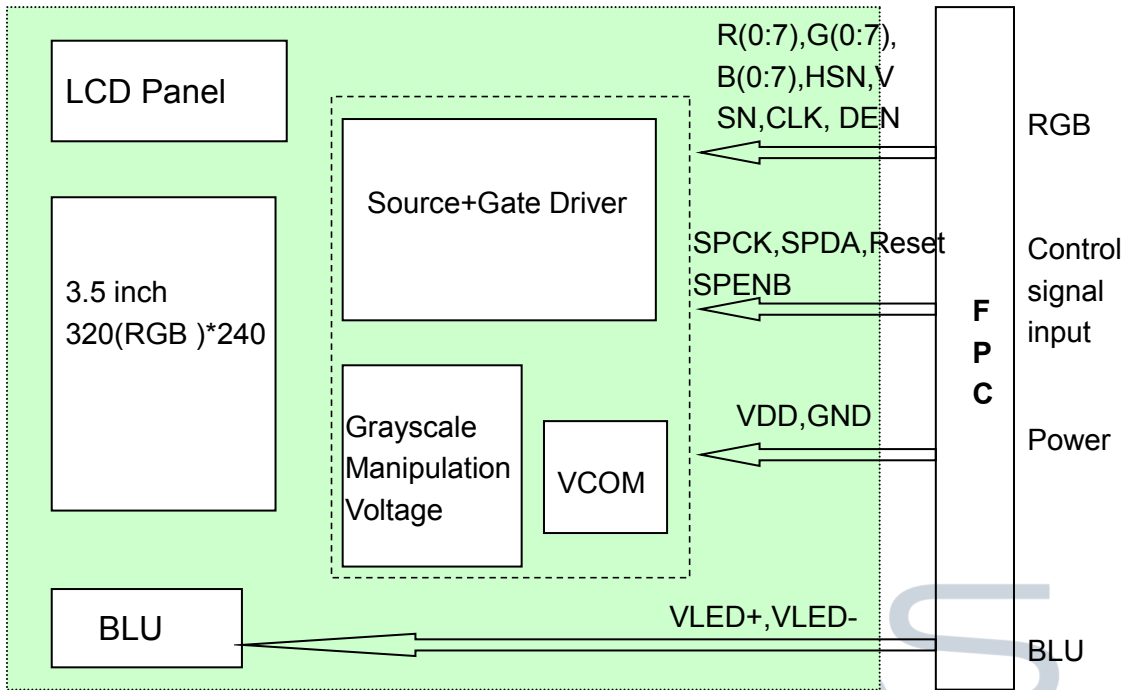

DISPLAYS

DESIGN • MANUFACTURE • SUPPLY



Interface Timing

AC Electrical Characteristics

Test Condition: (VDD=VDDP=3.3V, VDDA=5.0V, GND=GNDA=GNDA=0V, TA= 25°C)

Parameter	Symbol	Min.	Typ.	Max.	Unit	Conditions
System Operation Timing						
VDD power source slew time	T _{POB}			1000	us	From 0V to 90% VDD
RSTB active pulse width	T _{RSTB}	40			us	VDD = 3.3V
Input Output Timing						
CLKIN clock time	T _{clk}	33.3/125	-	-	ns	Please refer to timing table(p.32)
HSD to CLKIN	T _{hc}	-	-	1	CLKIN	
HSD width	T _{wh}	1	-	-	CLKIN	
VSD width	T _{vwh}	1	-	-	Th	
HSD period time	T _h	60	63.56	67	us	
VSD setup time	T _{vst}	8	-	-	ns	
VSD hold time	T _{vhd}	10	-	-	ns	
HSD setup time	T _{hst}	8	-	-	ns	
HSD hold time	T _{hhd}	10	-	-	ns	
Data set-up time	T _{dsu}	8	-	-	ns	DIN[23:0] to CLKIN
Data hold time	T _{dhd}	10	-	-	ns	DIN[23:0] to CLKIN
DEN setup time	T _{esd}	12	-	-	ns	DEN to CLKIN
Time that VSD to 1 st line data input	T _{vs}	2	13	127	Th	@CCIR601 / 8bit RGB HV mode Control by HDLY[6:0] setting T _{vs} = HDLY[6:0]
Time that CCIR_V to 1 st line data input	T _{vs}	12	20	28	Th	@CCIR656 NTSC mode Control by HDLY[6:0] setting T _{vs} = HDLY[6:0]
Time that CCIR_V to 1 st line data input	T _{vs} 17 25 33 Th					@CCIR656 PAL mode Control by HDLY[6:0] setting T _{vs} = HDLY[6:0]
Time that VSD to 1 st line data input	T _{vs}	2	13	127	Th	@24bit RGB HV mode Control by HDLY[6:0] setting T _{vs} = HDLY[6:0]
Source output stable time 1	T _{st}	-	25	30	us	96% final, CL=30pF, RL=2K
Gate output stable time	T _{gst}	-	500	1000	ns	96% final, CL=40pF
VCOMOUT output stable time	T _{cst}	-	4	8	us	96% final, CL=33nF, RL=100ohm
3-wire serial communication AC timing						
Serial clock	T _{spck}	320	-	-	ns	
SPCK pulse duty		40	50	60	%	T _{ckh} / T _{spck}
Serial data setup time	T _{isu}	120	-	-	ns	
Serial data hold time	T _{ihd}	120	-	-	ns	
Serial clock high/low	T _{ckh/l}	120	-	-	ns	
Chip select distinguish	T _{cd}	1	-	-	us	
SPENB to VSD	T _{cv}	1	-	-	us	
SPENB input setup time	T _{eck}	150	-	-	ns	
SPENB input hold time	T _{cke}	150	-	-	ns	



DC Electrical Characteristics

Recommended Operating Range

Item	Symbol	Min.	Typ.	Max.	Unit	Conditions
Supply Voltage	VDD	3.0	3.3	3.6	V	
IO Supply Voltage	VDDI	3.0	-	3.6	V	
Charge Pump Supply Voltage	PVDD	3.0	3.3	3.6	V	

DC Characteristics for Digital Circuit

Item	Symbol	Min.	Typ.	Max.	Unit	Conditions
Logic-High Input Voltage	Vih	0.7VDDI	-	VDDI	V	
Logic-Low Input Voltage	Vil	DGND	-	0.3VDDI	V	
Logic-High Output Voltage	Voh	VDDI-0.4	-	VDDI	V	
Logic-Low Output Voltage	Vol	DGND	-	DGND+0.4	V	

DC Characteristics for Analog Circuit

Item	Symbol	Min.	Typ.	Max.	Unit	Conditions
Positive High-Voltage Power	VGH	13	15	16.5	V	No Load@ FR=60Hz
Negative High-Voltage Power	VGL	-7	-10	-11	V	
Output Voltage Deviation	Vod	-	±35	±45	mV	
Standby Current	Isc	-		50	uA	
Operation Current	Ioc	-	20		mA	

24 Bit RGB Mode

Parallel 24-bit RGB Input Timing (PVDD=VDD=VDDI= 3.3V, AGND= 0V, TA=25°C)

Parallel 24-bit RGB Input Timing Table							
Item	Symbol	Min.	Typ.	Max.	Unit	Note	
DCLK Frequency	Fclk	5	6	8	MHz		
DCLK Period	Tclk	125	167	200	ns		
HSYNC	Period Time	Th	325	371	438	DCLK	
	Display Period	Thdisp		320		DCLK	
	Back Porch	Thbp	3	43	43	DCLK	SYNC mode back porch control by H_BLANKING[7:0] setting Thbp= H_BLANKING[7:0]
	Front Porch	Thfp	2	8	75	DCLK	
	Pulse Width	Thw	2	4	43	DCLK	
VSYNC	Period Time	Tv	244	260	289	HSYNC	
	Display Period	Tvdisp		240		HSYNC	
	Back Porch	Tvbp	2	12	12	HSYNC	SYNC mode back porch control by V_BLANKING[7:0] setting Tvbp= V_BLANKING[7:0]
	Front Porch	Tvfp	2	8	37	HSYNC	
	Pulse Width	Tvw	2	4	12	HSYNC	

Note: It is necessary to keep Tvbp =12 and Thbp =43 in sync mode. DE mode is unnecessary to keep it.

DESIGN • MANUFACTURE • SUPPLY



Input Data Timing

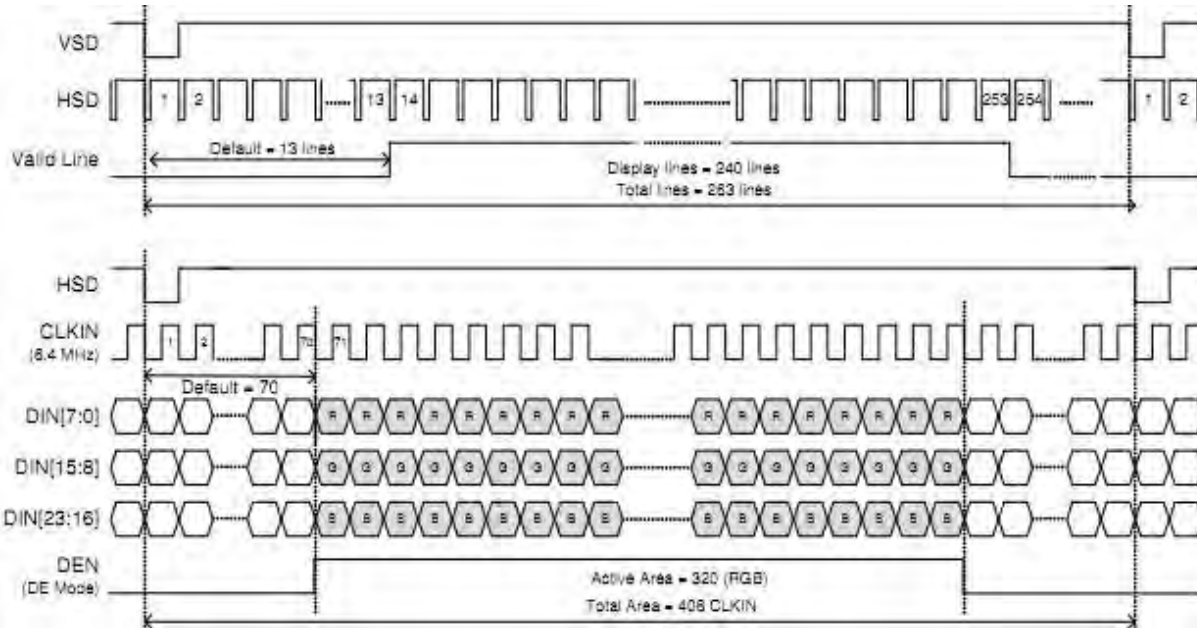

Vertical Timing Diagram (HV Mode)

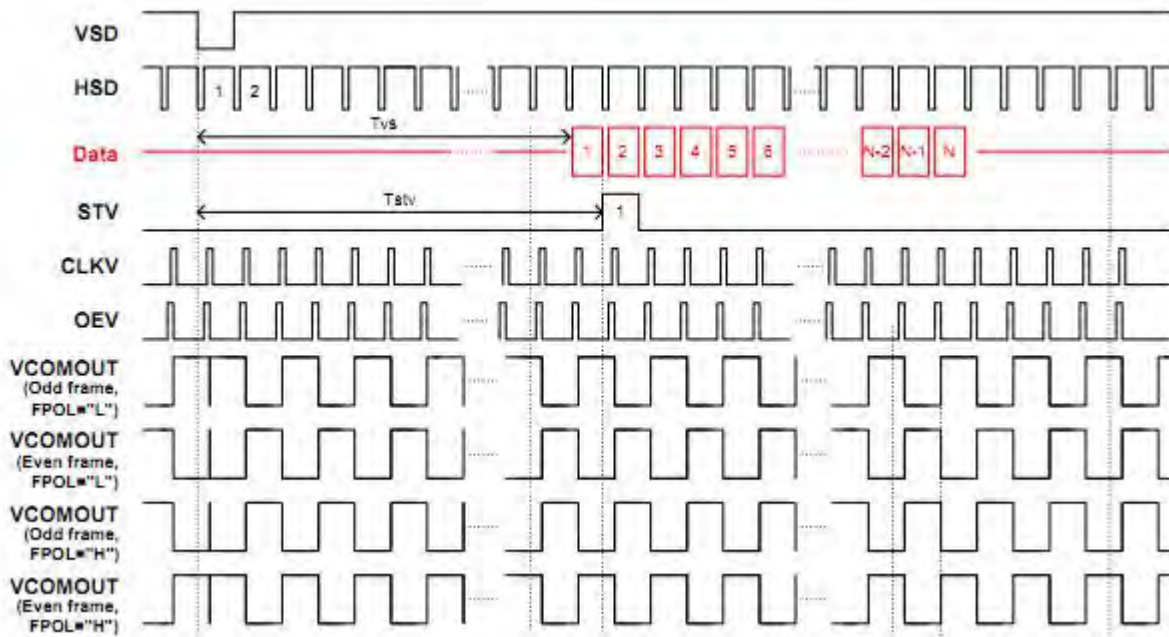

Vertical Timing Diagram (DE Mode)

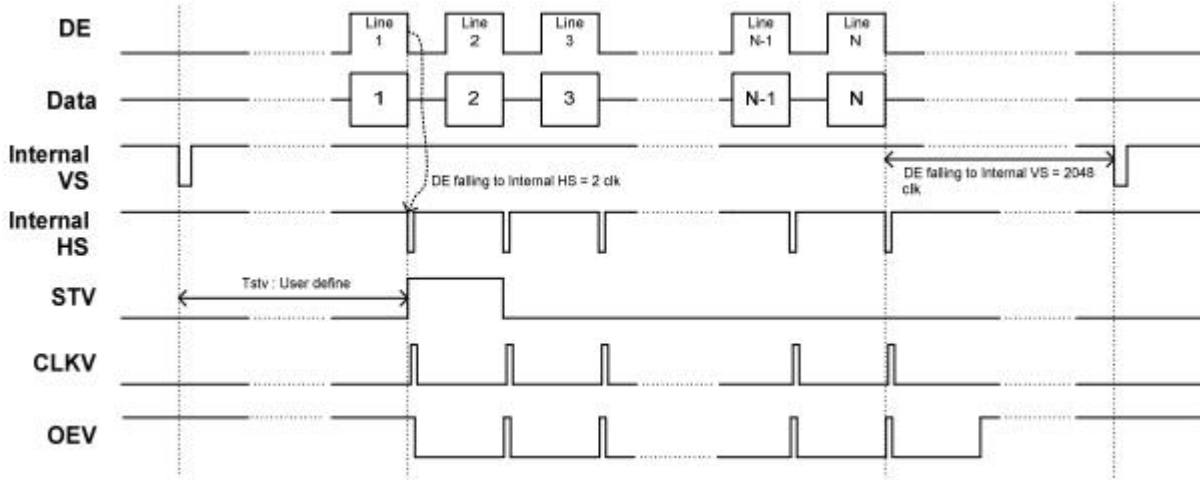

DESIGN • MANUFACTURE • SUPPLY



Optical Characteristics

Items	Symbol	Condition	Min.	Typ.	Max.	Unit	Remark	Note	
Response time	Tr+Tf	-	-	50	80	ms	FIG.1	Note4	
Contrast Ratio	CR		-	700	-	-	FIG.2	Note1	
Surface luminance	LV	$\theta = 0^\circ$	-	500	-	cd/m2	FIG.2	Note2	
Luminance uniformity	Yu	$\theta = 0^\circ$	75	80	-	%	FIG.2	Note3	
NTSC	-	$\theta = 0^\circ$	-	50	-	%	FIG.2	Note5	
Viewing angle	θ Cr>10	$\phi = 90^\circ$	-	80	-	deg	FIG.3	Note6	
		$\phi = 270^\circ$	-	80	-	deg	FIG.3		
		$\phi = 0^\circ$	-	80	-	deg	FIG.3		
		$\phi = 180^\circ$	-	80	-	deg	FIG.3		
Chromaticity	Red	R _X	$\theta = 0^\circ$ $\phi = 0^\circ$ Ta=25°	TBD	TBD	TBD	-	FIG.2 CIE1931	Note5
		R _Y		TBD	TBD	TBD	-		
	Green	G _X		TBD	TBD	TBD	-		
		G _Y		TBD	TBD	TBD	-		
	Blue	B _X		TBD	TBD	TBD	-		
		B _Y		TBD	TBD	TBD	-		
	White	W _X		TBD	TBD	TBD	-		
		W _Y		TBD	TBD	TBD	-		

Note1. Definition of contrast ratio

Contrast ratio(Cr) is defined mathematically by the following formula. For more information see FIG.2.

$$\text{Contrast ratio} = \frac{\text{Luminance with all pixels white}}{\text{Luminance with all pixels black}}$$

For contrast ratio, Surface Luminance, Luminance uniformity and CIE, the testing data is based on TOPCON's BM-5 or BM-7 photo detector or compatible.

Note2. Definition of surface luminance.

Surface luminance is the luminance with all pixels displaying white. For more information see FIG.2.

Lv = Average Surface Luminance with all white pixels(P1,P2,P3,,Pn)

Note3. Definition of luminance uniformity

The luminance uniformity in surface luminance is determined by measuring luminance at each test position 1 through n, and then dividing the maximum luminance of n points luminance by minimum luminance of n points luminance. For more information see FIG.2.



$$YU = \frac{\text{Minimum surface luminance with all white pixels (P1,P2,P3,.....,Pn)}}{\text{Maximum surface luminance with all white pixels (P1,P2,P3,.....,Pn)}}$$

Note4. Definition of response time

The response time is defined as the LCD optical switching time interval between “White” state and “Black”state. Rise time (Tr) is the time between photo detector output intensity changed from 90% to 10%. And fall time (Tf) is the time between photo detector output intensity changed from 10% to 90%.

For additional information see FIG1.

Note5. Definition of color chromaticity (CIE1931)

CIE (x,y) chromaticity, The x,y value is determined by screen active area center position P5. For more information see FIG.2.

Note6. Definition of viewing angle

Viewing angle is the angle at which the contrast ratio is greater than 10. Angles are determined for the horizontal or x axis and the vertical or y axis with respect to the z axis which is normal to the LCD surface. For more information see FIG.3.

For viewing angle and response time testing, the testing data is base on Autronic-Melchers’ s ConoScope or DMS series Instruments or compatible.



FIG.1. The definition of response Time

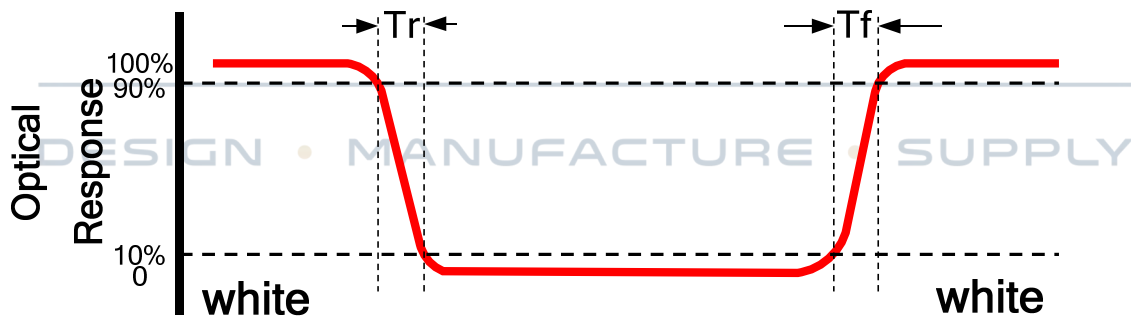

FIG.2. Measuring method for contrast ratio, surface luminance, luminance uniformity, CIE (x,y) chromaticity

Size : S≤5”(see Figure a) A : 5 mm B : 5 mm
H,V : Active area

Light spot size Ø=5mm(BM-5) or Ø=7.7mm (BM-7)50cm distance or compatible distance from the LCD surface to detector lens.

test spot position : see Figure a.

measurement instrument : TOPCON’s luminance meter BM-5 or BM-7 or compatible (see Figure c).

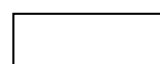
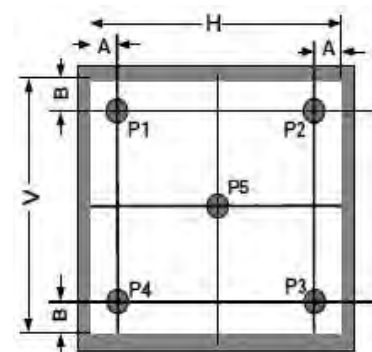

Size : $5'' < S \leq 12.3''$ (see Figure b) H,V : Active area

Light spot size $\varnothing = 5\text{mm}$ (BM-5) or $\varnothing = 7.7\text{mm}$ (BM-7) 50cm distance or compatible distance from the LCD surface to detector lens.

test spot position : see Figure b.

measurement instrument : TOPCON's luminance meter BM-5 or BM-7 or compatible (see Figure c).

Figure a

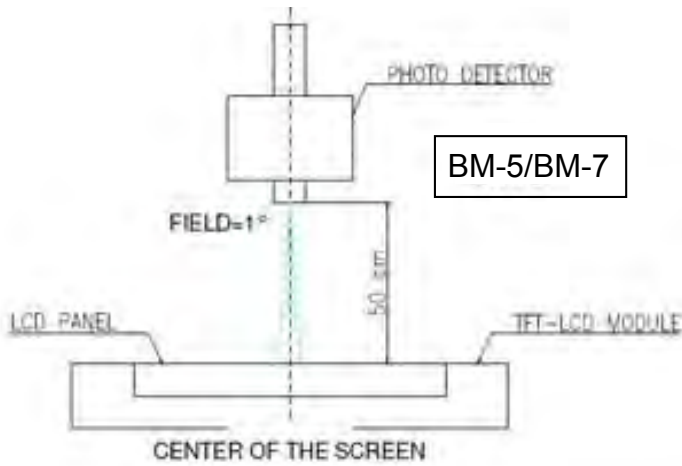
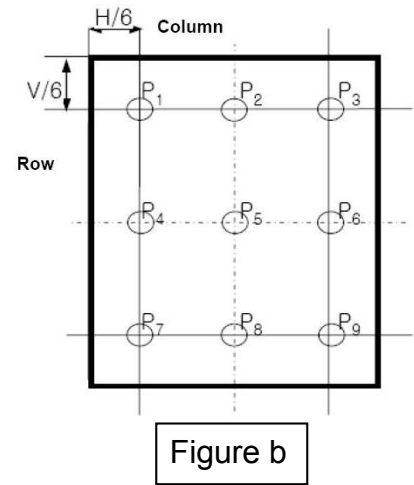
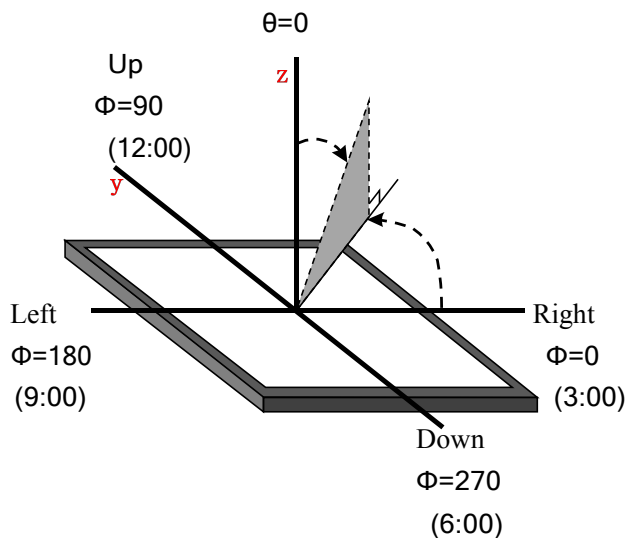

Figure c

MILAS
DISPLAYS

DESIGN • MANUFACTURE • SUPPLY

FIG.3.The definition of viewing angle



Environmental / Reliability Tests

No	Test Item	Condition	Remarks
1	High Temperature Operation	Ts= +70°C, 96hrs	Note 1 IEC60068-2-2, GB2423. 2-89
2	Low Temperature Operation	Ta= -20°C, 96hrs	Note 2 IEC60068-2-1 GB2423.1-89
3	High Temperature Storage	Ta= +80°C, 120hrs	IEC60068-2-2 GB2423. 2-89
4	Low Temperature Storage	Ta= -30°C, 120hrs	IEC60068-2-1 GB/T2423.1-89
5	High Temperature & Humidity Storage	Ta= +60°C, 90% RH max, 120 hours	IEC60068-2-3 GB/T2423.3-2006
6	Thermal Shock (Non-operation)	-20°C 30 min ~ +60°C 30 min Change time: 5min, 30 Cycle	Start with cold temperature, end with high temperature IEC60068-2-14, GB2423.22-87
7	Electro Discharge (Operation) Static	C=150pF, R=330 Ω, 5 points/panel Air:±8KV, 5 times; Contact: ±4KV, 5 times; (Environment: 15°C ~ 35°C, 30% ~ 60%, 86Kpa ~ 106Kpa)	IEC61000-4-2 GB/T17626.2-1998
8	Vibration (Non-operation)	Frequency range: 10~55Hz, Stroke: 1.mm Sweep: 10Hz~55Hz~10Hz 2 hours for each direction of X .Y. Z. (package condition)	IEC60068-2-6 GB/T2423.5-1995
9	Shock (Non-operation)	60G 6ms, ± X, ±Y , ± Z 3 times for each direction	IEC60068-2-27 GB/T2423.5-1995
10	Package Drop Test	Height: 80 cm, 1 corner, 3 edges, 6 surfaces	IEC60068-2-32 GB/T2423.8-1995

- Note:1. Ts is the temperature of panel's surface.
2. Ta is the ambient temperature of sample.
3. The size of sample is 5pcs.



TFT-LCD Module Inspection Criteria

Scope

The incoming inspection standards shall be applied to TFT - LCD Modules (hereinafter Called "Modules") that supplied by Midas Displays.

Incoming Inspection

The customer shall inspect the modules within twenty calendar days of the delivery date (the "inspection period") at its own cost. The result of the inspection (acceptance or rejection) shall be recorded in writing, and a copy of this writing will be promptly sent to The seller, If the results of the inspecting from buyer does not send to the seller within twenty Calendar days of the delivery date. The modules shall be regards as acceptance. Should the customer fail to notify the seller within the inspection period, the buyers Right to reject the modules shall be lapsed and the modules shall be deemed to have Been accepted by the buyer

Inspection Sampling

- 3.1. Lot size: Quantity per shipment lot per model
- 3.2. Sampling type: Normal inspection, Single sampling
- 3.3. Inspection level: II
- 3.4. Sampling table: MIL-STD-105E
- 3.5. Acceptable quality level (AQL)
Major defect: AQL=0.65 Minor defect: AQL=1.00

Inspection Conditions

Ambient conditions:

- a. Temperature: Room temperature $25 \pm 5^{\circ}\text{C}$
- b. Humidity: $(60 \pm 10) \% \text{RH}$
- c. Illumination: Single fluorescent lamp non-directive (300 to 700 Lux)

Viewing distance

The distance between the LCD and the inspector's eyes shall be at least 35 ± 5 cm.

Viewing Angle

U/D: $45^{\circ} / 45^{\circ}$, L/R: $45^{\circ} / 45^{\circ}$



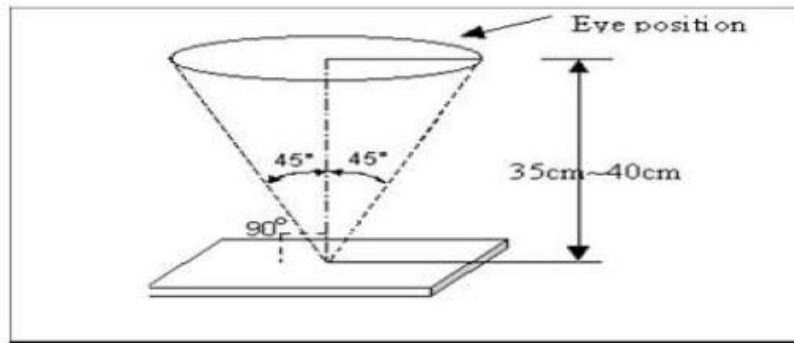

Inspection Criteria



Defects are classified as major defects and minor defects according to the degree of Defectiveness defined herein.

Major defect

Item No	Items to be inspected	Inspection Standard
5.1.1	All functional defects	1) No display 2) Display abnormally 3) Short circuit 4) line defect
5.1.2	Missing	Missing function component
5.1.3	Crack	Glass Crack

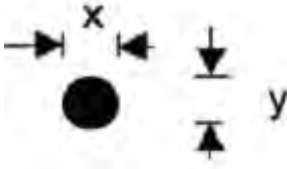
Minor defect

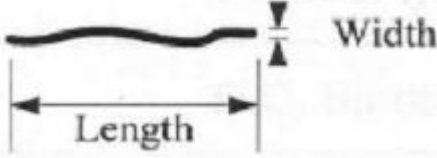
Item No	Items to be inspected	Inspection standard	
5.2.1	Spot Defect Including Black spot White spot Pinhole Foreign particle Polarizer dirt	For dark/white spot is defined $\phi = (x+y) / 2$ 	
		Size ϕ (mm)	Acceptable Quantity
		$\phi \leq 0.05$	Ignore
		$0.05 < \phi \leq 0.15$	2
		$0.15 < \phi$	Not allowed
5.2.2	Polarizer dirt,	Size ϕ (mm)	Acceptable Quantity

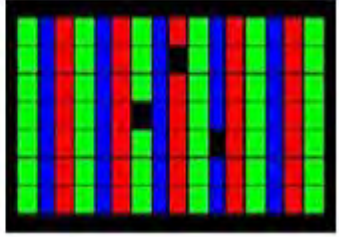
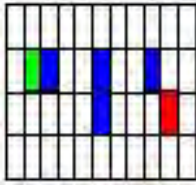
	particle	$\phi \leq 0.15$	1		
		$\Phi > 0.15$	Not allowed		
5.2.3	Line Defect Including Black line White line Scratch	Define: 			
		Width(mm) Length(mm)	Acceptable Quantity		
		$W \leq 0.05$	Ignore		
		$0.05 < W \leq 0.1$ $L \leq 1.5$	1		
		$0.1 < W$, or $L > 1.5$	Not allowed		
5.2.4	Polarizer Dent/Bubble	Not allowed			
5.2.5	Electrical Dot Defect	Bright and Black dot define:  and 			
		 Two Adjacent Dot			
		Inspection pattern: Full white, Full black, Red, green and blue screens			
		Item	Acceptable Quantity		Note
			I	O	
Black dot defect	1		(5mm ≤ Distance)		
Bright dot defect	1				
Two Adjacent Dot	Not allow				

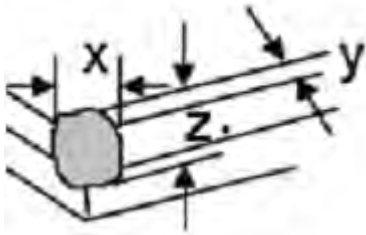
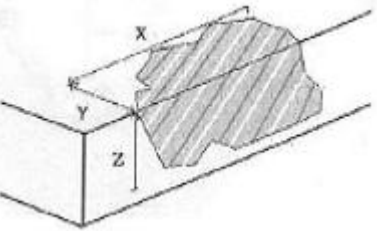

5.2.6	Glass defect	 <p>1. Corner Fragment:</p>	
		Size(mm)	Acceptable Quantity
		$X \leq 2\text{mm}$ $Y \leq 1\text{mm}$ $Z \leq T$	Ignore T: Glass thickness X: Length Y: Width Z: thickness
		<p>2. Side Fragment:</p> 	
		Size(mm)	Acceptable Quantity
		$X \leq 5.0\text{mm}$ $Y \leq 1\text{mm}$ $Z \leq T$	T: Glass thickness X: Length Y: Width Z: thickness

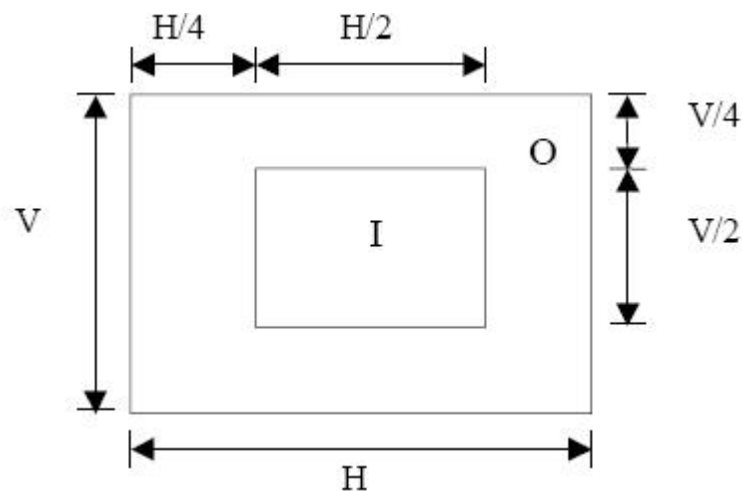

I area & O area

- Note:
- 1). Dot defect is defined as the defective area of the dot area is larger than 50% of the dot area.
 - 2). The distance between two bright dot defects (red, green, blue, and white) should be larger than 15mm.
 - 3). The distance between black dot defects or black and bright dot defects should be more than 5mm apart.
 - 4). Polarizer bubble is defined as the bubble appears on active display area. The defect of polarizer bubble shall be ignored if the polarizer bubble appears on the outside of active display area.

Mechanics specification

As for the outside dimension, weight of the modules, please refer to product specification
For more details



Precautions for Use of LCD modules

Handling Precautions

12.1.1. The display panel is made of glass. Do not subject it to a mechanical shock by dropping it from a high place, etc.

12.1.2. If the display panel is damaged and the liquid crystal substance inside it leaks out, be sure not to get any in your mouth, if the substance comes into contact with your skin or clothes, promptly wash it off using soap and water.

12.1.3. Do not apply excessive force to the display surface or the adjoining areas since this may cause the color tone to vary.

12.1.4. The polarizer covering the display surface of the LCD module is soft and easily scratched. Handle this polarizer carefully.

12.1.5. If the display surface is contaminated, breathe on the surface and gently wipe it with a soft dry cloth. If still not completely clear, moisten cloth with one of the following solvents:

- Isopropyl alcohol
- Ethyl alcohol

Solvents other than those mentioned above may damage the polarizer. Especially, do not use the following:

- Water
- Ketene
- Aromatic solvents

12.1.6. Do not attempt to disassemble the LCD Module.

12.1.7. If the logic circuit power is off, do not apply the input signals.



12.1.8. To prevent destruction of the elements by static electricity, be careful to maintain an optimum work environment.

12.1.8.1. Be sure to ground the body when handling the LCD Modules.

12.1.8.2. Tools required for assembly, such as soldering irons, must be properly ground.

12.1.8.3. To reduce the amount of static electricity generated, do not conduct assembly and other work under dry conditions.

12.1.8.4. The LCD Module is coated with a film to protect the display surface. Be care when peeling off this protective film since static electricity may be generated.

Storage Precautions

12.2.1. When storing the LCD modules, avoid exposure to direct sunlight or to the light of fluorescent lamps.

12.2.2. The LCD modules should be stored under the storage temperature range. If the LCD modules will be stored for a long time, the recommend condition is:

Temperature : 0°C ~ 40°C Relatively humidity: ≤80%

12.2.3. The LCD modules should be stored in the room without acid, alkali and harmful gas.

Transportation Precautions

The LCD modules should be no falling and violent shocking during transportation, and also should avoid excessive press, water, damp and sunshine.

MIDAS
DISPLAYS

DESIGN • MANUFACTURE • SUPPLY

