



**Part no.: 50105499**  
**BCL 504i SM 102 H**  
**Stationary bar code reader**



Figure can vary

## Contents

- Technical data
- Dimensioned drawings
- Electrical connection
- Diagrams
- Operation and display
- Part number code
- Notes
- Accessories

## Technical data

<b>Basic data</b>	
Series	BCL 500i
<b>Special design</b>	
Special design	Heating
<b>Functions</b>	
Functions	Alignment mode AutoConfig AutoControl AutoReflAct Code fragment technology Heating LED indicator Reference code comparison
<b>Characteristic parameters</b>	
MTTF	93 years
<b>Read data</b>	
Code types, readable	2/5 Interleaved Codabar Code 128 Code 39 Code 93 EAN 128 EAN 8/13 EAN Addendum GS1 Databar Expanded GS1 Databar Limited GS1 Databar Omnidirectional UPC
Scanning rate, typical	1,000 scans/s
Bar codes per reading gate, max. number	64 Piece(s)
<b>Optical data</b>	
Reading distance	300 ... 1,000 mm
Light source	Laser , Red
Laser light wavelength	650 nm
Laser class	2 , IEC/EN 60825-1:2007
Transmitted-signal shape	Continuous
Usable opening angle (reading field opening)	60 °
Bar code contrast (PCS)	60 %
Modulus size	0.35 ... 1 mm
Reading method	Line scanner
Scanning rate	800 ... 1,200 scans/s
Beam deflection	Via rotating polygon wheel
Light beam exit	Front
<b>Electrical data</b>	
Protective circuit	Polarity reversal protection
<b>Performance data</b>	
Supply voltage $U_B$	24 V , DC , -20 ... 20 %
Power consumption, max.	50 W

**Inputs/outputs selectable**

Output current, max.	100 mA
Number of inputs/outputs selectable	4 Piece(s)
Voltage type, outputs	DC
Switching voltage, outputs	Typ. $U_B / 0 V$
Voltage type, inputs	DC
Switching voltage, inputs	Typ. $U_B / 0 V$
Input current, max.	8 mA

**Interface**

Type	PROFIBUS DP
<b>PROFIBUS DP</b>	
Function	Process
Classification	V1
Transmission speed	9,600 ... 12,000,000 Mbit/s

**Service interface**

Type	USB
<b>USB</b>	
Function	Configuration via software Service

**Connection**

Number of connections	5 Piece(s)
<b>Connection 1</b>	
Type of connection	USB
Designation on device	SERVICE
Function	Service interface
Connector type	USB 2.0 Standard-A
<b>Connection 2</b>	
Type of connection	Connector
Designation on device	SW IN/OUT
Function	Signal IN Signal OUT
Thread size	M12
Type	Female
Material	Metal
No. of pins	5 -pin
Encoding	A-coded
<b>Connection 3</b>	
Type of connection	Connector
Designation on device	PWR
Function	Signal IN Signal OUT Voltage supply
Thread size	M12
Type	Male
Material	Metal
No. of pins	5 -pin
Encoding	A-coded

**Connection 4**

Type of connection	Connector
Designation on device	HOST / BUS IN
Function	BUS IN
Thread size	M12
Type	Male
Material	Metal
No. of pins	5 -pin
Encoding	B-coded

**Connection 5**

Type of connection	Connector
Designation on device	BUS OUT
Function	BUS OUT
Thread size	M12
Type	Female
No. of pins	5 -pin

**Mechanical data**

Design	Cubic
Dimension (W x H x L)	123.5 mm x 63 mm x 106.5 mm
Housing material	Metal , Aluminum
Lens cover material	Glass
Net weight	1,100 g
Housing color	Black, RAL 9005 Red, RAL 3000
Type of fastening	Dovetail grooves Mounting thread Via optional mounting device

**Operation and display**

Type of display	LED Monochromatic graphical display, 128x64 pixel, with background lighting
Number of LEDs	2 Piece(s)
Type of configuration	Via web browser
Operational controls	Button(s)

**Environmental data**

Ambient temperature, operation	-35 ... 40 °C
Ambient temperature, storage	-20 ... +70 °C
Relative humidity (non-condensing)	90 %
Extraneous light tolerance on the bar code, max.	2,000 lx

**Certifications**

Degree of protection	IP 65
Protection class	III
Certifications	c UL US
Test procedure for EMC in accordance with standard	EN 55022 EN 61000-4-2, -3, -4, -6
Test procedure for shock in accordance with standard	IEC 60068-2-27, test Ea
Test procedure for continuous shock in accordance with standard	IEC 60068-2-29, test Eb
Test procedure for vibration in accordance with standard	IEC 60068-2-6, test Fc

**Classification**

Customs tariff number	84719000
eCl@ss 8.0	27280102
eCl@ss 9.0	27280102
ETIM 5.0	EC002550
ETIM 6.0	EC002550

**Dimensioned drawings**

All dimensions in millimeters

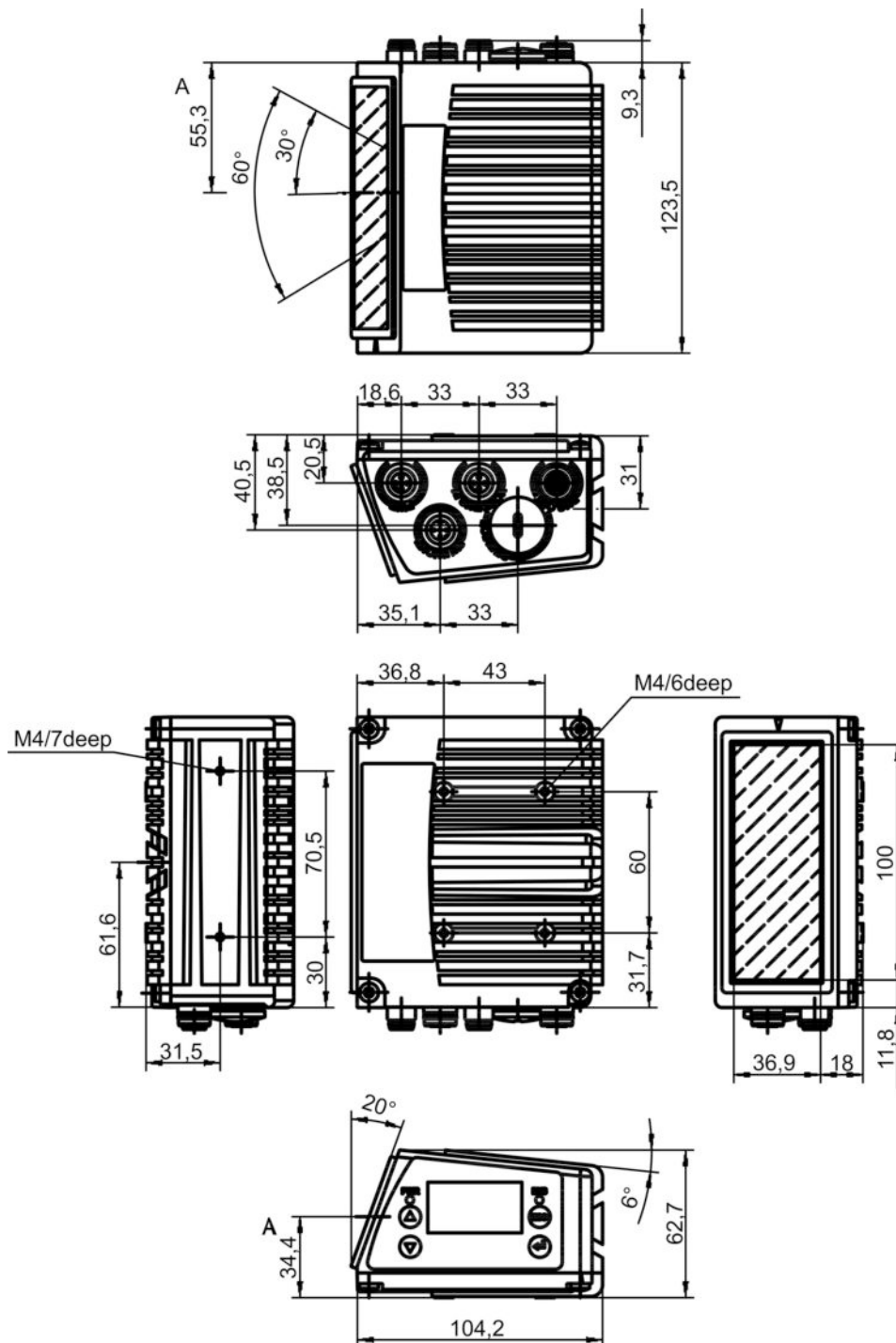

## Electrical connection

Connection 1	SERVICE
Type of connection	USB
Function	Service interface
Connector type	USB 2.0 Standard-A

Pin	Pin assignment
1	+5 V DC
2	D- - Data
3	D+ - Data
4	GND

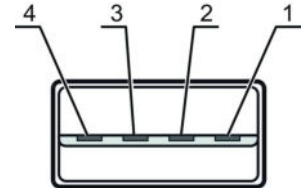

Connection 2	SW IN/OUT
Type of connection	Connector
Function	Signal IN Signal OUT
Thread size	M12
Type	Female
Material	Metal
No. of pins	5 -pin
Encoding	A-coded

Pin	Pin assignment
1	VOUT
2	SWIO 1
3	GND
4	SWIO 2
5	FE

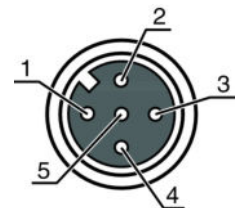

Connection 3	PWR
Type of connection	Connector
Function	Signal IN Signal OUT Voltage supply
Thread size	M12
Type	Male
Material	Metal
No. of pins	5 -pin
Encoding	A-coded

Pin	Pin assignment
1	VIN
2	SWIO 3
3	GND
4	SWIO 4
5	FE

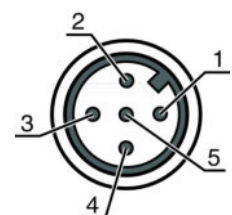

Part no.: 50105499 – BCL 504i SM 102 H – Stationary bar code reader

Connection 4	HOST / BUS IN
Type of connection	Connector
Function	BUS IN
Thread size	M12
Type	Male
Material	Metal
No. of pins	5 -pin
Encoding	B-coded

Pin	Pin assignment
1	n.c.
2	A (N)
3	n.c.
4	B (P)
5	FE

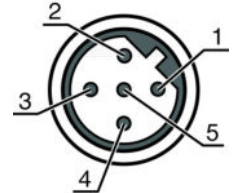

Connection 5	BUS OUT
Type of connection	Connector
Function	BUS OUT
Thread size	M12
Type	Female
Material	Metal
No. of pins	5 -pin
Encoding	B-coded

Pin	Pin assignment
1	VP
2	A (N)
3	GND 485
4	B (P)
5	FE

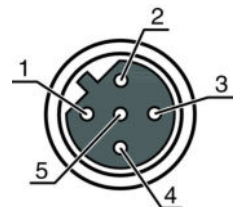

## Diagrams

### Reading field curve

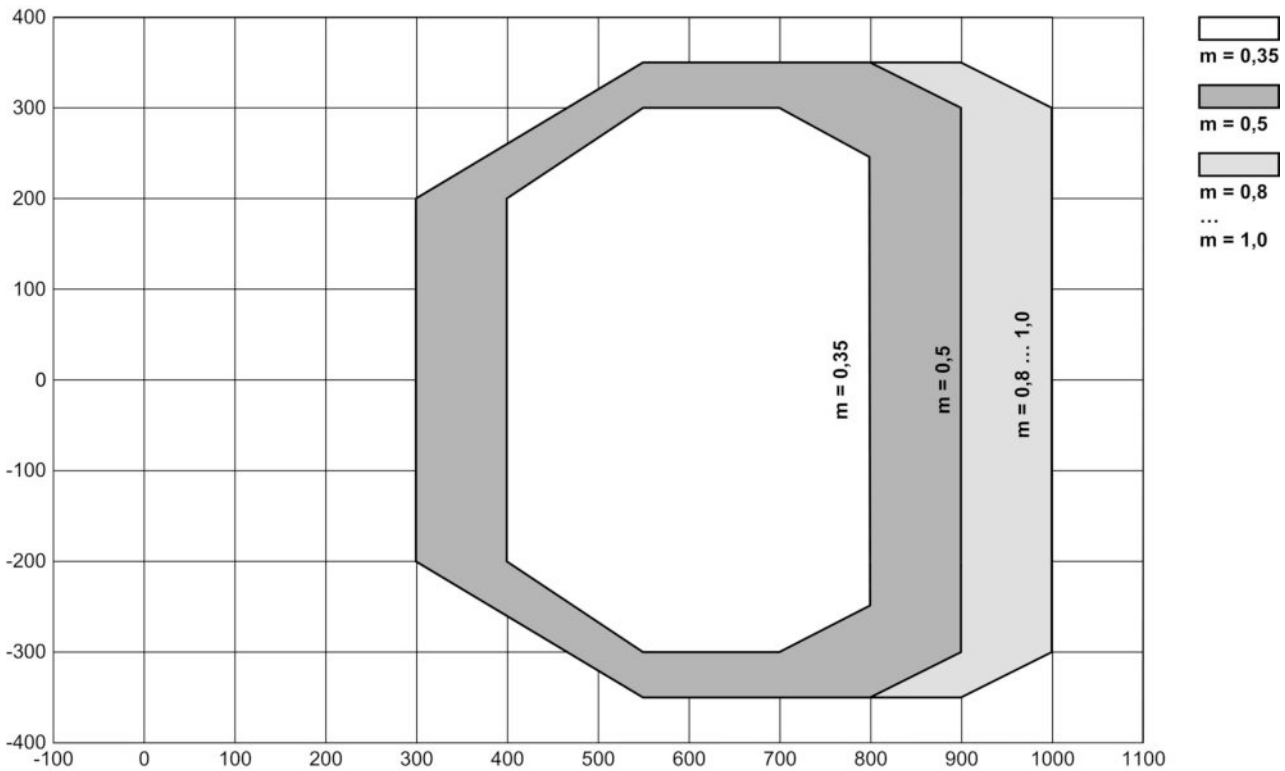

x Reading field distance [mm]  
y Reading field width [mm]

## Operation and display

### LEDs

LED	Display	Meaning	
1	PWR	Off	Device switched off
		Green, flashing	Device ok, initialization phase
		Green, continuous light	Device OK
		Orange, continuous light	Service operation
		Red, flashing	Device OK, warning set
		Red, continuous light	Device error
2	BUS	Off	No supply voltage
		Green, flashing	Initialization
		Green, continuous light	Bus operation ok
		Red, flashing	Communication error
		Red, continuous light	Network error

## Part number code

Part designation: **BCL XXXX YYZ AAA B**



## Part no.: 50105499 – BCL 504i SM 102 H – Stationary bar code reader

BCL	<b>Operating principle:</b> BCL: bar code reader
XXXX	<b>Series/interface (integrated fieldbus technology):</b> 500i: RS 232 / RS 422 / RS 485 (multiNet master) 501i: RS 485 (multiNet slave) 504i: PROFIBUS DP 508i: EtherNet TCP/IP, UDP 548i: PROFINET RT 558i: EtherNet/IP
YY	<b>Scanning principle:</b> S: line scanner (single line) O: oscillating-mirror scanner (oscillating mirror)
Z	<b>Optics:</b> N: High Density (close) M: Medium Density (medium distance) F: Low Density (remote) L: Long Range (very large distances)
AAA	<b>Beam exit:</b> 100: lateral 102: front
B	<b>Special equipment:</b> H: with heating

### Note

A list with all available device types can be found on the Leuze electronic website at [www.leuze.com](http://www.leuze.com).

## Notes

### Observe intended use!

- This product is not a safety sensor and is not intended as personnel protection.
- The product may only be put into operation by competent persons.
- Only use the product in accordance with its intended use.

### WARNING! LASER RADIATION – LASER CLASS 2

#### Never look directly into the beam!

The device satisfies the requirements of IEC 60825-1:2007 (EN 60825-1:2007) safety regulations for a product of **laser class 2** as well as the U.S. 21 CFR 1040.10 regulations with deviations corresponding to "Laser Notice No. 50" from June 24, 2007.

- Never look directly into the laser beam or in the direction of reflected laser beams! If you look into the beam path over a longer time period, there is a risk of injury to the retina.
- Do not point the laser beam of the device at persons!
- Interrupt the laser beam using a non-transparent, non-reflective object if the laser beam is accidentally directed towards a person.
- When mounting and aligning the device, avoid reflections of the laser beam off reflective surfaces!
- CAUTION! Use of controls or adjustments or performance of procedures other than specified herein may result in hazardous light exposure.
- Observe the applicable statutory and local laser protection regulations.
- The device must not be tampered with and must not be changed in any way.  
There are no user-serviceable parts inside the device.  
Repairs must only be performed by Leuze electronic GmbH + Co. KG.

**NOTE**

**Affix laser information and warning signs!**

Laser information and warning signs are affixed to the device. In addition, self-adhesive laser information and warning signs (stick-on labels) are supplied in several languages.

- Affix the laser information sheet to the device in the language appropriate for the place of use. When using the device in the US, use the stick-on label with the "Complies with 21 CFR 1040.10" note.
- Affix the laser information and warning signs near the device if no signs are attached to the device (e.g. because the device is too small) or if the attached laser information and warning signs are concealed due to the installation position.
- Affix the laser information and warning signs so that they are legible without exposing the reader to the laser radiation of the device or other optical radiation.

## Accessories

### Connection technology - Connection cables

	Part no.	Designation	Article	Description
	50132079	KD U-M12-5A-V1-050	Connection cable	Connection 1: Connector, M12, Axial, Female, A-coded, 5 -pin Connection 2: Open end Shielded: No Cable length: 5,000 mm Sheathing material: PVC

### Connection technology - Interconnection cables

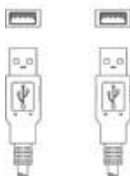
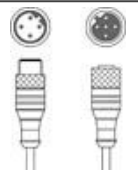
	Part no.	Designation	Article	Description
	50107726	KB USB A - USB A	Interconnection cable	Suitable for interface: USB Connection 1: USB Connection 2: USB Shielded: Yes Cable length: 1,800 mm Sheathing material: PVC
	50135254	KDS PB-M12-4A-M12-4A-P3-050	Interconnection cable	Suitable for interface: PROFIBUS DP Connection 1: Connector, M12, Axial, Female, B-coded, 2 -pin Connection 2: Connector, M12, Axial, Male, B-coded, 4 -pin Shielded: Yes Cable length: 5,000 mm Sheathing material: PUR

### Connection technology - Terminating resistors





	Part no.	Designation	Article	Description
	50038539	TS 02-4-SA	Terminator plug	Suitable for: MultiNet Plus, PROFIBUS DP Connection 1: Connector, M12, Axial, Male, B-coded, 4 -pin Function: Bus termination

Part no.: 50105499 – BCL 504i SM 102 H – Stationary bar code reader

## Mounting technology - Other

	Part no.	Designation	Article	Description
	50111224	BT 59	Mounting bracket	Fastening, at system: Groove mounting Mounting bracket, at device: Clampable Material: Metal

## Services

	Part no.	Designation	Article	Description
	S981020	CS30-E-212	Hourly rate for "Configuration"	Details: Compilation of the application data, selection and suggestion of suitable sensor system, drawing prepared as assembly sketch. Conditions: Completed questionnaire or project specifications with a description of the application have been provided. Restrictions: Travel and accommodation charged separately and according to expenditure.
	S981014	CS30-S-110	Start-up support	Details: Performed at location of customer's choosing, duration: max. 10 hours. Conditions: Devices and connection cables are already mounted, price not including travel costs and, if applicable, accommodation expenses. Restrictions: No mechanical (mounting) and electrical (wiring) work performed, no changes (attachments, wiring, programming) to third-party components in the nearby environment.
	S981019	CS30-T-110	Product training	Details: Location and content to be agreed upon, duration: max. 10 hours. Conditions: Price not including travel costs and, if applicable, accommodation expenses. Restrictions: Travel costs and accommodation expenses charged separately and according to expenditure.
	S981021	CS30-V-212	Hourly rate for "Bar code qualification"	Details: REA evaluation with creation of a test report, evaluation of the code quality. Conditions: Original bar codes to be provided by the client.

### Note

A list with all available accessories can be found on the Leuze electronic website in the Download tab of the article detailed page.