



Figure can vary

Part no.: 68000107
MLC500T14-750
Safety light curtain transmitter



Contents

- . Technical data
- . Dimensioned drawings
- . Electrical connection
- . Circuit diagrams
- . Operation and display
- . Suitable receivers
- . Part number code
- . Notes
- . Accessories

Technical data

Basic data	
Series	MLC 500
Device type	Transmitter
Contains	2x BT-NC sliding block
Application	Finger protection
Functions	
Functions	Range reduction Transmission channel changeover
Characteristic parameters	
Type	4 , IEC/EN 61496
SIL	3 , IEC 61508
SILCL	3 , IEC/EN 62061
Mission time T_M	20 years , EN ISO 13849-1
Protective field data	
Resolution	14 mm
Protective field height	750 mm
Operating range	0 ... 6 m
Optical data	
Synchronization	Optical between transmitter and receiver
Light source	LED , Infrared
LED light wavelength	940 nm
Transmitted-signal shape	Pulsed
LED group	Exempt group in acc. with EN 62471:2008
Electrical data	
Protective circuit	Overvoltage protection Short circuit protected
Performance data	
Supply voltage U_B	24 V , DC , -20 ... 20 %
Current consumption, max.	50 mA
Fuse	2 A semi time-lag
Inputs	
Number of digital switching inputs	1 Piece(s)
Switching inputs	
Type	Digital switching input
Switching voltage high, min.	18 V
Switching voltage low, max.	2.5 V
Switching voltage, typ.	22.5 V
Voltage type	DC
Connection	
Number of connections	1 Piece(s)

Part no.: 68000107 – MLC500T14-750 – Safety light curtain transmitter
Connection 1

Type of connection	Connector
Function	Machine interface
Thread size	M12
Material	Metal
No. of pins	5 -pin

Cable properties

Permissible conductor cross section, typ.	0.25 mm ²
Length of connection cable, max.	100 m
Permissible cable resistance to load, max.	200 Ω

Mechanical data

Dimension (W x H x L)	29 mm x 816 mm x 35.4 mm
Housing material	Metal , Aluminum
Lens cover material	Plastic / PMMA
Material of end caps	Diecast zinc
Net weight	900 g
Housing color	Yellow, RAL 1021
Type of fastening	Groove mounting Mounting bracket Mounting on Device Column Swivel mount

Operation and display

Type of display	LED
Number of LEDs	2 Piece(s)

Environmental data

Ambient temperature, operation	-30 ... 55 °C
Ambient temperature, storage	-30 ... 70 °C
Relative humidity (non-condensing)	0 ... 95 %

Certifications

Degree of protection	IP 65
Protection class	III
Certifications	c CSA US c TÜV NRTL US S Mark TÜV Süd
Vibration resistance	50 m/s ²
Shock resistance	100 m/s ²
US patents	US 6,418,546 B

Classification

Customs tariff number	85365019
eCl@ss 8.0	27272704
eCl@ss 9.0	27272704
ETIM 5.0	EC002549
ETIM 6.0	EC002549

Dimensioned drawings

All dimensions in millimeters

Calculation of the effective protective field height $H_{PFE} = H_{PFN} + B + C$



H_{PFE} Effective protective field height = 762 mm

H_{PFN} Nominal protective field height = 750 mm

A Total height = 816 mm

B 6 mm

C 6 mm

R Effective protective field height H_{PFE} goes beyond the dimensions of the optics area to the outer borders of the circles labeled with R.

Electrical connection

Connection 1	
Type of connection	Connector
Function	Machine interface
Thread size	M12
Type	Male
Material	Metal
No. of pins	5 -pin
Encoding	A-coded
Connector housing	FE/SHIELD

Pin	Pin assignment	Conductor color
1	VIN1	Brown
2	n.c.	White
3	VIN2	Blue
4	RNG	Black
5	FE/SHIELD	Gray



Circuit diagrams

Transmission channel C1, reduced range



- 1 VIN1 = +24 V
- 3 VIN2 = 0 V
- 4 RNG = 0 V or open

Transmission channel C1, standard range

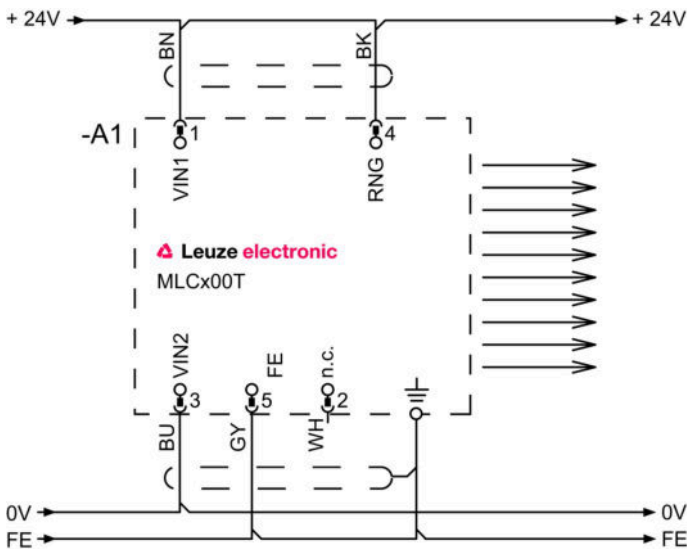

- 1 VIN1 = +24 V
- 3 VIN2 = 0 V
- 4 RNG = +24 V

Transmission channel C2, reduced range



- 1 VIN1 = 0 V
- 3 VIN2 = +24 V
- 4 RNG = 0 V or open

Transmission channel C2, standard range



- 1 VIN1 = 0 V
- 3 VIN2 = +24 V
- 4 RNG = +24 V

Operation and display



LEDs

LED	Display	Meaning
1	Off	Device switched off

Part no.: 68000107 – MLC500T14-750 – Safety light curtain transmitter

LED	Display	Meaning
	Red, continuous light	Device error
	Green, continuous light	Normal operation
2	Green, flashing, 10 s long after switching on	Reduced range selected by the wiring of pin 4
	Off	Transmission channel C1
	Green, continuous light	Transmission channel C2

Suitable receivers

	Part no.	Designation	Article	Description
	68001107	MLC510R14-750	Safety light curtain receiver	Resolution: 14 mm Protective field height: 750 mm Response time: 17 ms Connection: Connector, M12, Metal, 5 -pin Function package: Basic
	68002107	MLC520R14-750	Safety light curtain receiver	Resolution: 14 mm Protective field height: 750 mm Response time: 17 ms Connection: Connector, M12, Metal, 8 -pin Function package: Standard
	68003107	MLC530R14-750	Safety light curtain receiver	Resolution: 14 mm Protective field height: 750 mm Response time: 17 ms Connection: Connector, M12, Metal, 8 -pin Function package: Extended

Part number code

Part designation: **MLCxyy-za-hhhhei-ooo**

MLC	Safety light curtain
x	Series: 3: MLC 300 5: MLC 500
yy	Function classes: 00: transmitter 01: transmitter (AIDA) 02: transmitter with test input 10: basic receiver - automatic restart 11: basic receiver - automatic restart (AIDA) 20: standard receiver - EDM/RES selectable 30: extended receiver - blanking/muting
z	Device type: T: transmitter R: receiver
a	Resolution: 14: 14 mm 20: 20 mm 30: 30 mm 40: 40 mm 90: 90 mm
hhhh	Protective field height: 150 ... 3000: from 150 mm to 3000 mm
e	Host/Guest (optional): H: Host MG: Middle Guest G: Guest

Part no.: 68000107 – MLC500T14-750 – Safety light curtain transmitter

MLC	Safety light curtain
i	Interface (optional): /A: AS-i
000	Option: /V: high Vibration-proof EX2: explosion protection (zones 2 + 22) SPG: Smart Process Gating

Note
A list with all available device types can be found on the Leuze electronic website at www.leuze.com .

Notes

Observe intended use!
<ul style="list-style-type: none"> The product may only be put into operation by competent persons. Only use the product in accordance with its intended use.

Accessories

Connection technology - Connection cables

	Part no.	Designation	Article	Description
	50133860	KD S-M12-5A-P1-050	Connection cable	Connection 1: Connector, M12, Axial, Female, A-coded, 5 -pin Connection 2: Open end Shielded: Yes Cable length: 5,000 mm Sheathing material: PUR



Mounting technology - Swivel mounts

	Part no.	Designation	Article	Description
	429393	BT-2HF	Mounting bracket set	Contains: 2x BT-HF swivel mount, 1 cylinder for mounting on the light curtain Fastening, at system: Through-hole mounting Mounting bracket, at device: Clampable Type of mounting device: Turning, 360° Material: Metal, Plastic

Alignment aids

	Part no.	Designation	Article	Description
	520101	AC-ALM-M	Alignment aid	Housing material: Plastic

Services

	Part no.	Designation	Article	Description
	S981050	CS40-I-140	Safety inspection "Safety light barriers"	<p>Details: Checking of a safety light barrier application in accordance with current standards and guidelines. Inclusion of the device and machine data in a database, production of a test log per application.</p> <p>Conditions: It must be possible to stop the machine, support provided by customer's employees and access to the machine for Leuze employees must be ensured.</p> <p>Restrictions: Travel costs and accommodation expenses charged separately and according to expenditure.</p>
	S981046	CS40-S-140	Start-up support	<p>Details: For safety devices including stopping time measurement and initial inspection.</p> <p>Conditions: Devices and connection cables are already mounted, price not including travel costs and, if applicable, accommodation expenses.</p> <p>Restrictions: Max. 2 h., no mechanical (mounting) and electrical (wiring) work performed, no changes (attachments, wiring, programming) to third-party components in the nearby environment.</p>

Note

A list with all available accessories can be found on the Leuze electronic website in the Download tab of the article detailed page.