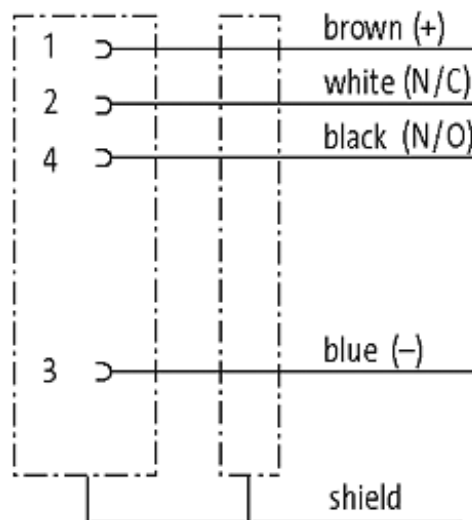

M12 FEMALE 90° SHIELDED

PUR 4X0.34 shielded GRAY, UL/CSA 10m

M12
Female 90°
4-pole, shielded

Plastic housings with good resistance against chemicals and oils. The resistance to aggressive media should be individually tested for your application. Further details on request. Further cable lengths on request.

[Link to Product](#)**Illustration**

Female

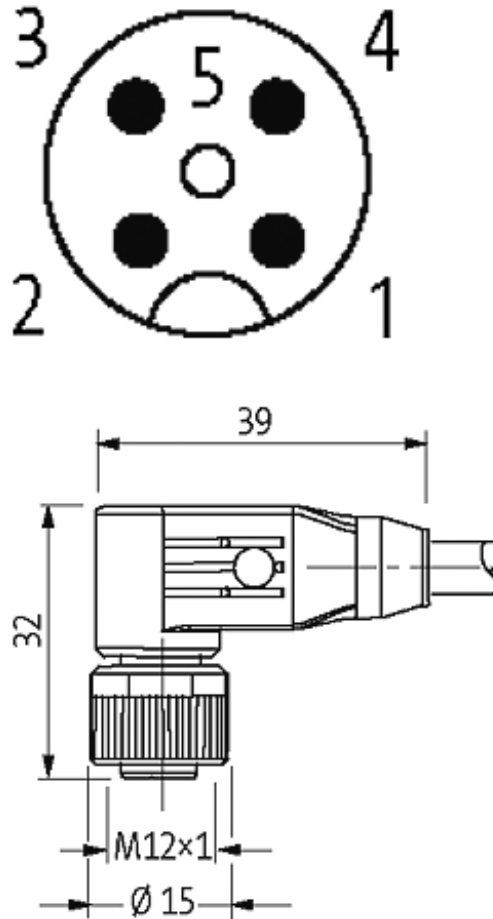

Product may differ from Image

Approvals



Form

13261

Technical Data

| | |
|-------------------------------|---|
| Operating voltage | max. 60 V AC/DC |
| Operating current per contact | max. 4 A |
| Locking of ports | Screw thread M12 × 1 mm (recommended torque 0.6 Nm) self-securing |
| Protection | IP67 inserted and tightened (EN 60529) |

Cables

| | |
|--------------|-----|
| Cable number | 335 |
|--------------|-----|

| | |
|-----------------------------|--------------------------|
| No./diameter of wires | 4 × 0.34 mm ² |
| Wire isolation | PP (br, wh, bl, bk) |
| Jacket Color | gray |
| Shore hardness outer jacket | 85 ± 3A |
| Material (jacket) | PUR (UL/CSA) |
| Outer diameter | approx. 5.9 mm |
| Bend radius (fixed) | 10 × outer Ø |
| Bend radius (moving) | 10 × outer Ø |
| Temperature range (fixed) | -40...+80 °C |
| Temperature range (mobile) | -20...+80 °C |
| Shielded | yes |

Commercial data

| | |
|------------------------|----------|
| country of origin | DE |
| customs tariff number | 85444290 |
| minimum order quantity | 1 |