

Interlock Switches  
Interlock Switches with Solenoid

# HS6B

# HS6E

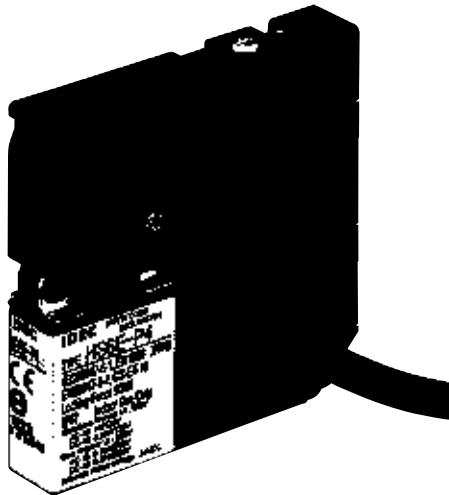



Compact with three poles of contacts.  
(HS6B)



Small interlock switch with five poles and solenoid. (HS6E)



• See website for details on approvals and standards.

	Model	Features	Page
	HS6B	Without Solenoid	E-007
	HS6E	With Solenoid	E-011

## Space saving design with angled connection cable

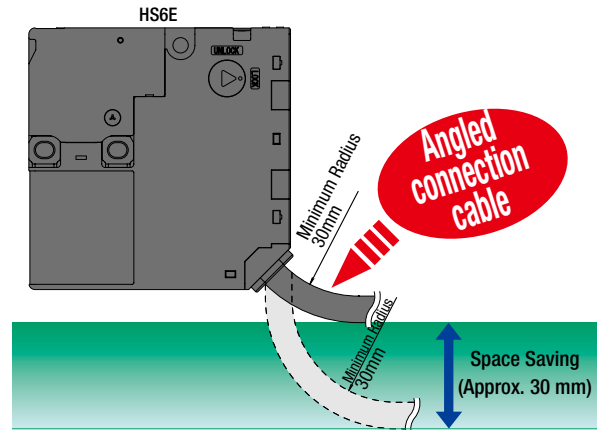

## Manual Unlocking Possible from Three Directions

The actuator can be unlocked manually with manual unlocks on either sides of the switch body (HS6E)

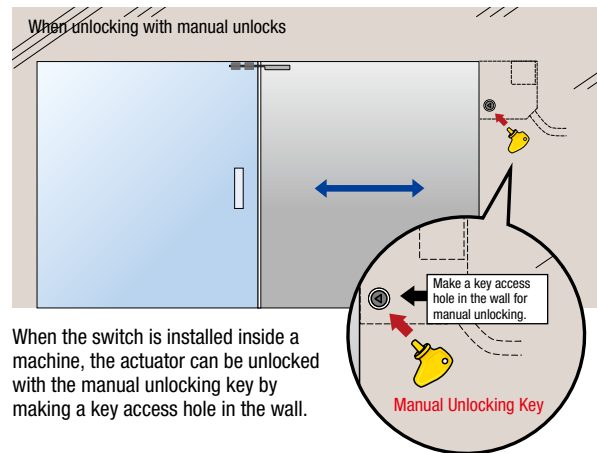

When the switch is installed inside a machine, the actuator can be unlocked with the manual unlocking key by making a key access hole in the wall.

## Optically enhanced lens provides for wide viewing angle for power indicator

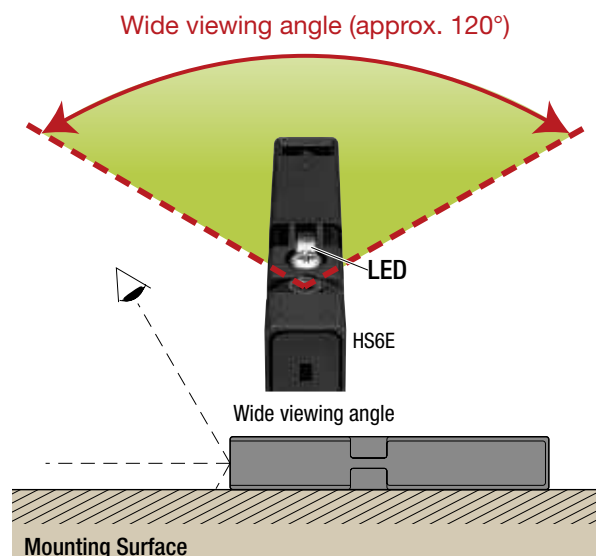

## Application Example

**Contributes to downsizing of semiconductor manufacturing equipment. Thinnest safety door switches on the market.**

### Downsizing equipment used inside clean rooms

As clean rooms cannot be easily expanded, the demand for downsizing of equipment is high to utilize limited space. However, even if downsizing is mechanically possible, the size of each part becomes a bottleneck and equipment cannot be made smaller in many cases.

For example, when using parts that comply with SEMI standards, by considering safety, it is difficult to find the appropriate size for parts and end up wasting space. Many of the semiconductor manufacturing equipment manufacturers most likely want to use small parts.



### Thinnest door lock switches in its class expands flexibility in design

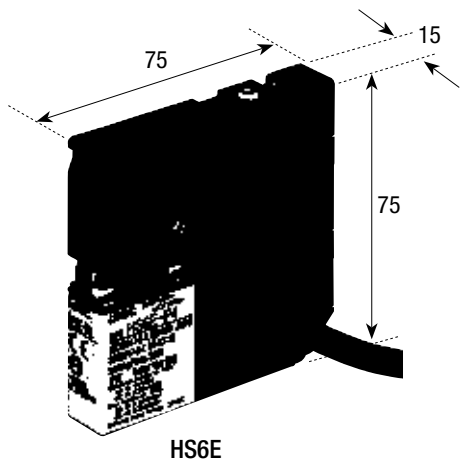

Dimensions in mm.

- APEM
- Switches & Pilot Lights
- Control Boxes
- Emergency Stop Switches
- Enabling Switches
- Safety Products
- Explosion Proof
- Terminal Blocks
- Relays & Sockets
- Circuit Protectors
- Power Supplies
- LED Illumination
- Controllers
- Operator Interfaces
- Sensors
- AUTO-ID
- Interlock Switches
- Non-contact Interlock Switches
- Safety Laser Scanners
- Safety Light Curtains
- Safety Modules

- HS6B
- HS6E
- HS5D
- HS5L
- HS1L
- Actuators for HS1/HS5/HS6
- Actuators/ Padlock Hasp

# HS6B Subminiature Interlock Switches

## Compact interlock switch with three poles of contacts.

- Compact size: 30 × 15 × 78 mm
- Dual contacts and monitor contacts achieve the highest safety category (ISO 13849-1, EN 954-1)
- Two actuator entry slots provide flexibility for installation options.
- Integral cable design minimizes wiring, preventing wiring mistakes.
- Can be mounted in two directions.
- Degree of protection (contacts): IP67 (IEC 60529)  
Housing allows drainage.
- NC contacts are direct opening action (IEC/EN 60947-5-1).
- Proprietary actuators prevent unauthorized opening of the contacts (ISO14119, EN1088).

## Interlock Switch

Contact Configuration	Cable Length	Part No. (Ordering Part No.)
1NC-1NO 	1m	HS6B-11B01
	3m	HS6B-11B03
	5m	HS6B-11B05
2NC 	1m	HS6B-02B01
	3m	HS6B-02B03
	5m	HS6B-02B05
2NC-1NO 	1m	HS6B-12B01
	3m	HS6B-12B03
	5m	HS6B-12B05
3NC 	1m	HS6B-03B01
	3m	HS6B-03B03
	5m	HS6B-03B05

- Contact configuration shows the status when the actuator is inserted.
- See **E-010** for wiring.

## Actuators

Description	Part No. (Ordering Part No.)
Straight Actuator	HS9Z-A61
Right-angle Actuator	HS9Z-A62
Horizontal/vertical Angle Adjustable Actuator (for hinged doors) (Note)	HS9Z-A65
	HS9Z-A66

Note: Select an actuator that moves in the direction required by the hinged door and interlock switch (see **E-009** and **E-010**).

- See **E-069** for details on actuators and actuator dimensions.

## Contact Ratings

Rated Insulation Voltage (Ui)		300V			
Rated Current (Ith)		2.5A			
Rated Voltage (Ue) *		30V	125V	250V	
Rated Current (Ie) *	AC	Resistive load (AC-12)	—	2.5A	1.5A
		Inductive Load (AC-15)	—	1.5A	0.75A
	DC	Resistive load (DC-12)	2.5A	1.1A	0.55A
		Inductive Load (DC-13)	2.3A	0.55A	0.27A

- Minimum applicable load (reference): 3V AC/DC, 5mA

## Approved ratings

TÜV	AC-15 240V/0.75A DC-13 250V/0.27A DC-13 30V/2.3A
UL/c-UL	240V AC/0.75A Pilot Duty 250V DC/0.27A Pilot Duty C300 Q300
CCC	AC-15 240V/0.75A DC-13 30V/2.3A

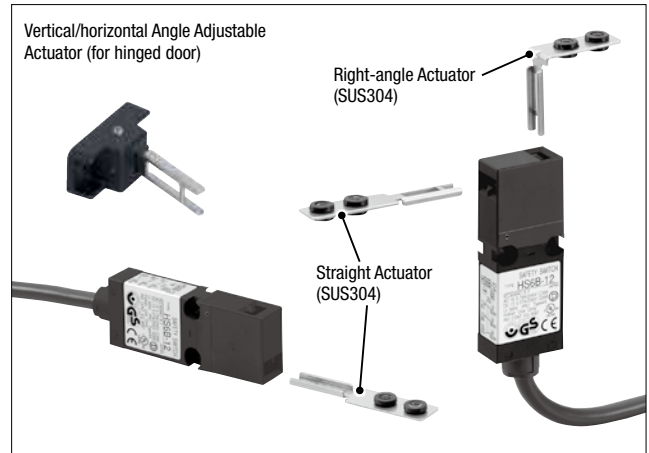

## Specifications

Applicable Standards	ISO14119 IEC60947-5-1 EN60947-5-1 (TÜV approved) GS-ET-15 (TÜV approved) UL508 (UL-listed) CSA C22.2 No. 14 (c-UL-listed) GB/T14048.5 (CCC approved) KS C IEC60947-5-1/S1-G-1/S2-E-4 (KOSHA approved)
Applicable Directive	IEC 60204-1/ EN 60204-1 (applicable standards for use)
Applicable Directive	2006/95/EC (Low Voltage Directive) 2006/42/EC (Machinery Directive)
Operating Temperature	-25 to +70°C (no freezing)
Relative Humidity	45 to 85% (no condensation)
Storage Temperature	-40 to +80°C (no freezing)
Pollution Degree	3
Impulse Withstand Voltage	4 kV
Insulation Resistance (500V DC megger)	Between live and dead metal parts: 100 MΩ minimum Between terminals of different poles: 100 MΩ minimum
Contact Resistance	300 mΩ maximum (initial value, 1m cable) 500 mΩ maximum (initial value, 3m cable) 700 mΩ maximum (initial value, 5m cable)
Electric Shock Protection Class	Class II (IEC 61140)
Degree of Protection	IP67 (IEC 60529)
Shock Resistance	Operating extremes: 300 m/s <sup>2</sup> (30G) Damage limits: 1000 m/s <sup>2</sup> (100G)
Vibration Resistance	Operating extremes: 5 to 55 Hz, amplitude 0.5 mm Damage limits: 30 Hz, amplitude 1.5 mm
Actuator Operating Speed	0.05 to 1.0 m/s
Direct Opening Travel	8 mm minimum
Direct Opening Force	60N minimum
Operating Frequency	1200 operations/h
Mechanical Durability	1,000,000 operations minimum (GS-ET-15)
Electrical Durability	100,000 operations minimum (operating frequency 1200 operations/h, load AC-12 250V/1.5A, DC-12 250V/0.2A) 1,000,000 operations minimum (operating frequency 1200 operations/h, load 24V AC/DC, 100mA)
Conditional Short-circuit Current	50A (250V) (Use 250V/10A fast-blow fuse for short-circuit protection.)
Housing Color	Black
Cable	UL2464 No. 20 AWG (6-core)
Weight (approx.)	120g (HS6B-***01, cable length 1m) 270g (HS6B-***03, cable length 3m) 420g (HS6B-***05, cable length 5m)

Dimensions

Interlock Switch

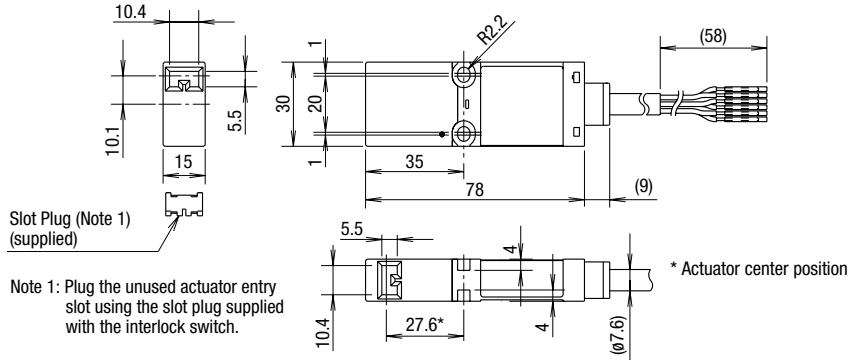

Mounting Hole Layout

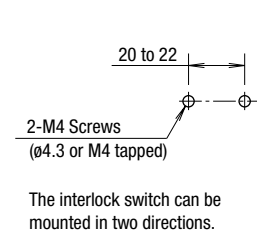

Using the HS9Z-A61 Straight Actuator

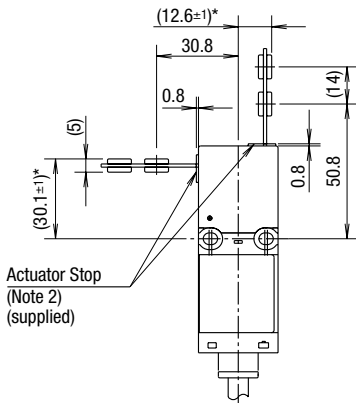

Using the HS9Z-A62 Right-angle Actuator

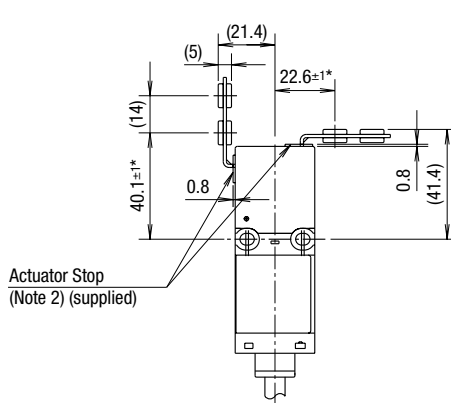

Using the HS9Z-A65/A66 Angle Adjustable Actuator

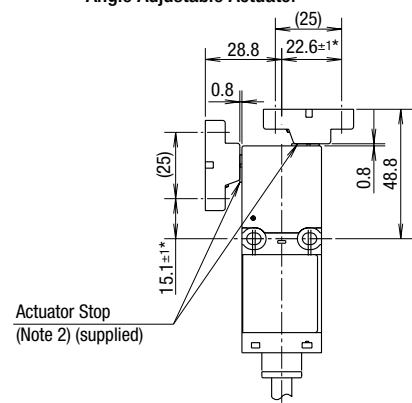

Contact Configuration and Operation Chart

Model	Contact Configuration	Contact Operation Chart
HS6B-11	1NC-1NO	
HS6B-02	2NC	
HS6B-12	2NC-1NO	
HS6B-03	3NC	

- The operation characteristics show the contact status when the actuator enters the entry slot of an interlock switch.
- See E-010 for wiring.

- APEM
- Switches & Pilot Lights
- Control Boxes
- Emergency Stop Switches
- Enabling Switches
- Safety Products
- Explosion Proof
- Terminal Blocks
- Relays & Sockets
- Circuit Protectors
- Power Supplies
- LED Illumination
- Controllers
- Operator Interfaces
- Sensors
- AUTO-ID

- Interlock Switches
- Non-contact Interlock Switches
- Safety Laser Scanners
- Safety Light Curtains
- Safety Modules
- HS6B
- HS6E
- HS5D
- HS5L
- HS1L
- Actuators for HS1/HS5/HS6
- Actuators/ Padlock Hasp

# HS6B Subminiature Interlock Switches

## Safety Precautions

- In order to avoid electric shock or fire, turn power off before installation, removal, wiring, maintenance, or inspection of the interlock switch.
- If relays are used in the circuit between the interlock switch and the load, use only safety relays, since welded or sticking contacts of standard relays may invalidate the functions of the interlock switch. Perform a risk assessment and make a safety circuit which satisfies the requirements of the safety category.

- Do not place a PLC in the circuit between the interlock switch and the load. Safety security can be endangered in the event of a malfunction of the PLC.
- Do not disassemble or modify the interlock switch, otherwise a malfunction or an accident may occur.
- Do not install the actuator in the location where a human body may come into contact. Otherwise injury may occur.

## Instructions

- Regardless of door types, do not use the interlock switch as a door stop. Install a mechanical door stop at the end of the door to protect the interlock switch against excessive force.
- Do not apply excessive shock to the interlock switch when opening or closing the door. A shock to the interlock switch exceeding 1,000 m/s<sup>2</sup> may cause damage to the interlock switch.
- If the operating atmosphere is contaminated, use a protective cover to prevent the entry of foreign objects into the interlock switch through the actuator entry slots.
- Entry of a considerable amount of foreign objects into the interlock switch may affect the mechanism of the interlock switch and cause a malfunction.
- Do not store the interlock switches in a dusty, humid, or organic-gas atmosphere.
- Use proprietary actuators only. When other actuators are used, the interlock switch may be damaged.
- Do not modify the actuator, otherwise it will damage the interlock switch.
- Cover the unused actuator entry slot using the slot plug supplied with the interlock switch.

- When the door hinged is on the extension line of the actuator mounting surface:

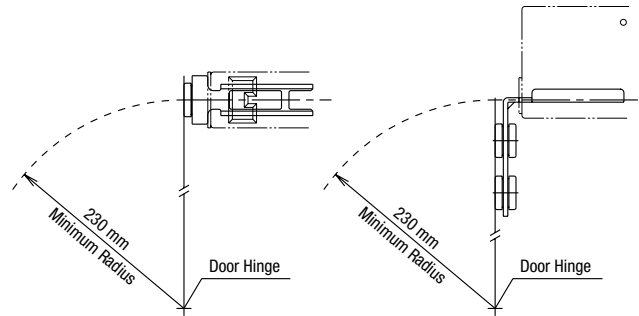

### When using the HS9Z-A65/HS9Z-A66 Angle Adjustable Actuator

- When the door hinge is on the extension line of the interlock switch surface:

#### Horizontal Adjustment

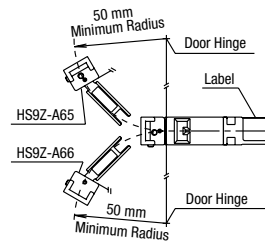

#### Vertical Adjustment

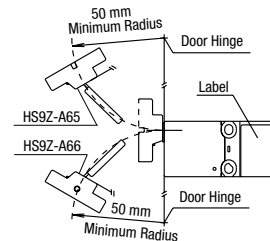

## Minimum Radius of Hinged Door

- When using the interlock switch on hinged doors, refer to the minimum radius of doors shown below. When using on doors with small minimum radius, use the angle adjustable actuator (HS9Z-A65 and HS9Z-A66).

Note: Because deviation or dislocation of hinged doors may occur in actual applications, make sure of the correct operation before installation.

### When using the HS9Z-A62 Right-angle Actuator

- When the door hinge is on the extension line of the interlock switch surface:

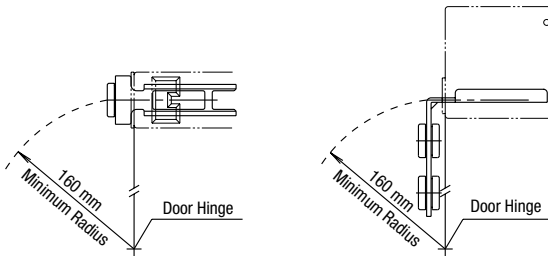

- When the door hinge is on the extension line of the actuator mounting surface

#### Horizontal Adjustment

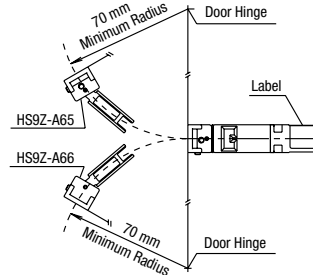

#### Vertical Adjustment

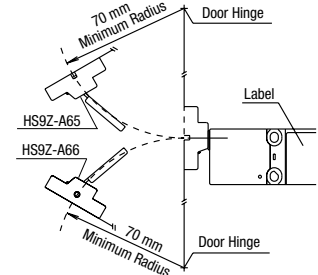

- APEM
- Switches & Pilot Lights
- Control Boxes
- Emergency Stop Switches
- Enabling Switches
- Safety Products
- Explosion Proof
- Terminal Blocks
- Relays & Sockets
- Circuit Protectors
- Power Supplies
- LED Illumination
- Controllers
- Operator Interfaces
- Sensors
- AUTO-ID
- Interlock Switches
- Non-contact Interlock Switches
- Safety Laser Scanners
- Safety Light Curtains
- Safety Modules

- HS6B
- HS6E
- HS5D
- HS5L
- HS1L
- Actuators for HS1/HS5/HS6
- Actuators/ Padlock Hasp

APEM

Switches & Pilot Lights

Control Boxes

Emergency Stop Switches

Enabling Switches

Safety Products

Explosion Proof

Terminal Blocks

Relays & Sockets

Circuit Protectors

Power Supplies

LED Illumination

Controllers

Operator Interfaces

Sensors

AUTO-ID

Interlock Switches

Non-contact Interlock Switches

Safety Laser Scanners

Safety Light Curtains

Safety Modules

HS6B

HS6E

HS5D

HS5L

HS1L

Actuators for HS1/HS5/HS6

Actuators/ Padlock Hasp

Instructions

Actuator Angle Adjustment for the HS9Z-A65/HS9Z-A66

- Using the angle adjustment screw, the actuator angle can be adjusted (see figures on page E-070). Adjustable angle: 0 to 20°
- The larger the adjusted angle of the actuator, the smaller the applicable radius of the door opening.
- After installing the actuator, open the door. Then adjust the actuator so that its edge can enter properly into the actuator entry slot of the interlock switch.
- After adjusting the actuator angle, apply Loctite to the adjustment screw so that the screw will not become loose.

Mounting

Mount the interlock switch on a fixated machine or guard, and mount the actuator on the hinged door. Do not mount both interlock switch and actuator on hinged doors, otherwise, malfunction will occur.

Note: When mounting an actuator, make sure that the actuator enters into the slot in the correct direction, as shown on the right.

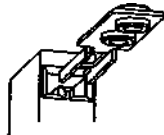

Recommended Screw Tightening Torque

- Interlock switch (M4 screw): 1.0 to 1.5 N·m
- Actuator (M4 screw): 1.0 to 1.5 N·m
- Mounting bolts are not supplied, and must be purchased separately by the user.

Note: The above recommended tightening torque of the mounting screw is the value with hex socket head bolts. When other screws are used and tightened to a smaller torque, make sure that the screws do not become loose after mounting.

Cable

- Do not fasten or loosen the gland at the bottom of the interlock switch.
- When bending cable during wiring, make sure that the cable radius is kept at 40 mm minimum.
- When wiring, make sure that water or oil does not enter from the end of cable.

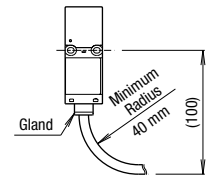

Wire Identification

- Wires can be identified by color and/or a white line printed on the wire.

No.	Insulation Color	No.	Insulation Color
1	Orange/White	4	Brown
2	Blue/White	5	Blue
3	Brown/White	6	Orange

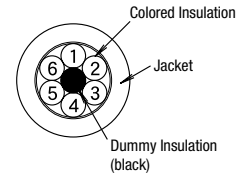

Terminal Number Identification

- When wiring, the terminal number on each contact can be identified by wire color.
- The following diagrams show a safety (main) contact and one or two auxiliary contacts for two-contact and three-contact types.

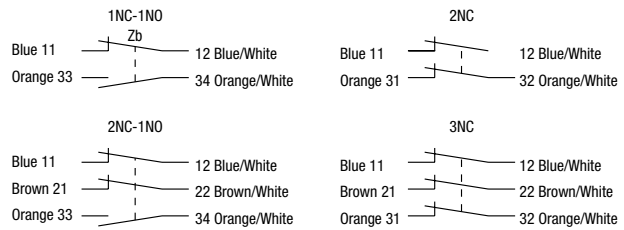

- When wiring, cut any dummy insulation (black) and any unused wires at the end of the jacket to avoid incorrect wiring.

# HS6E Subminiature Interlock Switches with Solenoid

**Small interlock switch with five poles and solenoid.**  
**Ideal for applications in tight spaces.**

- Compact body: 75 × 15 × 75 mm, 15-mm-wide
- Reversible mounting and angled cable allow four actuator insertion directions.
- Energy saving. 24V DC, 110 mA (solenoid: 100 mA, LED: 10 mA). Can be driven directly by a controller.
- Manual unlocking possible on three sides.
- LED indicator shows solenoid operation

## Spring Lock

- Automatically locks the actuator without power applied to the solenoid.
- After the machine stops, unlocking is completed by the solenoid.
- Manual unlocking is possible on three sides in the event of power failure or maintenance.

## Solenoid Lock

- The actuator is locked when energized.
- The actuator is unlocked when de-energized.
- Flexible locking function can be achieved, for an application where locking is not required and sudden stopping of a machine must be prevented.

## Ratings

### Contact Ratings

Rated Insulation Voltage (Ui) (Note 1)		300V (door monitor contact) 150V (lock monitor contact) 30V (between LED or solenoid and ground)				
Rated Thermal Current (Ith)		Operating temperature -25 to 35°C 2.5A (up to 2 circuits) 1.0A (3 or more circuits) Operating temperature 35 to 50°C 1.0A (1 circuit) 0.5A (2 or more circuits)				
Rated Voltage (Ue)		30V	125V	250V		
Rated Current (Ie)*	Main & Lock Monitor Circuits	AC	Resistive load (AC-12)	—	2A	—
			Inductive Load (AC-15)	—	1A	—
		DC	Resistive load (DC-12)	2A	0.4A	—
	Inductive Load (DC-13)		1A	0.22A	—	
	Door Monitor Circuit	AC	Resistive load (AC-12)	—	2.5A	1.5A
			Inductive Load (AC-15)	—	1.5A	0.75A
DC		Resistive load (DC-12)	2.5A	1.1A	0.55A	
		Inductive Load (DC-13)	2.3A	0.55A	0.27A	

- Minimum applicable load (reference value): 3V AC/DC, 5 mA

### Approved ratings

	TÜV	UL/c-UL	CCC
Door Monitor Contact	AC-15 240V/0.75A DC-13 250V/0.27A DC-13 30V/2.3A	240V AC/0.75A Pilot Duty 250V DC/0.27A Pilot Duty C300 Q300	AC-15 240V/0.75A DC-13 30V/2.3A
Lock Monitor Contact	AC-15 125V/1A DC-13 125V/0.22A DC-13 30V/1A	125V AC/1A Pilot Duty 125V DC/0.22A Pilot Duty DC-13 30V/1A Pilot Duty	AC-15 125V/1A DC-13 30V/1A

### Solenoid/Indicator

Locking Mechanism	Spring Lock	Solenoid Lock
Rated Voltage	24V DC (100% duty cycle)	
Rated Current	110 mA (solenoid 100 mA, LED 10 mA) (initial value)	
Solenoid	Coil Resistance	240Ω (at 20°C)
	Pickup Voltage	Rated voltage × 85% maximum (at 20°C)
	Dropout Voltage	Rated voltage × 10% minimum (at 20°C)
	Maximum Continuous Applicable Voltage	Rated voltage × 110%
	Maximum Continuous Applicable Time	Continuous
	Insulation Class	Class F
Indicator	Light Source	LED
	Illumination Color	Green

Right-angle Actuator (SUS304)

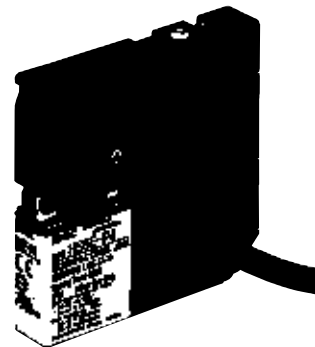

## Specifications

Applicable Standards	ISO14119 IEC60947-5-1 (TÜV approved) EN60947-5-1 (TÜV approved) GS-ET-19 (TÜV approved) UL508 (c-UL listed) CSA C22.2 No. 14 (c-UL listed) GB/T14048.5 (CCC approved) KS C IEC60947-5-1/S1-G-1/S2-E-4 (KOSHA approved) IEC 60204-1/EN 60204-1 (applicable standards for use)
Operating Temperature	-25 to +50°C (no freezing)
Relative Humidity	45 to 85% (no condensation)
Storage Temperature	-40 to +80°C (no freezing)
Pollution Degree	3
Impulse Withstand Voltage	Main & lock monitor circuits: 1.5 kV Door monitor circuit: 2.5 kV Between solenoid/LED and ground: 0.5 kV
Insulation Resistance (500V DC megger)	Between live and dead metal parts: 100 MΩ minimum Between terminals of different poles: 100 MΩ minimum
Contact Resistance	300 mΩ maximum (initial value, 1m cable) 500 mΩ maximum (initial value, 3m cable) 700 mΩ maximum (initial value, 5m cable)
Electric Shock Protection	Class II (IEC 61140)
Degree of Protection	IP67 (IEC 60529)
Shock Resistance	Operating extremes: 100 m/s <sup>2</sup> (10G) Damage limits: 1000 m/s <sup>2</sup> (100G)
Vibration Resistance	Operating extremes: 10 to 55 Hz, amplitude 0.35 mm Damage limits: 30 Hz, amplitude 1.5 mm
Actuator Operating Speed	0.05 to 1.0 m/s
Direct Opening Travel	8.0 mm minimum
Direct Opening Force	60N minimum
Actuator Retention Force (*1)	500N minimum (GS-ET-19)
Operating Frequency	900 operations/h
Mechanical Durability	1,000,000 operations minimum (GS-ET-19)
Electrical Durability	100,000 operations minimum (rated load) 1,000,000 operations minimum (24V AC/DC, 100 mA) (operating frequency 900 operations/h)
Conditional Short-circuit Current	50A (250V) (Use 250V/10A fast-blow fuse for short-circuit protection.)
Cable	UL2464, No. 22 AWG (12-core: 0.3 mm <sup>2</sup> or equivalent/core)
Cable Diameter	ø7.6 mm
Weight (approx.)	220g (1m cable) 410g (3m cable) 600g (5m cable)

\*1) See E-014 for actuator retention force.

Standard

Package Quantity: 1

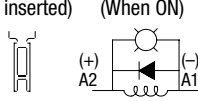
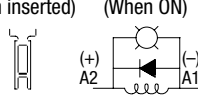
Lock Mechanism	Circuit Number	Contact Configuration	Cable Length	Part No.	
Spring Lock	L	(When inserted) (When ON) 	1m	HS6E-L44B01-G	
		3m	HS6E-L44B03-G		
		5m	HS6E-L44B05-G		
	M	Main Circuit: 1NC+1NC, Door Monitor Circuit: 2NC Lock Monitor Circuit: 1NO	Main Circuit: ①11 12 41 42 Monitor Circuit: ②21 22 53 54 Monitor Circuit: ③31 32	1m	HS6E-M44B01-G
		3m	HS6E-M44B03-G		
		5m	HS6E-M44B05-G		
	N	Main Circuit: 1NC+1NC, Door Monitor Circuit: 1NC, 1NO Lock Monitor Circuit: 1NO	Main Circuit: ①11 12 41 42 Monitor Circuit: ②21 22 53 54 Monitor Circuit: 33 34	1m	HS6E-N44B01-G
		3m	HS6E-N44B03-G		
		5m	HS6E-N44B05-G		
	P	Main Circuit: 1NC+1NC, Door Monitor Circuit: 1NC, 1NO Lock Monitor Circuit: 1NC	Main Circuit: ①11 12 41 42 Monitor Circuit: ②21 22 51 52 Monitor Circuit: 33 34	1m	HS6E-P44B01-G
		3m	HS6E-P44B03-G		
		5m	HS6E-P44B05-G		
Solenoid Lock	L	(When inserted) (When ON) 	1m	HS6E-L7Y4B01-G	
		3m	HS6E-L7Y4B03-G		
		5m	HS6E-L7Y4B05-G		
	M	Main Circuit: 1NC+1NC, Door Monitor Circuit: 2NC Lock monitor Circuit: 1NC	Main Circuit: ①11 12 41 42 Monitor Circuit: ②21 22 51 52 Monitor Circuit: ③31 32	1m	HS6E-M7Y4B01-G
		3m	HS6E-M7Y4B03-G		
		5m	HS6E-M7Y4B05-G		
	N	Main Circuit: 1NC+1NC, Door Monitor Circuit: 1NC, 1NO Lock Monitor Circuit: 1NO	Main Circuit: ①11 12 41 42 Monitor Circuit: ②21 22 53 54 Monitor Circuit: 33 34	1m	HS6E-N7Y4B01-G
		3m	HS6E-N7Y4B03-G		
		5m	HS6E-N7Y4B05-G		
	P	Main Circuit: 1NC+1NC, Door Monitor Circuit: 1NC, 1NO Lock Monitor Circuit: 1NC	Main Circuit: ①11 12 41 42 Monitor Circuit: ②21 22 51 52 Monitor Circuit: 33 34	1m	HS6E-P7Y4B01-G
		3m	HS6E-P7Y4B03-G		
		5m	HS6E-P7Y4B05-G		

- The contact configurations show the contact status when the actuator is inserted and locked.
- LED color is G (green) only.
- Actuators are not supplied with the interlock switch and must be ordered separately.
- See E-022 for wiring.

APEM

Switches & Pilot Lights

Control Boxes

Emergency Stop Switches

Enabling Switches

Safety Products

Explosion Proof

Terminal Blocks

Relays & Sockets

Circuit Protectors

Power Supplies

LED Illumination

Controllers

Operator Interfaces

Sensors

AUTO-ID

Interlock Switches

Non-contact Interlock Switches

Safety Laser Scanners

Safety Light Curtains

Safety Modules

HS6B

HS6E

HS5D

HS5L

HS1L

Actuators for HS1/HS5/HS6

Actuators/ Padlock Hasp



# HS6E Subminiature Interlock Switches with Solenoid





Package Quantity: 1

## 5-circuit Independent Output

Lock Mechanism	Circuit Number	Contact Configuration	Cable Length	Part No.
Spring Lock	VL	<p>Door monitor circuit: 3NC Lock monitor circuit: 1NC, 1NO</p> <p>Monitor Circuit: 11 12 41 42                      Monitor Circuit: 21 22 53 54                      Monitor Circuit: 31 32</p>	1m	HS6E-VL44B01-G
			3m	HS6E-VL44B03-G
			5m	HS6E-VL44B05-G
	VM	<p>Door monitor circuit: 3NC Lock monitor circuit: 2NC</p> <p>Monitor Circuit: 11 12 41 42                      Monitor Circuit: 21 22 51 52                      Monitor Circuit: 31 32</p>	1m	HS6E-VM44B01-G
			3m	HS6E-VM44B03-G
			5m	HS6E-VM44B05-G
	VN	<p>Door monitor circuit: 2NC, 1NO Lock monitor circuit: 1NC, 1NO</p> <p>Monitor Circuit: 11 12 41 42                      Monitor Circuit: 21 22 53 54                      Monitor Circuit: 33 34</p>	1m	HS6E-VN44B01-G
			3m	HS6E-VN44B03-G
			5m	HS6E-VN44B05-G
	VP	<p>Door monitor circuit: 2NC, 1NO Lock monitor circuit: 2NC</p> <p>Monitor Circuit: 11 12 41 42                      Monitor Circuit: 21 22 51 52                      Monitor Circuit: 33 34</p>	1m	HS6E-VP44B01-G
			3m	HS6E-VP44B03-G
			5m	HS6E-VP44B05-G
Solenoid Lock	VL	<p>Door monitor circuit: 3NC Lock monitor circuit: 1NC, 1NO</p> <p>Monitor Circuit: 11 12 41 42                      Monitor Circuit: 21 22 53 54                      Monitor Circuit: 31 32</p>	1m	HS6E-VL7Y4B01-G
			3m	HS6E-VL7Y4B03-G
			5m	HS6E-VL7Y4B05-G
	VM	<p>Door monitor circuit: 3NC Lock monitor circuit: 2NC</p> <p>Monitor Circuit: 11 12 41 42                      Monitor Circuit: 21 22 51 52                      Monitor Circuit: 31 32</p>	1m	HS6E-VM7Y4B01-G
			3m	HS6E-VM7Y4B03-G
			5m	HS6E-VM7Y4B05-G
	VN	<p>Door monitor circuit: 2NC, 1NO Lock monitor circuit: 1NC, 1NO</p> <p>Monitor Circuit: 11 12 41 42                      Monitor Circuit: 21 22 53 54                      Monitor Circuit: 33 34</p>	1m	HS6E-VN7Y4B01-G
			3m	HS6E-VN7Y4B03-G
			5m	HS6E-VN7Y4B05-G
	VP	<p>Door monitor circuit: 2NC, 1NO Lock monitor circuit: 2NC</p> <p>Monitor Circuit: 11 12 41 42                      Monitor Circuit: 21 22 51 52                      Monitor Circuit: 33 34</p>	1m	HS6E-VP7Y4B01-G
			3m	HS6E-VP7Y4B03-G
			5m	HS6E-VP7Y4B05-G

- The contact configurations show the contact status when the actuator is inserted and locked.
- LED color is G (green) only.
- Actuators are not supplied with the interlock switch and must be ordered separately.
- See E-022 for wiring.

Actuator

Shape	Part No.	Remarks
	HS9Z-A61	The retention force of HS9Z-A61 actuator is 500N maximum. Do no apply excessive load, otherwise the actuator may fall off the door.
	HS9Z-A62	The retention force of HS9Z-A62 actuator is 100N maximum. Do no apply excessive load, otherwise the actuator may fall off the door. When retention force of 100N or more is required, use the HS9Z-A62S actuator.
	HS9Z-A62S	The retention force of HS9Z-A62S actuator is 500N maximum. Do no apply excessive load, otherwise the actuator may fall off the door.
	HS9Z-A65	The HS9Z-A65 and HS9Z-A66 have the metal key installed in opposite directions. The retention force of HS9Z-A65 and HS9Z-A66 actuators is 500N maximum.
	HS9Z-A66	

- Select actuator by determining the required moving direction in consideration of the door and interlock switch. (See E-020 to E-021)
- See E-069 for details on actuators.

Part No. Development

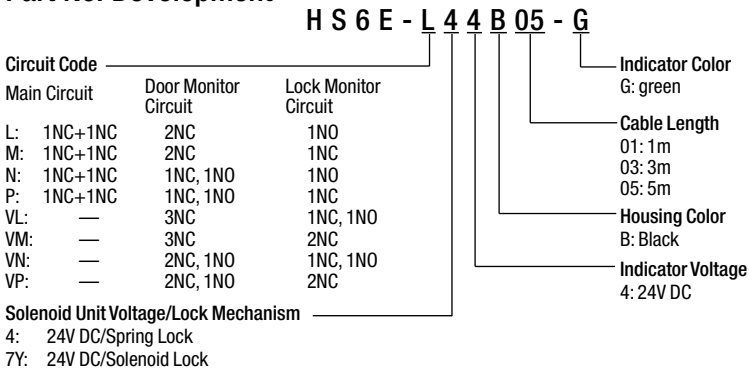

- APM
- Switches & Pilot Lights
- Control Boxes
- Emergency Stop Switches
- Enabling Switches
- Safety Products
- Explosion Proof
- Terminal Blocks
- Relays & Sockets
- Circuit Protectors
- Power Supplies
- LED Illumination
- Controllers
- Operator Interfaces
- Sensors
- AUTO-ID
- Interlock Switches
- Non-contact Interlock Switches
- Safety Laser Scanners
- Safety Light Curtains
- Safety Modules

Accessory

Description	Part No.
Manual Unlock Key (long)	HS9Z-T3

Manual Unlock Key (supplied) (plastic)

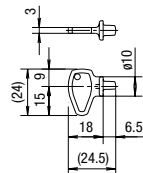

Manual Unlock Key (long) (metal)

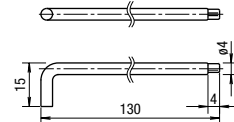

All dimensions in mm.

- HS6B
- HS6E
- HS5D
- HS5L
- HS1L
- Actuators for HS1/HS5/HS6
- Actuators/Padlock Hasp

# HS6E Subminiature Interlock Switches with Solenoid

## Dimensions

### Interlock Switch

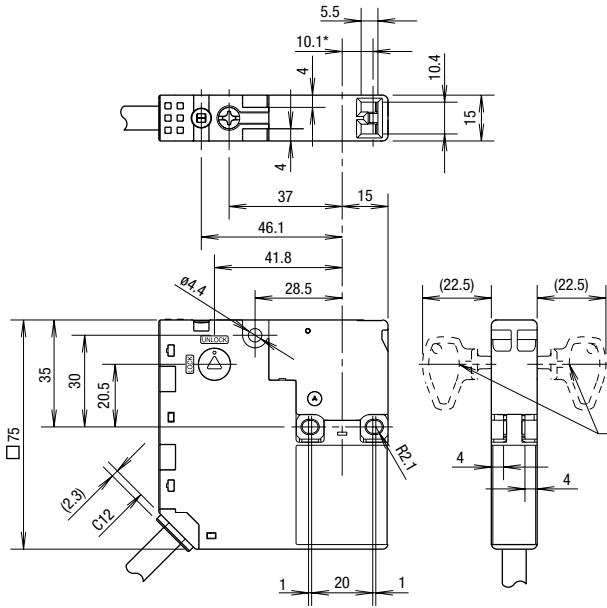

\* Actuator center

### • Mounting Hole Layout

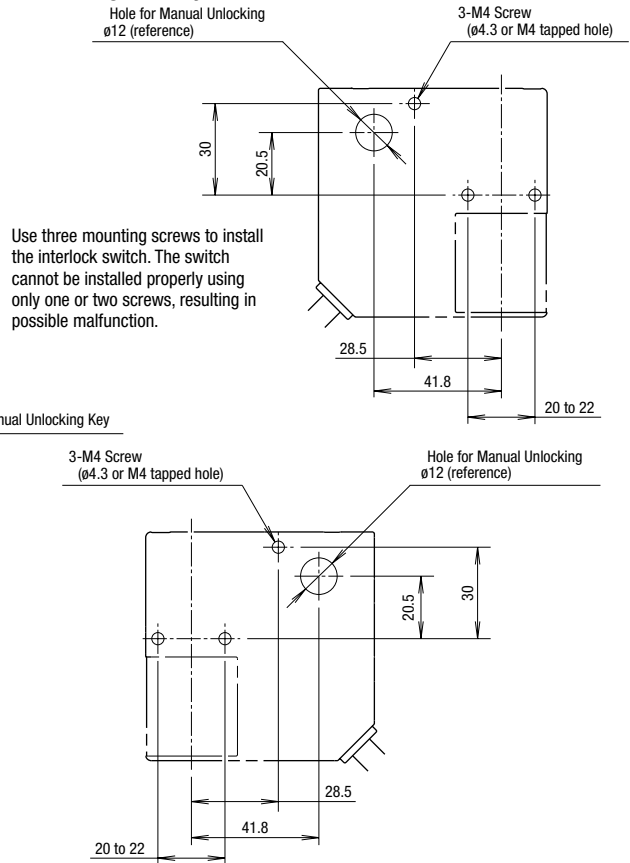

Use three mounting screws to install the interlock switch. The switch cannot be installed properly using only one or two screws, resulting in possible malfunction.

### When using straight actuator (HS9Z-A61)

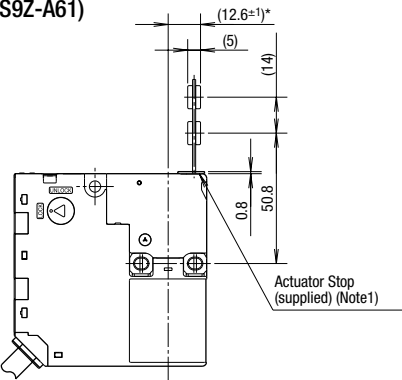

### When using right-angle actuator (HS9Z-A62S)

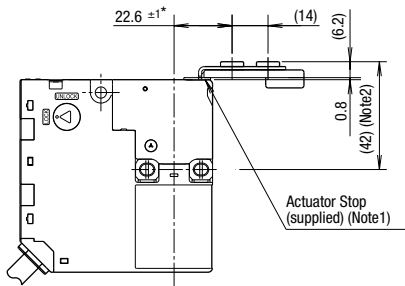

### When using horizontal/vertical angle adjustable actuator (HS9Z-A65/A66)

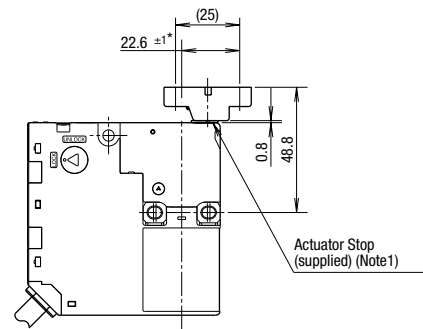

Note 1: Remove the actuator stop after mounting the actuator.

Note 2: 41.4 when using HS9Z-A62.

\* The retention force of the HS9Z-A62 actuator is 100N. When tensile force exceeding 100N is expected, use the HS9Z-A62S actuator (with a mounting plate).

### Actuator Mounting Reference Position

As shown in the figure on the right, the mounting reference position of the actuator when inserted in the interlock switch is:

The actuator stop on the actuator lightly touches the interlock switch.

Note: After mounting the actuator, remove the actuator stop from the actuator.

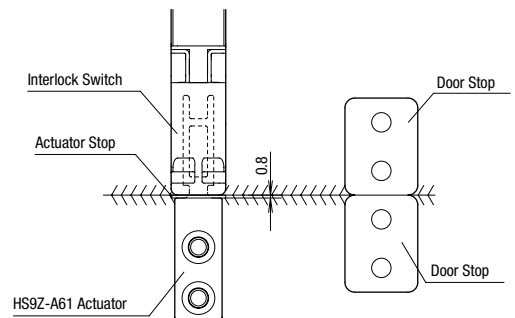

Circuit Diagrams and Operating Characteristics

Standard – Spring Lock

Interlock Switch Status	Status 1	Status 2	Status 3	Status 4	Unlocking using Manual Unlock Key	
	<ul style="list-style-type: none"> <li>Door closed</li> <li>Machine ready to operate</li> <li>Solenoid de-energized</li> </ul>	<ul style="list-style-type: none"> <li>Door closed</li> <li>Machine cannot be operated</li> <li>Solenoid energized</li> </ul>	<ul style="list-style-type: none"> <li>Door open</li> <li>Machine cannot be operated</li> <li>Solenoid energized</li> </ul>	<ul style="list-style-type: none"> <li>Door open</li> <li>Machine cannot be operated</li> <li>Solenoid de-energized</li> </ul>		<ul style="list-style-type: none"> <li>Door closed</li> <li>Machine cannot be operated</li> <li>Solenoid de-energized</li> </ul>
Door Status						
Circuit Diagram (Example: HS6E-N4)						
Door	Closed (locked)	Closed (unlocked)	Open	Open	Closed (unlocked)	
Model and Circuit Diagram	<b>HS6E-L4</b> (When inserted) Door Monitor (When ON) Lock Monitor  Main Circuit: 11-12 41-42 Monitor Circuit: 21-22 53-54 Monitor Circuit: 31-32	Main Circuit 11-42				
		Door Monitor Circuit (door closed) 21-22				
		Door Monitor Circuit (door closed) 31-32				
		Lock Monitor Circuit (unlocked) 53-54				
	<b>HS6E-M4</b> Main Circuit: 11-12 41-42 Monitor Circuit: 21-22 51-52 Monitor Circuit: 31-32	Main Circuit 11-42				
		Door Monitor Circuit (door closed) 21-22				
		Door Monitor Circuit (door closed) 31-32				
		Lock Monitor Circuit (locked) 51-52				
	<b>HS6E-N4</b> Main Circuit: 11-12 41-42 Monitor Circuit: 21-22 53-54 Monitor Circuit: 33-34	Main Circuit 11-42				
		Door Monitor Circuit (door closed) 21-22				
		Door Monitor Circuit (door open) 33-34				
		Lock Monitor Circuit (unlocked) 53-54				
	<b>HS6E-P4</b> Main Circuit: 11-12 41-42 Monitor Circuit: 21-22 51-52 Monitor Circuit: 33-34	Main Circuit 11-42				
		Door Monitor Circuit (door closed) 21-22				
		Door Monitor Circuit (door open) 33-34				
		Lock Monitor Circuit (locked) 51-52				
Solenoid Power A1-A2 (all model)	OFF (de-energized)	ON (energized)	ON (energized)	OFF (de-energized)	OFF (de-energized)	

Main circuit: Connected to the machine drive control circuit, sending the interlock signals of the protective door.  
 Monitor circuit: Sends the monitoring signals of open/closed and lock/unlocked statuses of the protective door.

Operation Characteristics (reference)

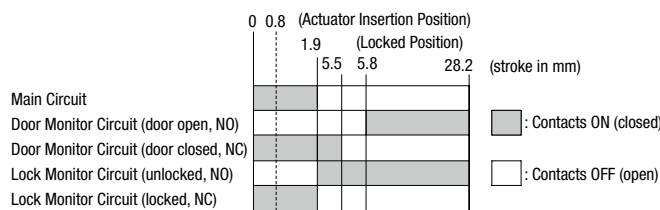

- The characteristics shown in the chart above are of the HS9Z-A61, -A62, -A65, and -A66 actuators. For the HS9Z-A62S actuator, subtract 0.6 mm.
- The characteristics show the contact status when the actuator enters an entry slot of an interlock switch.

- APEM
- Switches & Pilot Lights
- Control Boxes
- Emergency Stop Switches
- Enabling Switches
- Safety Products
- Explosion Proof
- Terminal Blocks
- Relays & Sockets
- Circuit Protectors
- Power Supplies
- LED Illumination
- Controllers
- Operator Interfaces
- Sensors
- AUTO-ID
- Interlock Switches
- Non-contact Interlock Switches
- Safety Laser Scanners
- Safety Light Curtains
- Safety Modules

- HS6B
- HS6E
- HS5D
- HS5L

- HS1L
- Actuators for HS1/HS5/HS6
- Actuators/ Padlock Hasp

# HS6E Subminiature Interlock Switches with Solenoid

## Standard – Solenoid Lock

		Status 1	Status 2	Status 3	Status 4	Unlocking using Manual Unlock Key	
Interlock Switch Status		<ul style="list-style-type: none"> <li>Door closed</li> <li>Machine ready to operate</li> <li>Solenoid energized</li> </ul>	<ul style="list-style-type: none"> <li>Door closed</li> <li>Machine cannot be operated</li> <li>Solenoid de-energized</li> </ul>	<ul style="list-style-type: none"> <li>Door open</li> <li>Machine cannot be operated</li> <li>Solenoid de-energized</li> </ul>	<ul style="list-style-type: none"> <li>Door open</li> <li>Machine cannot be operated</li> <li>Solenoid energized</li> </ul>	<ul style="list-style-type: none"> <li>Door closed</li> <li>Machine cannot be operated</li> <li>Solenoid de-energized</li> </ul>	
Door Status							
Circuit Diagram (Example: HS6E-N7Y)							
Door		Closed (locked)	Closed (unlocked)	Open	Open	Closed (unlocked)	
Model and Circuit Diagram	<b>HS6E-L7Y</b> (When inserted) (When ON)  Main Circuit: 11-12 41-42 Monitor Circuit: 21-22 53-54 Lock Monitor Circuit: 31-32		Main Circuit 11-42				
			Door Monitor Circuit (door closed) 21-22				
			Door Monitor Circuit (door closed) 31-32				
			Lock Monitor Circuit (unlocked) 53-54				
	<b>HS6E-M7Y</b>  Main Circuit: 11-12 41-42 Monitor Circuit: 21-22 51-52 Lock Monitor Circuit: 31-32		Main Circuit 11-42				
			Door Monitor Circuit (door closed) 21-22				
			Door Monitor Circuit (door closed) 31-32				
			Lock Monitor Circuit (locked) 51-52				
	<b>HS6E-N7Y</b>  Main Circuit: 11-12 41-42 Monitor Circuit: 21-22 53-54 Lock Monitor Circuit: 33-34		Main Circuit 11-42				
			Door Monitor Circuit (door closed) 21-22				
			Door Monitor Circuit (door open) 33-34				
			Lock Monitor Circuit (unlocked) 53-54				
	<b>HS6E-P7Y</b>  Main Circuit: 11-12 41-42 Monitor Circuit: 21-22 51-52 Lock Monitor Circuit: 33-34		Main Circuit 11-42				
			Door Monitor Circuit (door closed) 21-22				
			Door Monitor Circuit (door open) 33-34				
			Lock Monitor Circuit (locked) 51-52				
Solenoid Power A1-A2 (all model)		ON (energized)	OFF (de-energized)	OFF (de-energized)	ON (energized) (Note 2)	OFF (de-energized) to ON (re-energized) (Note 1) (Note 2)	

HS5L Main circuit: Connected to the machine drive control circuit, sending the interlock signals of the protective door.

HS5L Monitor circuit: Sends the monitoring signals of open/closed and lock/unlocked statuses of the protective door.

HS1L Note 1: Do not attempt manual unlocking while the solenoid is energized.

HS1L Note 2: Do not energize the solenoid for a long period of time while the door is open or while the door is unlocked manually using the manual unlock key.

### Operation Characteristics (reference)

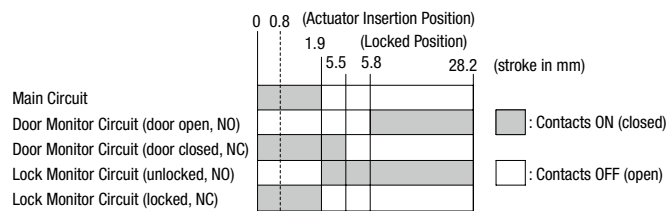

• The characteristics shown in the chart above are of the HS9Z-A61, -A62, -A65, and -A66 actuators.

For the HS9Z-A62S actuator, subtract 0.6 mm.

• The characteristics show the contact status when the actuator enters an entry slot of an interlock switch.

5-circuit Independent Output – Spring Lock

		Status 1	Status 2	Status 3	Status 4	Unlocking using Manual Unlock Key	
Interlock Switch Status		<ul style="list-style-type: none"> <li>Door closed</li> <li>Machine ready to operate</li> <li>Solenoid energized</li> </ul>	<ul style="list-style-type: none"> <li>Door closed</li> <li>Machine cannot be operated</li> <li>Solenoid energized</li> </ul>	<ul style="list-style-type: none"> <li>Door open</li> <li>Machine cannot be operated</li> <li>Solenoid energized</li> </ul>	<ul style="list-style-type: none"> <li>Door open</li> <li>Machine cannot be operated</li> <li>Solenoid de-energized</li> </ul>	<ul style="list-style-type: none"> <li>Door closed</li> <li>Machine cannot be operated</li> <li>Solenoid de-energized</li> </ul>	
Door Status							
Circuit Diagram (Example: HS6E-VN4)							
Door		Closed (locked)	Closed (unlocked)	Open	Open	Closed (unlocked)	
Model and Contact Configuration	HS6E-VL4 	Door Monitor Circuit (door closed) 11-12					
		Door Monitor Circuit (door closed) 21-22					
	Door Monitor Circuit (door closed) 31-32						
	Lock Monitor Circuit (locked) 41-42						
	Lock Monitor Circuit (unlocked) 53-54						
	HS6E-VM4 	Door Monitor Circuit (door closed) 11-12					
		Door Monitor Circuit (door closed) 21-22					
	Door Monitor Circuit (door closed) 31-32						
	Lock Monitor Circuit (locked) 41-42						
	Lock Monitor Circuit (locked) 51-52						
	HS6E-VN4 	Door Monitor Circuit (door closed) 11-12					
		Door Monitor Circuit (door closed) 21-22					
		Door Monitor Circuit (door open) 33-34					
		Lock Monitor Circuit (locked) 41-42					
	Lock Monitor Circuit (unlocked) 53-54						
	HS6E-VP4 	Door Monitor Circuit (door closed) 11-12					
Door Monitor Circuit (door closed) 21-22							
Door Monitor Circuit (door open) 33-34							
Lock Monitor Circuit (locked) 41-42							
Lock Monitor Circuit (locked) 51-52							
Solenoid Power A1-A2 (all model)		OFF (de-energized)	ON (energized)	ON (energized)	OFF (de-energized)	OFF (de-energized)	

Monitor circuit: Sends the monitoring signals of open/closed and lock/unlocked statuses of the protective door.

Operation Characteristics (reference)

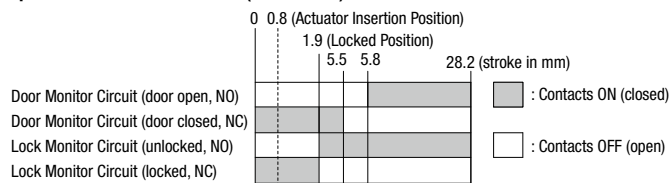

- The characteristics shown in the chart above are of the HS9Z-A61, -A62, -A65, and -A66 actuators. For the HS9Z-A62S actuator, subtract 0.6 mm.
- The characteristics show the contact status when the actuator enters an entry slot of an interlock switch.

- APEM
- Switches & Pilot Lights
- Control Boxes
- Emergency Stop Switches
- Enabling Switches
- Safety Products
- Explosion Proof
- Terminal Blocks
- Relays & Sockets
- Circuit Protectors
- Power Supplies
- LED Illumination
- Controllers
- Operator Interfaces
- Sensors
- AUTO-ID
- Interlock Switches
- Non-contact Interlock Switches
- Safety Laser Scanners
- Safety Light Curtains
- Safety Modules
- HS6B
- HS6E
- HS5D
- HS5L
- HS1L
- Actuators for HS1/HS5/HS6
- Actuators/ Padlock Hasp

# HS6E Subminiature Interlock Switches with Solenoid

## 5-circuit Independent Output – Solenoid Lock

	Status 1	Status 2	Status 3	Status 4	When using Manual Unlock Key	
Interlock Switch Status	<ul style="list-style-type: none"> <li>Door closed</li> <li>Machine ready to operate</li> <li>Solenoid energized</li> </ul>	<ul style="list-style-type: none"> <li>Door closed</li> <li>Machine cannot be operated</li> <li>Solenoid de-energized</li> </ul>	<ul style="list-style-type: none"> <li>Door closed</li> <li>Machine cannot be operated</li> <li>Solenoid de-energized</li> </ul>	<ul style="list-style-type: none"> <li>Door open</li> <li>Machine cannot be operated</li> <li>Solenoid energized</li> </ul>	<ul style="list-style-type: none"> <li>Door closed</li> <li>Machine cannot be operated</li> <li>Solenoid de-energized → energized</li> </ul>	
Door Status						
Circuit Diagram (Example: HS6E-VN7Y)						
Door	Closed (locked)	Closed (unlocked)	Open	Open	Closed (unlocked)	
Model and Contact Configuration	<b>HS6E-VL7Y</b> Door Monitor (When inserted) Lock Monitor (When ON) Monitor Circuit: ⊕11-12 41-42 Monitor Circuit: ⊕21-22 53-54 Monitor Circuit: ⊕31-32	Door Monitor Circuit (door closed) 11-12				
		Door Monitor Circuit (door closed) 21-22				
		Door Monitor Circuit (door closed) 31-32				
		Lock Monitor Circuit (locked) 41-42				
	<b>HS6E-VM7Y</b> Monitor Circuit: ⊕11-12 41-42 Monitor Circuit: ⊕21-22 51-52 Monitor Circuit: ⊕31-32	Door Monitor Circuit (door closed) 11-12				
		Door Monitor Circuit (door closed) 21-22				
		Door Monitor Circuit (door closed) 31-32				
		Lock Monitor Circuit (locked) 41-42				
	<b>HS6E-VN7Y</b> Monitor Circuit: ⊕11-12 41-42 Monitor Circuit: ⊕21-22 53-54 Monitor Circuit: 33-34	Door Monitor Circuit (door closed) 11-12				
		Door Monitor Circuit (door closed) 21-22				
		Door Monitor Circuit (door open) 33-34				
		Lock Monitor Circuit (locked) 41-42				
	<b>HS6E-VP7Y</b> Monitor Circuit: ⊕11-12 41-42 Monitor Circuit: ⊕21-22 51-52 Monitor Circuit: 33-34	Door Monitor Circuit (door closed) 11-12				
		Door Monitor Circuit (door closed) 21-22				
		Door Monitor Circuit (door open) 33-34				
		Lock Monitor Circuit (locked) 41-42				
<b>Solenoid Power A1-A2 (all model)</b>	ON (energized)	OFF (de-energized)	OFF (de-energized)	ON (energized) (Note 2)	(Note 1) (Note 2) OFF (de-energized) → ON (energized)	

Monitor circuit: Sends the monitoring signals of open/closed and lock/unlocked statuses of the protective door.

Note 1: Do not attempt manual unlocking while the solenoid is energized.

Note 2: Do not energize the solenoid for a long period of time while the door is open or while the door is unlocked manually using the manual unlock key.

### Operation Characteristics (reference)

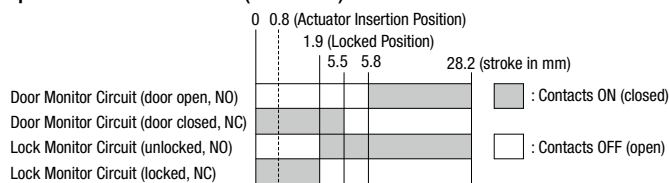

• The characteristics shown in the chart above are of the HS9Z-A61, -A62, -A65, and -A66 actuators. For the HS9Z-A62S actuator, subtract 0.6 mm.

• The characteristics show the contact status when the actuator enters an entry slot of an interlock switch.

APEM
Switches & Pilot Lights
Control Boxes
Emergency Stop Switches
Enabling Switches
Safety Products
Explosion Proof
Terminal Blocks
Relays & Sockets
Circuit Protectors
Power Supplies
LED Illumination
Controllers
Operator Interfaces
Sensors
AUTO-ID
Interlock Switches
Non-contact Interlock Switches
Safety Laser Scanners
Safety Light Curtains
Safety Modules
HS6B
HS6E
HS5D
HS5L
HS1L
Actuators for HS1/HS5/HS6
Actuators/ Padlock Hasp

**⚠ Safety Precautions**

- In order to avoid electric shock or fire, turn power off before installation, removal, wiring, maintenance, or inspection of the interlock switch.
- If relays are used in the circuit between the interlock switch and the load, use only safety relays, since welded or sticking contacts of standard relays may invalidate the functions of the interlock switch. Perform a risk assessment and make a safety circuit which satisfies the requirements of the safety category.
- Do not place a PLC in the circuit between the interlock switch and the load. Safety security can be endangered in the event of a malfunction of the PLC.

**Instructions**

- Regardless of door types, do not use the interlock switch as a door stop. Install a mechanical door stop at the end of the door to protect the interlock switch against excessive force.
- Do not apply excessive shock to the interlock switch when opening or closing the door. A shock to the interlock switch exceeding 1,000 m/s<sup>2</sup> may cause damage to the interlock switch.
- When unlocking, the switch may not be unlocked if a load is applied to the actuator.
- If the operating atmosphere is contaminated, use a protective cover to prevent the entry of foreign objects into the interlock switch through the actuator entry slots.
- Entry of a considerable amount of foreign objects into the interlock switch may affect the mechanism of the interlock switch and cause a malfunction.
- Do not store the interlock switches in a dusty, humid, or organic-gas atmosphere, or in an area subjected to direct sunlight.
- Use dedicated actuators only. When other actuators are used, the interlock switch may be damaged.
- For correct operation, install the interlock switch on a flat surface and provide sufficient strength to the surface so that it is not disfigured. Do not insert any object between the interlock switch and installation surface.
- Do not cut the actuator. modification of the actuator may cause damage.
- The locking strength is rated at 500N. Do not apply a load higher than the rated value. When a higher load is expected, provide an additional system consisting of another interlock switch without lock (such as the HS6B/HS7A interlock switch) or a sensor to detect door opening and stop the machine.
- Regardless of door types, do not use the interlock switch as a door lock. Install a separate lock using a latch or other measures.
- While the solenoid is energized, the switch temperature rises approximately 35°C above the ambient temperature (to approximately 85°C while the ambient temperature is 50°C). Do not touch to prevent burns. If cables come into contact with the switch, use heat-resistant cables.
- Solenoid has polarity. Be sure of correct polarity when wiring, otherwise solenoid will be damaged. Do not apply voltage over the rated voltage, otherwise the solenoid will be burnt.
- Bouncing will occur on the lock monitor contact during locking and unlocking (reference value: 20 ms).

- Do not disassemble or modify the interlock switch, otherwise a malfunction or an accident may occur.
- Do not install the actuator in a location where a human body may come into contact. Otherwise injury may occur.
- Solenoid lock is locked when energized, and unlocked when de-energized. When energization is interrupted due to wire disconnection or other failures, the interlock switch may be unlocked causing possible danger to the operators. Solenoid lock must not be used in applications where locking is strictly required for safety. Perform a risk assessment and determine whether solenoid lock is appropriate.

- Although the HS9Z-A61/A62/A62S actuators alleviate shock when the actuator enters a slot in the interlock switch, make sure that excessive shock is not applied. If the rubber bushings become deformed or cracked, replace with new ones.

**Minimum Radius of Hinged Door**

- When using the interlock switch on hinged doors, refer to the minimum radius of doors shown below. When using on doors with small minimum radius, use the angle adjustable actuator (HS9Z-A65 and HS9Z-A66).

Note: Because deviation or dislocation of hinged doors may occur in actual applications, make sure of the correct operation before installation.

**When Using the HS9Z-A62/A62S Right-angle Actuator**

- When the door hinge is on the extension line of the interlock switch surface:

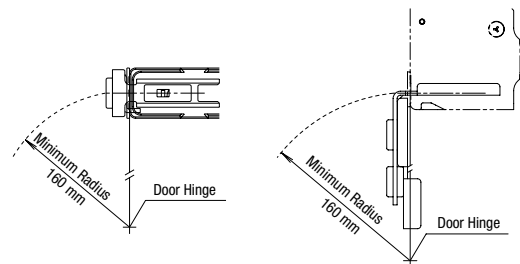

- When the door hinge is on the extension line of the actuator mounting surface:

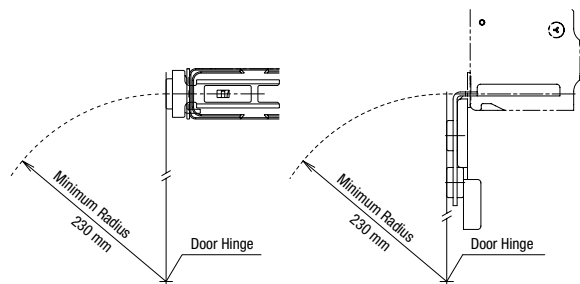



# HS6E Subminiature Interlock Switches with Solenoid

## When using the HS9Z-A65/HS9Z-A66 Angle Adjustable Actuator

- When the door hinge is on the extension line of the interlock switch surface

### Horizontal Adjustment

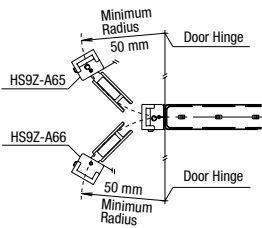

### Vertical Adjustment

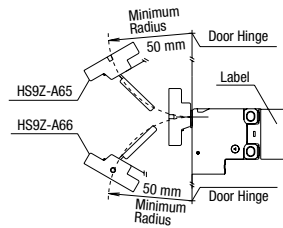

- When the door hinge is on the extension line of the actuator mounting surface

### Horizontal Adjustment

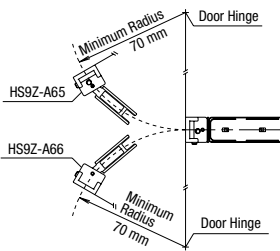

### Vertical Adjustment

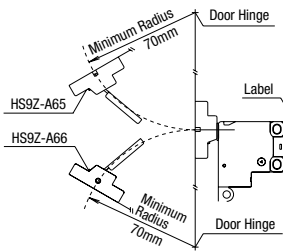

## Actuator Angle Adjustment for the HS9Z-A65/HS9Z-A66

- Using the angle adjustment screw, the actuator angle can be adjusted (see figures on E-070).  
Adjustable angle: 0 to 20°
- The larger the adjusted angle of the actuator, the smaller the applicable radius of the door opening.
- After installing the actuator, open the door. Then adjust the actuator so that its edge can enter properly into the actuator entry slot of the interlock switch.
- After adjusting the actuator angle, apply Loctite to the adjustment screw so that the screw will not become loose.

## Mounting Examples

Mount the interlock switch on a fixated machine or guard, and mount the actuator on the hinged door. Do not mount both interlock switch and actuator on hinged doors, otherwise malfunction will occur.

### Application on Sliding Doors

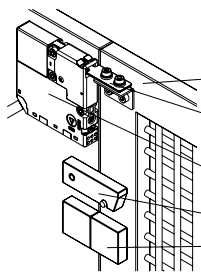

### Application on Hinged Doors

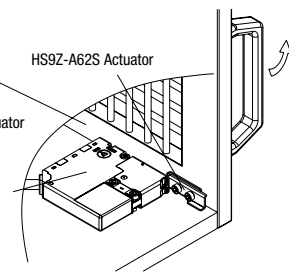

Note: When mounting an actuator, make sure that the actuator enters the slot in the correct direction, as shown on the right.

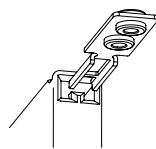

## For Manual Unlocking

### Spring lock

The HS6E allows manual unlocking of the actuator to pre-check proper door operation before wiring or turning power on, as well as for emergency use such as a power failure.

### Solenoid lock

The HS6E can be unlocked manually in emergency.

### When using the manual unlock key

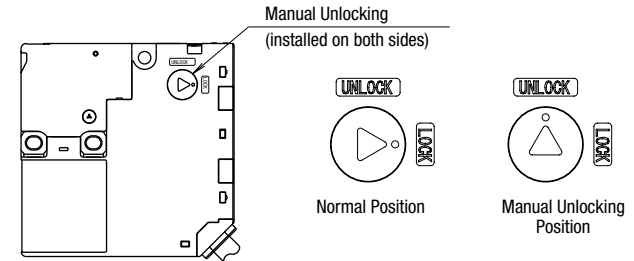

- When locking or unlocking the interlock switch manually, turn the key fully using the manual unlock key supplied with the switch.
- Using the interlock switch with the key not fully turned (less than 90°) may cause damage to the interlock switch or operation failures (when manually unlocked, the switch will keep the main circuit disconnected and the door unlocked).
- Do not apply excessive force (0.45 N·m or more) to the manual unlock part, otherwise the manual unlock part will become damaged.
- Do not leave the manual unlock key attached to the switch during operation. This is dangerous because the switch can always be unlocked while the machine is in operation.



Manual Unlock Key  
(supplied with the interlock switch)

### When unlocking pushing the plate inside the interlock switch

- Remove the screw at the side of the interlock switch (the same side where actuator is inserted) and insert a small screwdriver.
- Push the plate inside the interlock switch toward the LED indicator using the screwdriver until the actuator is unlocked.
- Tighten the screw to a proper torque (0.3 to 0.5 N·m). Do not tighten with excessive force, otherwise the interlock switch will be damaged. Be sure to reinstall the screw, otherwise the waterproof capability will be lost.

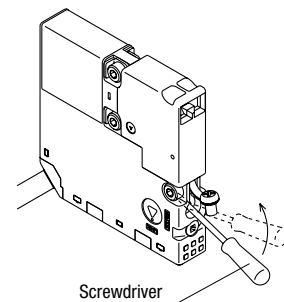

### Caution

Before manually unlocking the interlock switch, make sure that the machine has come to a complete stop. Manual unlocking during operation may unlock the interlock switch before the machine stops, and the function of the interlock switch with solenoid is lost. While the solenoid is energized, do not unlock the switch manually (solenoid lock).

- APEM
- Switches & Pilot Lights
- Control Boxes
- Emergency Stop Switches
- Enabling Switches
- Safety Products
- Explosion Proof
- Terminal Blocks
- Relays & Sockets
- Circuit Protectors
- Power Supplies
- LED Illumination
- Controllers
- Operator Interfaces
- Sensors
- AUTO-ID

- Interlock Switches
- Non-contact Interlock Switches
- Safety Laser Scanners
- Safety Light Curtains
- Safety Modules

- HS6B
- HS6E
- HS5D
- HS5L
- HS1L

- Actuators for HS1/HS5/HS6
- Actuators/Padlock Hasp

### Recommended Tightening Torque of Mounting Screws

- Interlock switch: 1.0 to 1.5 N-m (three M4 screws)
- Actuators: 1.0 to 1.5 N-m (two M4 screws)
- The above recommended tightening torques of the mounting screws are the values with hex socket head bolts. When other screws are used and tightened to a smaller torque, make sure that the screws do not become loose after mounting.
- Mounting bolts are not supplied with the interlock and must be supplied by the user.
- To avoid unauthorized or unintended removal of the interlock switch and the actuator, it is recommended that the interlock switch and the actuator are installed in an unremovable manner, for example using special screws, rivets, or welding the screws.
- When installing the HS9Z-A62S actuator, use the mounting plate (supplied with the actuator) on the hinged door, and secure the actuator tightly using two M4 screws.
- The mounting plate has orientation.
- Do not lose the mounting plate.

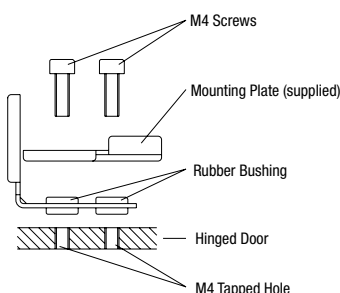

### Cables

- Do not fasten or loosen the gland at the bottom of the interlock switch.
- When bending the cable during wiring, make sure that the cable radius is kept at 30 mm minimum.
- When wiring, make sure that water or oil does not enter from the end of the cable.
- Do not open the lid of the interlock switch. Otherwise the interlock switch will be damaged.
- The solenoid has polarity. Make sure of the correct polarity when wiring.

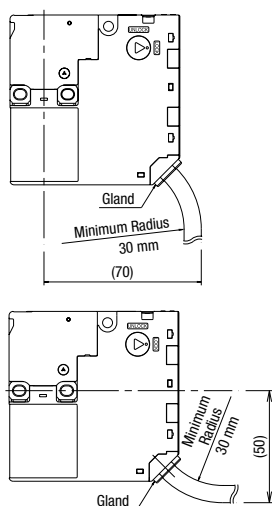

### Wire Identification

- Wires can be identified by the color and or a white line printed on the wire.

No.	Insulation Color	No.	Insulation Color
1	Blue/White	7	White
2	Gray	8	Black
3	Pink	9	Pink/White
4	Orange	10	Brown/White
5	Orange/White	11	Brown
6	Gray/White	12	Blue

Note: Wires of gray or gray/white are not used and should not be connected.

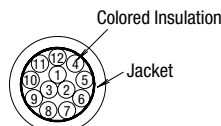

### Terminal Number Identification

- When wiring, identify the terminal number of each contact by the color of insulation.
- The following table shows the identification of terminal numbers.
- When wiring, cut unused wires at the end of the jacket to avoid incorrect wiring.

Model	Contact Arrangement	
	Door Monitor	Lock Monitor
HS6E-L		
HS6E-M	Main circuit: Blue (11) → 12 Monitor circuit: Brown (21) → 22 Monitor circuit: Orange (31) → 32	41 → 42 Blue/White Pink 53 → 54 Pink/White
HS6E-N	Main circuit: Blue (11) → 12 Monitor circuit: Brown (21) → 22 Monitor circuit: Orange (33) → 34	41 → 42 Blue/White Pink 53 → 54 Pink/White
HS6E-P	Main circuit: Blue (11) → 12 Monitor circuit: Brown (21) → 22 Monitor circuit: Orange (33) → 34	41 → 42 Blue/White Pink 51 → 52 Pink/White
HS6E-VL	Monitor circuit: Blue (11) → 12 Monitor circuit: Brown (21) → 22 Monitor circuit: Orange (31) → 32	Gray 41 → 42 Gray/White Pink 53 → 54 Pink/White
HS6E-VM	Monitor circuit: Blue (11) → 12 Monitor circuit: Brown (21) → 22 Monitor circuit: Orange (31) → 32	Gray 41 → 42 Gray/White Pink 51 → 52 Pink/White
HS6E-VN	Monitor circuit: Blue (11) → 12 Monitor circuit: Brown (21) → 22 Monitor circuit: Orange (33) → 34	Gray 41 → 42 Gray/White Pink 53 → 54 Pink/White
HS6E-VP	Monitor circuit: Blue (11) → 12 Monitor circuit: Brown (21) → 22 Monitor circuit: Orange (33) → 34	Gray 41 → 42 Gray/White Pink 51 → 52 Pink/White

Note: The contact arrangements show the contact status when the actuator is inserted and locked.

- APEM
- Switches & Pilot Lights
- Control Boxes
- Emergency Stop Switches
- Enabling Switches
- Safety Products
- Explosion Proof
- Terminal Blocks
- Relays & Sockets
- Circuit Protectors
- Power Supplies
- LED Illumination
- Controllers
- Operator Interfaces
- Sensors
- AUTO-ID
- Interlock Switches
- Non-contact Interlock Switches
- Safety Laser Scanners
- Safety Light Curtains
- Safety Modules
- HS6B
- HS6E
- HS5D
- HS5L
- HS1L
- Actuators for HS1/HS5/HS6
- Actuators/ Padlock Hasp

# Ordering Terms and Conditions

Thank you for using IDEC Products.

By purchasing products listed in our catalogs, datasheets, and the like (hereinafter referred to as "Catalogs") you agree to be bound by these terms and conditions. Please read and agree to the terms and conditions before placing your order.

## 1. Notes on contents of Catalogs

- (1) Rated values, performance values, and specification values of IDEC products listed in this Catalog are values acquired under respective conditions in independent testing, and do not guarantee values gained in combined conditions.  
Also, durability varies depending on the usage environment and usage conditions.
- (2) Reference data and reference values listed in Catalogs are for reference purposes only, and do not guarantee that the product will always operate appropriately in that range.
- (3) The specifications / appearance and accessories of IDEC products listed in Catalogs are subject to change or termination of sales without notice, for improvement or other reasons.
- (4) The content of Catalogs is subject to change without notice.

## 2. Note on applications

- (1) If using IDEC products in combination with other products, confirm the applicable laws / regulations and standards.  
Also, confirm that IDEC products are compatible with your systems, machines, devices, and the like by using under the actual conditions. IDEC shall bear no liability whatsoever regarding the compatibility with IDEC products.
- (2) The usage examples and application examples listed in Catalogs are for reference purposes only. Therefore, when introducing a product, confirm the performance and safety of the instruments, devices, and the like before use. Furthermore, regarding these examples, IDEC does not grant license to use IDEC products to you, and IDEC offers no warranties regarding the ownership of intellectual property rights or non-infringement upon the intellectual property rights of third parties.
- (3) When using IDEC products, be cautious when implementing the following.
  - i. Use of IDEC products with sufficient allowance for rating and performance
  - ii. Safety design, including redundant design and malfunction prevention design that prevents other danger and damage even in the event that an IDEC product fails
  - iii. Wiring and installation that ensures the IDEC product used in your system, machine, device, or the like can perform and function according to its specifications
- (4) Continuing to use an IDEC product even after the performance has deteriorated can result in abnormal heat, smoke, fires, and the like due to insulation deterioration or the like. Perform periodic maintenance for IDEC products and the systems, machines, devices, and the like in which they are used.
- (5) IDEC products are developed and manufactured as general-purpose products for general industrial products. They are not intended for use in the following applications, and in the event that you use an IDEC product for these applications, unless otherwise agreed upon between you and IDEC, IDEC shall provide no guarantees whatsoever regarding IDEC products.
  - i. Use in applications that require a high degree of safety, including nuclear power control equipment, transportation equipment (railroads / airplanes / ships / vehicles / vehicle instruments, etc.), equipment for use in outer space, elevating equipment, medical instruments, safety devices, or any other equipment, instruments, or the like that could endanger life or human health
  - ii. Use in applications that require a high degree of reliability, such as provision systems for gas / waterworks / electricity, etc., systems that operate continuously for 24 hours, and settlement systems
  - iii. Use in applications where the product may be handled or used deviating from the specifications or conditions / environment listed in the Catalogs, such as equipment used outdoors or applications in environments subject to chemical pollution or electromagnetic interference  
If you would like to use IDEC products in the above applications, be sure to consult with an IDEC sales representative.

## 3. Inspections

We ask that you implement inspections for IDEC products you purchase without delay, as well as thoroughly keep in mind management/maintenance regarding handling of the product before and during the inspection.

## 4. Warranty

- (1) Warranty period  
The warranty period for IDEC products shall be one (1) year after purchase or delivery to the specified location. However, this shall not apply in cases where there is a different specification in the Catalogs or there is another agreement in place between you and IDEC.
- (2) Warranty scope  
Should a failure occur in an IDEC product during the above warranty period for reasons attributable to IDEC, then IDEC shall replace or repair that product, free of charge, at the purchase location / delivery location of the product, or an IDEC service base. However, failures caused by the following reasons shall be deemed outside the scope of this warranty.
  - i. The product was handled or used deviating from the conditions / environment listed in the Catalogs
  - ii. The failure was caused by reasons other than an IDEC product
  - iii. Modification or repair was performed by a party other than IDEC
  - iv. The failure was caused by a software program of a party other than IDEC
  - v. The product was used outside of its original purpose
  - vi. Replacement of maintenance parts, installation of accessories, or the like was not performed properly in accordance with the user's manual and Catalogs
  - vii. The failure could not have been predicted with the scientific and technical standards at the time when the product was shipped from IDEC
  - viii. The failure was due to other causes not attributable to IDEC (including cases of force majeure such as natural disasters and other disasters)Furthermore, the warranty described here refers to a warranty on the IDEC product as a unit, and damages induced by the failure of an IDEC product are excluded from this warranty.

## 5. Limitation of liability

The warranty listed in this Agreement is the full and complete warranty for IDEC products, and IDEC shall bear no liability whatsoever regarding special damages, indirect damages, incidental damages, or passive damages that occurred due to an IDEC product.

## 6. Service scope

The prices of IDEC products do not include the cost of services, such as dispatching technicians. Therefore, separate fees are required in the following cases.

- (1) Instructions for installation / adjustment and accompaniment at test operation (including creating application software and testing operation, etc.)
- (2) Maintenance inspections, adjustments, and repairs
- (3) Technical instructions and technical training
- (4) Product tests or inspections specified by you

The above content assumes transactions and usage within your region. Please consult with an IDEC sales representative regarding transactions and usage outside of your region. Also, IDEC provides no guarantees whatsoever regarding IDEC products sold outside your region.

# IDEC CORPORATION

**Head Office** 6-64, Nishi-Miyahara-2-Chome, Yodogawa-ku, Osaka 532-0004, Japan

 [www.idec.com](http://www.idec.com)

**USA** IDEC Corporation  
**EMEA** APEM SAS

**Singapore** IDEC Izumi Asia Pte. Ltd.  
**Thailand** IDEC Asia (Thailand) Co., Ltd.  
**India** IDEC Controls India Private Ltd.

**China** IDEC (Shanghai) Corporation  
IDEC Izumi (H.K.) Co., Ltd.  
**Taiwan** IDEC Taiwan Corporation

**Japan** IDEC Corporation

Specifications and other descriptions in this brochure are subject to change without notice.

2022 IDEC Corporation, All Rights Reserved.

