

## Clamps · DIN 6315 B forked

### 23150.0034

#### Product Description

This clamp (clamping claw) according to DIN 6314 B is forked and is mainly used in mechanical clamping technology for clamping workpieces.

#### Material

- Heat-treated steel, varnished



#### Drawing

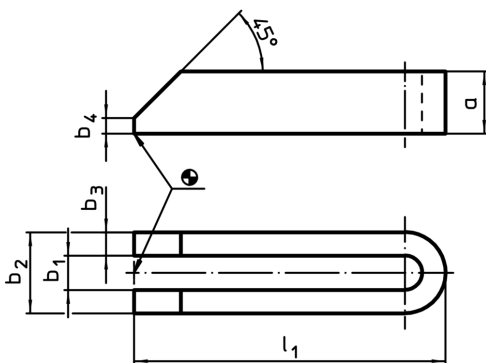

#### Order information

Nominal dimension b <sub>1</sub> [mm]	Dimensions					For screws		[g]	Art. No.
	l <sub>1</sub>	a	b <sub>2</sub> [mm]	b <sub>3</sub>	b <sub>4</sub>	[mm]	[inch]		
33	250	50	74	20	12	M30	1 1/4	3720	23150.0034

#### Compliance

##### RoHS compliant

Compliant according to Directive 2011/65/EU and Directive 2015/863

##### Does not contain SVHC substances

No SVHC substances with more than 0.1% w/w contained - SVHC list [REACH] as of 10.06.2022

##### Does not contain Proposition 65 substances

No Proposition 65 substances included

<https://www.P65Warnings.ca.gov/>

##### Free from Conflict Minerals

This product does not contain any substances designated as "conflict minerals" such as tantalum, tin, gold or tungsten from the Democratic Republic of Congo or adjacent countries.