

# BOLERO

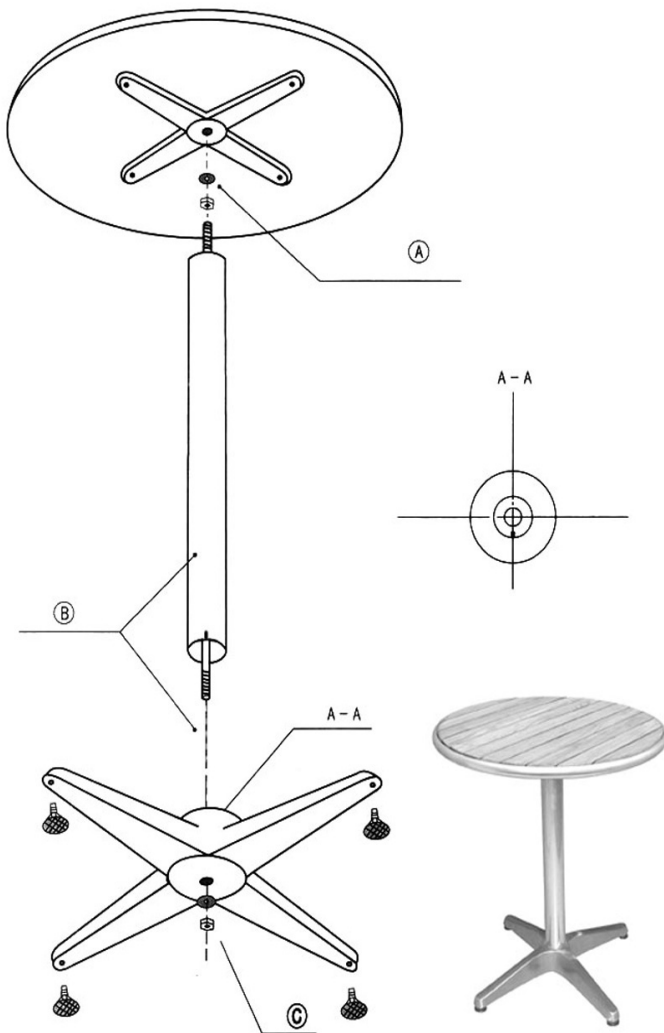







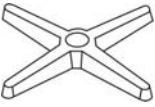

- Ⓚ **Telephone Helpline:** 0845 146 2887 (United Kingdom) / 1300 225960 (Australia)
- Ⓝ **Klantenondersteuning:** 040 – 2628080 (Nederland) / 050 – 609999 (België)
- Ⓧ **Standard d'assistance téléphonique:** 01 64 89 73 61 (Français) / 050 – 600006 (Belgique)
- Ⓝ **Telefonische Helpline:** 0800 – 1860806 (Deutschland)
- Ⓧ **Línea de asistencia telefónica :** 901-100 133 (España)

## Code U428/U429:- Ash Bistro Table

### Assembly Instructions:-



### Parts list:

	1 x Table Top
	1 x Aluminium Foot Base WITH:
	1 x Base weight
	2 x Flat Washer
	2 x Hexagonal Nut
	4 x Screw Foot Caps
	1 x Rod
	1 x Aluminium tube
	1 x Spanner
	1 x Hexagonal Nut Tightening Tool
	2 x Spring washers

## **Assembly instructions:**

1. Thread a hexagonal nut onto one threaded end of the rod with a spring washer to follow.
2. Place a flat washer over the hole on the metal spider on the underside of the table, and insert the threaded end of the rod
3. Turn the threaded rod until it securely grips into the metal spider on the underside of the table (do not tighten so much that the bar presses against the underside of the table itself)
4. Tighten the nut back down onto the unit using the spanner supplied
5. Place the aluminium tube over the threaded rod, ensuring that the end of the tube is securely positioned on the metal spider (see detail A)
6. Place the aluminium foot base over the end of the threaded rod (see detail B), ensuring the notch at the bottom of the tube lines up with the lug on the table base (as shown in detail A-A)
7. Place a flat washer, a spring washer and hexagonal nut on the end of the threaded bar (see detail C) and tighten using the socket spanner
8. Finally screw the feet caps to the underside of the Table foot base

## **Maintenance:**

Wood is a natural material whose appearance will deteriorate when left outside. A surface coating is vital in protecting it from premature darkening or splitting, when exposed to the weather. The finish should be regularly maintained to ensure that the wood is protected from moisture and the furniture continues to look its best.

In order to maintain the appearance of the wood, regular coatings of teak oil should be applied in accordance with the instructions supplied with the oil. The frequency will depend on the weather conditions experienced.

If positioned in an exposed position, we recommend the use of a parasol to prevent oils from drying out and flaking. This will help maintain the appearance of the table surface.

In order to maintain its appearance, this wooden furniture should be protected from severe weather and stored under cover during winter. A liberal coating of Oil should be given to the furniture before it is laid up and again when it is removed from storage.

Should you choose not to treat your furniture then it will turn a greyish colour and develop cracks. Light sanding can restore the original colour after which teak Oil can be regularly applied in accordance with the instructions above.