

## Flush-type connector - SACC-CI-M12MS-5P SMD T - 1411926

Please be informed that the data shown in this PDF Document is generated from our Online Catalog. Please find the complete data in the user's documentation. Our General Terms of Use for Downloads are valid (<http://phoenixcontact.com/download>)



Flush-type connector, 5-position, PlugLink:straightLink:M12, A - standard, PCB mounting, SMD

### Why buy this product

- Reduced mounting costs thanks to two-piece device connector
- Packaging available for automated pick and place assembly
- All common pin assignments and codings available
- Easy device integration thanks to mechanical port screw connections with threaded attachment, press-in contour or direct integration in the front plate
- Optional shield connection and seal for the device when not plugged in

### Key Commercial Data

Packing unit	60 STK
Minimum order quantity	60 STK
GTIN	
GTIN	4046356990042
Weight per Piece (excluding packing)	4.040 g
Custom tariff number	85366990
Country of origin	Germany
Note	Made to Order (non-returnable)

### Technical data

#### Ambient conditions

Ambient temperature (operation)	-55 °C ... 105 °C (Plug / socket)
	-55 °C ... 105 °C (without mechanical actuation)
Degree of protection	IP67 (correctly plugged in and locked)

#### General

Note	The electrical and mechanical data specified assume that the connector pair is correctly locked and mounted. If the connector is unlocked and if
------	--

# Flush-type connector - SACC-CI-M12MS-5P SMD T - 1411926

## Technical data

### General

	there is a danger of contamination, the connector must be sealed using a protective cap > IP54. Influences arising from litz wires, cables or PCB assembly must also be taken into consideration.
Rated current at 40°C	4 A
Rated voltage	60 V
Rated surge voltage	1.5 kV
Number of positions	5
Insulation resistance	≥ 100 MΩ
Coding	A - standard
Standards/regulations	M12 connector IEC 61076-2-101 In line with
Overvoltage category	III
Degree of pollution	3
Connection method	SMD
Insertion/withdrawal cycles	> 100
Mounting type	PCB mounting
Type of packaging	Tray
Delivery state	with assembly pad

### Material

Flammability rating according to UL 94	V0
Contact material	CuZn
Contact surface material	Au
Contact carrier material	PA

### Cable

Standards/specifications	M12 connector IEC 61076-2-101 In line with
--------------------------	--

### Standards and Regulations

Standard designation	M12 connector
Standards/regulations	IEC 61076-2-101
Flammability rating according to UL 94	V0

### Environmental Product Compliance

China RoHS	Environmentally Friendly Use Period = 50
	For details about hazardous substances go to tab "Downloads", Category "Manufacturer's declaration"

## Drawings

# Flush-type connector - SACC-CI-M12MS-5P SMD T - 1411926

Schematic diagram

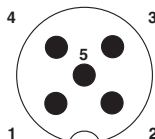

Pin assignment M12 male connector, 5-pos., A-coded, male side

Drilling diagram

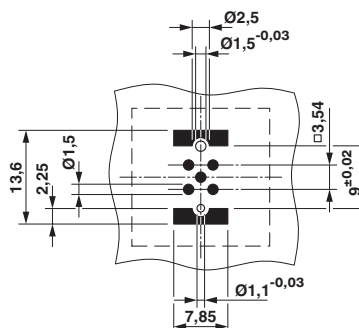

Soldering pad geometry

Dimensional drawing

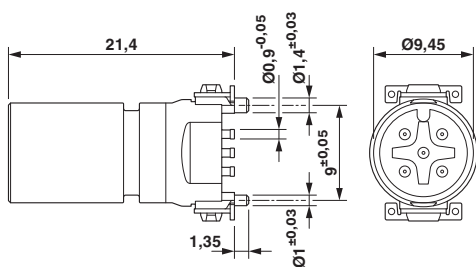

Dimensional drawing

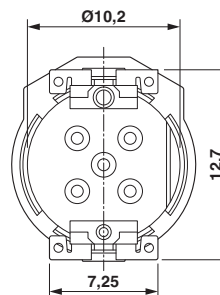

M12 male connector contact carrier

View of solder side

Dimensional drawing

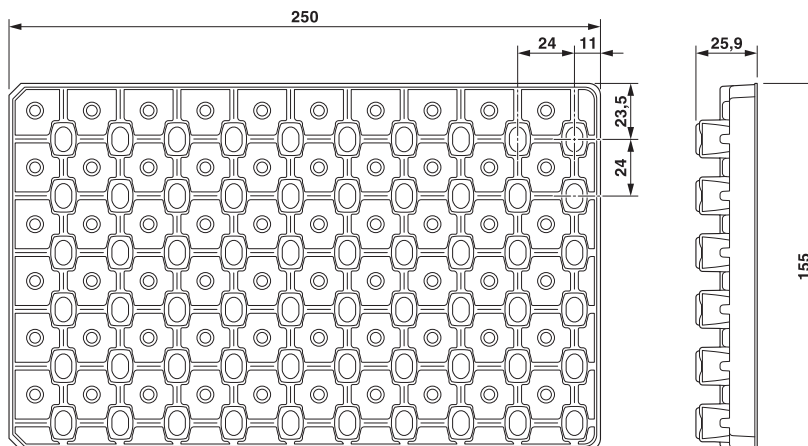

SMD tray packaging

# Flush-type connector - SACC-CI-M12MS-5P SMD T - 1411926

## Classifications

### eCl@ss

eCl@ss 5.1	27143423
eCl@ss 6.0	27143423
eCl@ss 8.0	27440103
eCl@ss 9.0	27440102

### ETIM

ETIM 5.0	EC002061
ETIM 6.0	EC002061

### UNSPSC

UNSPSC 13.2	39121413
-------------	----------

## Approvals

### Approvals

#### Approvals

EAC / cULus Recognized

#### Ex Approvals

### Approval details

EAC		B.01742
-----	---	---------

cULus Recognized		<a href="http://database.ul.com/cgi-bin/XYV/template/LISEXT/1FRAME/index.htm">http://database.ul.com/cgi-bin/XYV/template/LISEXT/1FRAME/index.htm</a> E221474-20160506
Nominal current IN	4 A	
Nominal voltage UN	60 V	

## Accessories

### Accessories

Panel mounting base

## Flush-type connector - SACC-CI-M12MS-5P SMD T - 1411926

### Accessories

Housing screw connection - SACC-BP-M-M12/M15-6-SMD - 1414000



Housing screw connection, PlugLink:M12, Rear mounting, M15 x 1

---

Housing screw connection - SACC-BP-M-M12/M15-6-SMD SCO - 1414002



Housing screw connection, PlugLink:M12-SPEEDCON, Rear mounting, M15 x 1

---

Housing screw connection - SACC-FP-M-M12/M14 SMD - 1412078



Housing screw connection, PlugLink:M12, Front mounting, M14 x 1

---

Housing screw connection - SACC-FP-M-M12/PRESS SMD - 1412080



Housing screw connection, pin, for the two-part M12 SMD connector, for press-in mounting.

---