

M12 female 0° with cable DeviceNet

PUR AWG24+AWG22 shielded vt UL/CSA+drag ch. 18m

M12

Female straight

DeviceNet, CANopen

5-pole, shielded

Plastic housings with good resistance against chemicals and oils. The resistance to aggressive media should be individually tested for your application. Further details on request. Further cable lengths on request.

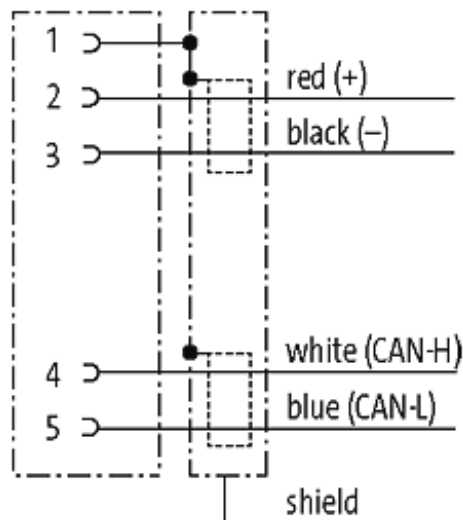
[Link to Product](#)**Illustration**

Female



Product may differ from Image

Approvals



More Info



Form

13225

Technical Data

Operating voltage	max. 60 V AC/DC
Operating current per contact	max. 4 A
Locking of ports	Screw thread M12 × 1 mm (recommended torque 0.6 Nm) self-securing
Protection	IP67 inserted and tightened (EN 60529)

Cables

Cable number	803
--------------	-----

No./diameter of wires	2×0.25 + 2×0.34 mm ²
Wire isolation	PE (rd, bk), (bl, wh)
C-track properties	5 Mio.
Jacket Color	violet
Shore hardness outer jacket	90 ± 5A
Material (jacket)	PUR (UL/CSA)
Outer diameter	approx. 6.9 mm
Bend radius (fixed)	8 × outer Ø
Bend radius (moving)	12 × outer Ø
Temperature range (fixed)	-40...+80 °C
Temperature range (mobile)	-20...+60 °C
Shielded	yes

Commercial data

country of origin	CZ
customs tariff number	85444290
minimum order quantity	1