

High Current Through-Hole Inductor, High Temperature Series

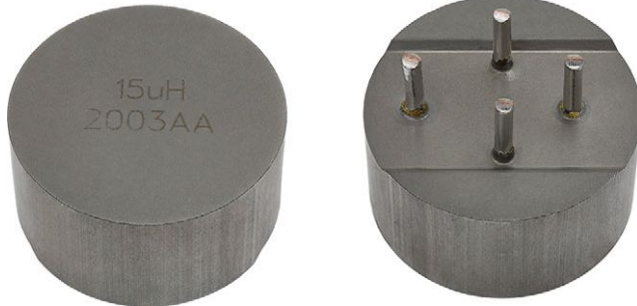

FEATURES

- Shielded construction
- High temperature, up to 155 °C
- Excellent DC/DC energy storage up to 2 MHz
- Filter inductor applications up to SRF (see “Standard Electrical Specifications” table)
- Handles high transient current spikes without saturation
- Ultra low buzz noise, due to composite construction
- Material categorization: for definitions of compliance please see www.vishay.com/doc?99912

AUTOMOTIVE GRADE



RoHS COMPLIANT

HALOGEN FREE

GREEN (5-2008)

STANDARD ELECTRICAL SPECIFICATIONS						
L ₀ INDUCTANCE ± 20 % AT 100 kHz, 0.25 V, 0 A (μH)	DCR TYP. 25 °C (mΩ)	DCR MAX. 25 °C (mΩ)	HEAT RATING CURRENT DC TYP. (A) ⁽¹⁾	SATURATION CURRENT DC TYP. (A)		SRF TYP. (MHz)
				(2)	(3)	
6.8	1.1	1.2	63.3	75.5	106.2	8.3
10	1.6	1.7	52.9	59.6	85.2	5.7
22	3.7	3.9	34.4	44.8	59.78	3.5
33	4.9	5.1	28.7	39.9	56.6	2.6
47	8.9	9.3	20.5	32.1	45.3	1.9
100	21.5	22.6	12.2	23.2	33.7	1.2

Notes

- All test data is referenced to 25 °C ambient
- Operating temperature range -55 °C to +155 °C
- The part temperature (ambient + temp. rise) should not exceed 155 °C under worst case operating conditions. Circuit design, component placement, PWB trace size and thickness, airflow and other cooling provisions all affect the part temperature. Part temperature should be verified in the end application
- (1) DC current (A) that will cause an approximate ΔT of 40 °C
- (2) DC current (A) that will cause L₀ to drop approximately 20 %
- (3) DC current (A) that will cause L₀ to drop approximately 30 %

APPLICATIONS

- 48 V to 12 V input / output filters
- Diesel injection drivers
- Noise suppression for motors

DIMENSIONS in inches

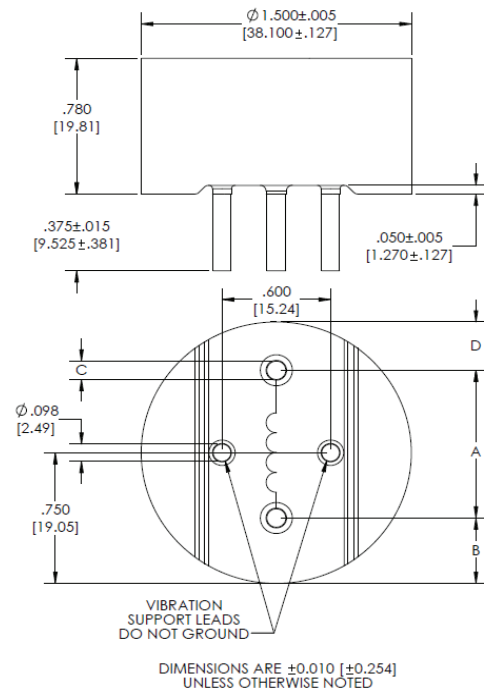

VALUE	A	B	C	D
6.8 μH	0.865 [21.97]	0.367 [9.32]	0.113 [2.87]	0.268 [6.81]
10 μH	0.844 [21.44]	0.377 [9.58]	0.113 [2.87]	0.279 [7.09]
22 μH	0.981 [24.92]	0.302 [7.67]	0.09 [2.29]	0.217 [5.51]
33 μH	0.981 [24.92]	0.302 [7.67]	0.09 [2.29]	0.217 [5.51]
47 μH	1.014 [25.76]	0.277 [7.04]	0.073 [1.85]	0.209 [5.31]
100 μH	1.041 [26.44]	0.257 [6.53]	0.058 [1.47]	0.202 [5.13]



DESCRIPTION		
IHTH-1500TZ-5A MODEL	6.8 μ H INDUCTANCE VALUE	$\pm 20\%$ INDUCTANCE TOLERANCE

GLOBAL PART NUMBER																	
I	H	T	H	1	5	0	0	T	Z	E	B	6	R	8	M	5	A
MODEL				SIZE				PACKAGE CODE		INDUCTANCE VALUE			INDUCT. TOL.		SERIES		

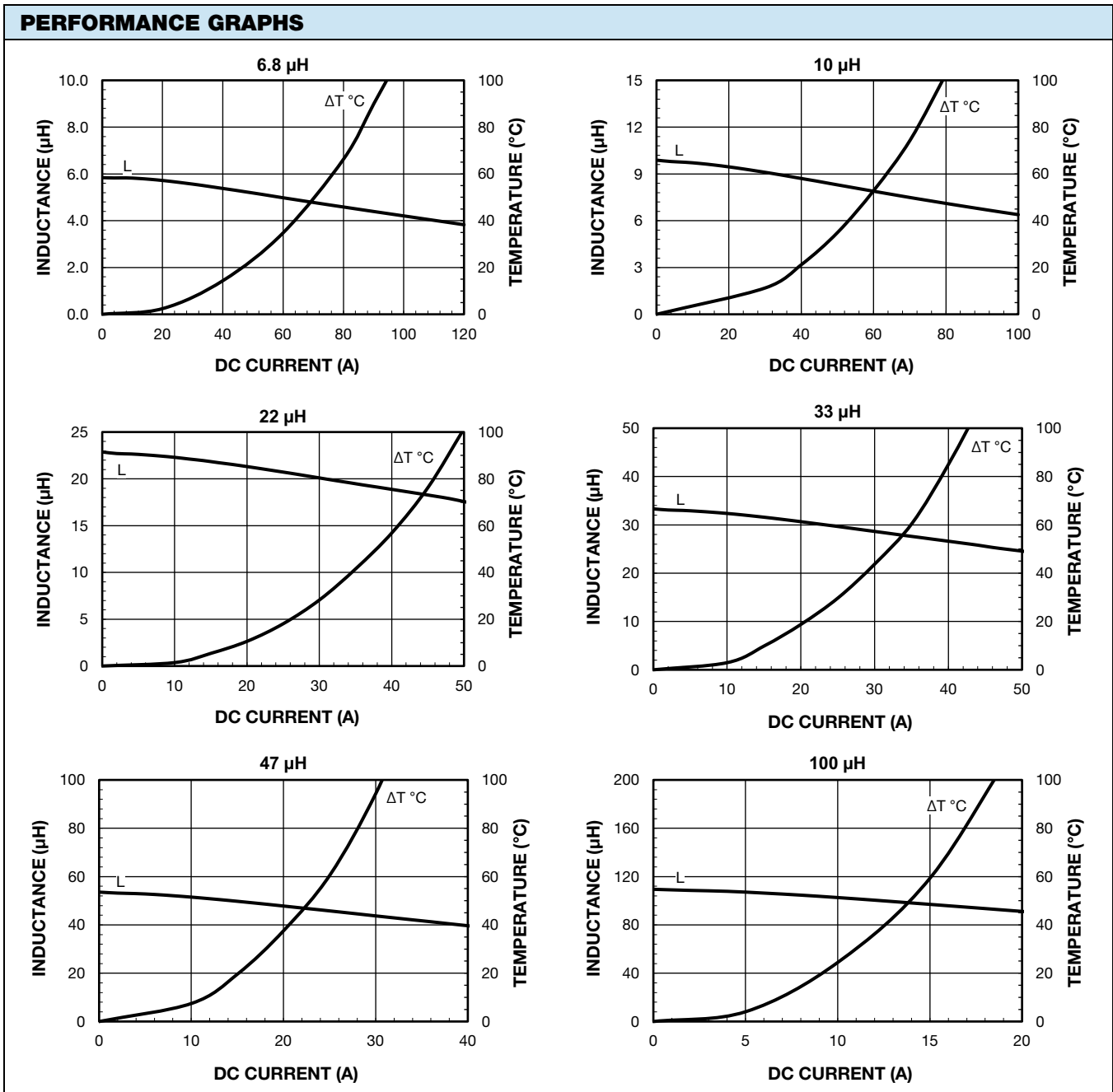



PERFORMANCE GRAPHS: INDUCTANCE AND Q VS. FREQUENCY

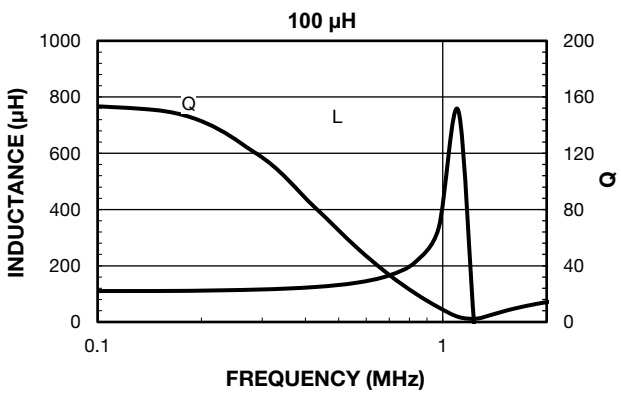
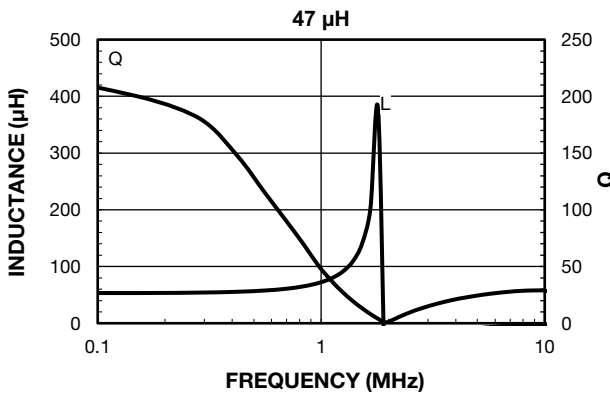
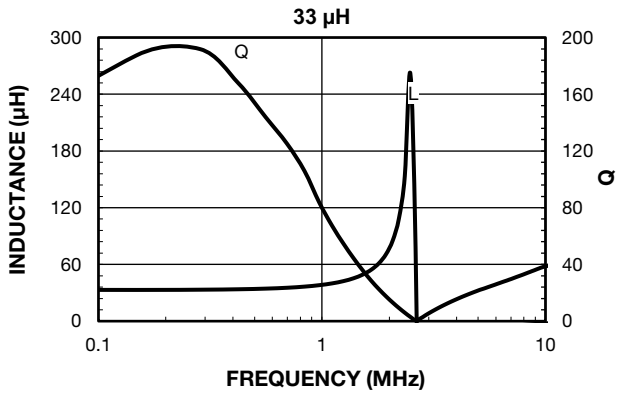
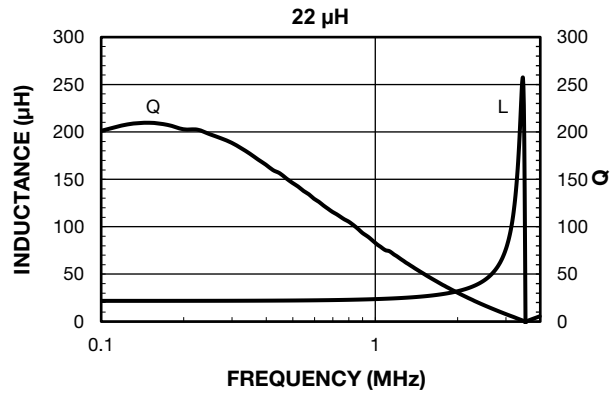
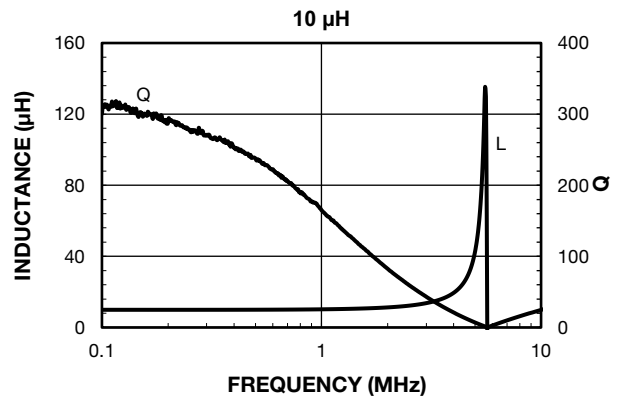
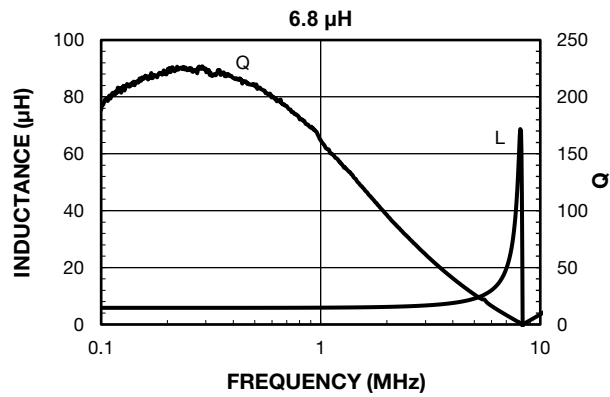



Disclaimer

ALL PRODUCT, PRODUCT SPECIFICATIONS AND DATA ARE SUBJECT TO CHANGE WITHOUT NOTICE TO IMPROVE RELIABILITY, FUNCTION OR DESIGN OR OTHERWISE.

Vishay Intertechnology, Inc., its affiliates, agents, and employees, and all persons acting on its or their behalf (collectively, "Vishay"), disclaim any and all liability for any errors, inaccuracies or incompleteness contained in any datasheet or in any other disclosure relating to any product.

Vishay makes no warranty, representation or guarantee regarding the suitability of the products for any particular purpose or the continuing production of any product. To the maximum extent permitted by applicable law, Vishay disclaims (i) any and all liability arising out of the application or use of any product, (ii) any and all liability, including without limitation special, consequential or incidental damages, and (iii) any and all implied warranties, including warranties of fitness for particular purpose, non-infringement and merchantability.

Statements regarding the suitability of products for certain types of applications are based on Vishay's knowledge of typical requirements that are often placed on Vishay products in generic applications. Such statements are not binding statements about the suitability of products for a particular application. It is the customer's responsibility to validate that a particular product with the properties described in the product specification is suitable for use in a particular application. Parameters provided in datasheets and / or specifications may vary in different applications and performance may vary over time. All operating parameters, including typical parameters, must be validated for each customer application by the customer's technical experts. Product specifications do not expand or otherwise modify Vishay's terms and conditions of purchase, including but not limited to the warranty expressed therein.

Hyperlinks included in this datasheet may direct users to third-party websites. These links are provided as a convenience and for informational purposes only. Inclusion of these hyperlinks does not constitute an endorsement or an approval by Vishay of any of the products, services or opinions of the corporation, organization or individual associated with the third-party website. Vishay disclaims any and all liability and bears no responsibility for the accuracy, legality or content of the third-party website or for that of subsequent links.

Except as expressly indicated in writing, Vishay products are not designed for use in medical, life-saving, or life-sustaining applications or for any other application in which the failure of the Vishay product could result in personal injury or death. Customers using or selling Vishay products not expressly indicated for use in such applications do so at their own risk. Please contact authorized Vishay personnel to obtain written terms and conditions regarding products designed for such applications.

No license, express or implied, by estoppel or otherwise, to any intellectual property rights is granted by this document or by any conduct of Vishay. Product names and markings noted herein may be trademarks of their respective owners.