

THE ENTRY MODEL TO SATISFY HIGH STANDARDS

P10

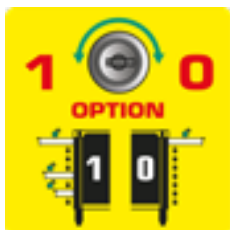

Workshop trolley P10
with 8 compartments
873.0008



DUO Lock Brilliant locking system



Eight drawers each load capacity up to 50 kg



Stable **ball bearing**



Stainless steel surface

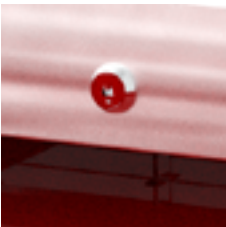

Lock lockable



Anti-static castors with brakes



Integrated **corner protection**



Paper roll holder included



Can holder included

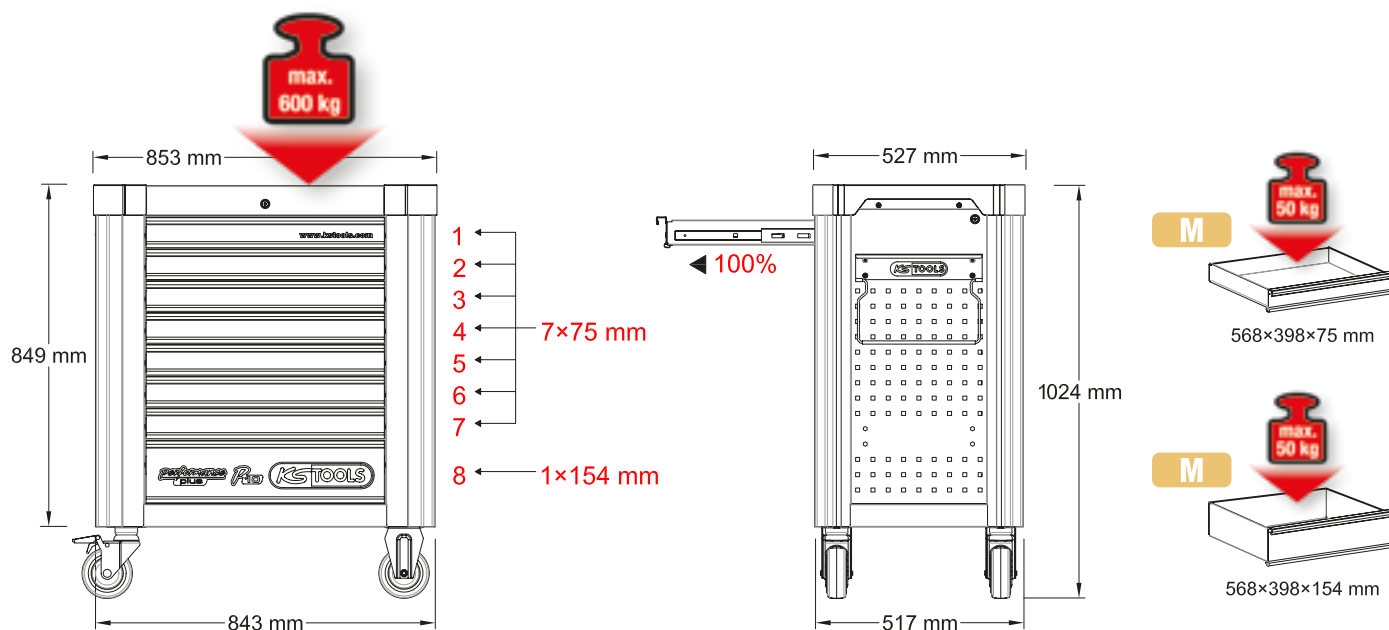

P10

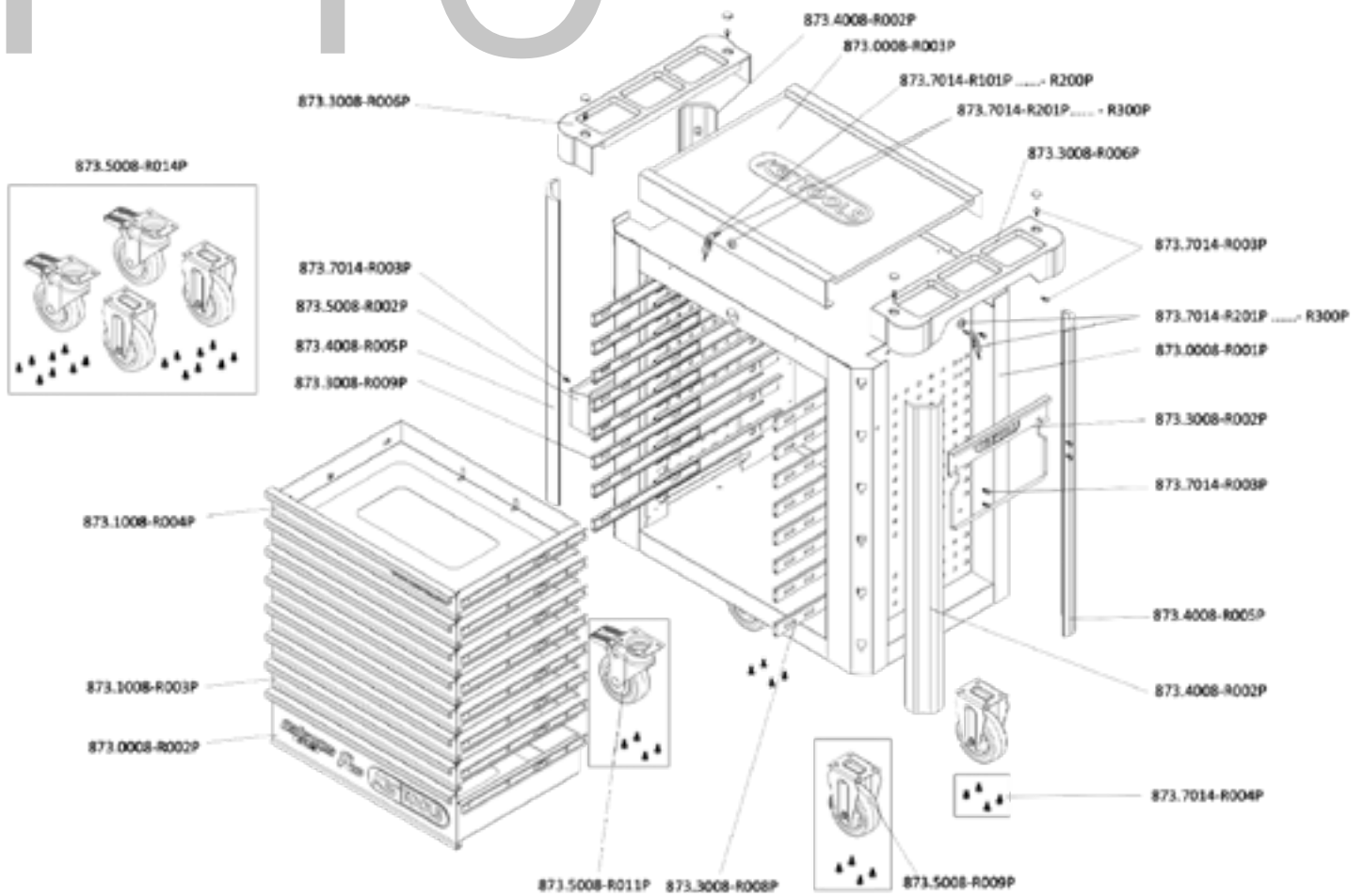

INDIVIDUAL PARTS LIST

Item No.	Description	Amount
873.7014-R101P...	Replacement key for PERFORMANCEplus workshop trolley lock number xyz	2
873.7014-R201P...	Lock with 2 keys for PERFORMANCEplus workshop trolley lock number xyz	2
873.0008-R001P	Body with handle	1
873.0008-R002P	Compartment with logo and ball-bearing guide, 568x398x145 mm	1
873.0008-R003P	Stainless steel worktop	1
873.1008-R003P	Compartment with ball-bearing guide, for workshop trolley P10/P10TC/P15, 568x398x65 mm	6
873.1008-R004P	Compartment with website and ball-bearing guide, for workshop trolley P10/P15, 568x398x65 mm	1
873.3008-R002P	Paper roll holder for PERFORMANCEplus workshop trolley	1
873.3008-R006P	Storage for work surface	2
873.3008-R008P	Full extension (with ball-bearing guide) with automatic retraction	8
873.3008-R009P	Full extension (with ball-bearing guide) with automatic retraction	8
873.4008-R002P	Plastic bumpers	2
873.4008-R005P	Plastic bumpers	2
873.5008-R002P	Can holder for PERFORMANCEplus workshop trolley	1
873.5008-R009P	Fixed castors for PERFORMANCEplus workshop trolley, incl. screws	2
873.5008-R011P	Swivel castors with brakes, for PERFORMANCEplus workshop trolley, incl. screws	2
873.5008-R014P	Roller set for PERFORMANCEplus workshop trolley, incl. screws	1
873.7014-R003P	M6x12 screws for PERFORMANCEplus workshop trolley accessories	14
873.7014-R004P	M8 screws for PERFORMANCEplus workshop trolley rollers (16 pcs.)	1



873.7014-R101P...R200P
Replacement key for lock number xyz



873.7014-R201P...R300P
Lock with 2 keys for lock number xyz



873.3008-R008P
Full extension (with ball-bearing guide) with automatic retraction, right



873.3008-R009P
Full extension (with ball-bearing guide) with automatic retraction, left



873.5008-R009P
Fixed castors, incl. screws



873.5008-R011P
Swivel castors with brakes, incl. screws



873.5008-R014P
Roller set, incl. screws



873.0008-R003P
Stainless steel work surface



873.3008-R006P
Storage for work surface, including screw cover, usable on both sides



873.1008-R004P
Compartment with website and ball-bearing guide, 568x398x65 mm



873.1008-R003P
Compartment with ball-bearing guide, 568x398x65 mm



873.0008-R002P
Compartment with logo and ball-bearing guide, 568x398x145 mm



873.5008-R002P
Can holder, 310 mm



873.3008-R002P
Paper roll holder, 320 mm



873.4008-R005P
Plastic bumpers, front left, back right



873.4008-R002P
Plastic bumpers, front right, back left



873.7014-R004P
M8 screws (16 pcs.)



873.7014-R003P
M6x12 screw (1 pcs.)



873.0008-R001P
Body with handle



A thousand great parts for tough guys!



EACH TROLLEY IS UNIQUE

**Tool holders, pipe holders, storage shelves,
magnetic shells, clamps, holders and hooks:
The extensive range of accessories for
Performance Plus fulfils every wish and turns
your workshop trolley into your personal
one-of-a-kind piece. Extend your performance!**

**FREELY CONFIGURABLE –
EVEN AFTER PURCHASING**

**Fully tailored
to your needs**

**HOLDERS FOR ALL
TYPES OF TOOLS**

ACCESSORIES

- Accessories suitable for hole measurements
10 x 10 mm – hole distance 38 mm
- fixing screws included
- baseplate thickness 1.5 mm
- galvanised steel plate



860.0855
Pipe holder, Ø 60mm



860.0856
Pipe holder, Ø 100mm



860.0857
Storage shelf without partition,
350x125mm



860.0858
Storage shelf without partition,
450x150mm



860.0859
Lin bin holder single, size 7+8



860.0870
Universal tool holder self drill,
390x45mm



860.0871
Universal tool storage box,
55x310x125mm

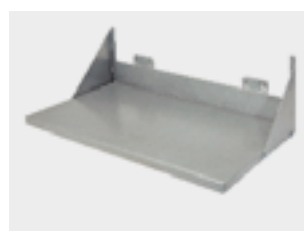

860.0878
Sheet steel tray, 435x250mm



860.0873
Socket holder, 9 holes, 390x30mm

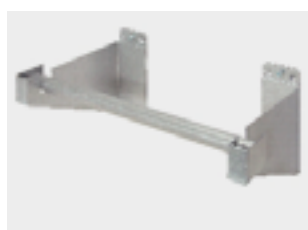

860.0879
Paper roll holder, 355mm



860.0880
Document holder, 220x310mm



860.0881
Works order holder, 220x310mm



860.0886
Drill holder for MK 2 and MK 3
shafts, 16 holes



860.0882
Magnet set, Ø 25mm, red, pack of 10



860.0883
Magnet set, Ø 25mm, green, pack of 10



860.0884
Magnet set, Ø 25mm, blue, pack of 10



860.0887
Bit holder, 7 holes, 150x35mm



860.0872
Hexagon socket holder, 11 holes, 145x70mm



860.0894
Socket holder for 1/2" sockets, 6 holes



860.0895
Socket holder for 1/2" sockets, 13 holes



860.0801
Tool holder with straight end Ø 6mm, 50mm



860.0802
Tool holder with straight end Ø 6mm, 100mm



860.0803
Tool holder with straight end Ø 6mm, 150mm



860.0820
Double tool holder with straight end Ø 6mm, 35mm



860.0821
Double tool holder with straight end Ø 6mm, 50mm



860.0822
Double tool holder with straight end Ø 6mm, 75mm



860.0804
Tool holder with angled hook end Ø 6mm, 50mm



860.0805
Tool holder with angled hook end Ø 6mm, 100mm



860.0806
Tool holder with angled hook end Ø 6mm, 150mm



860.0807
Tool holder with angled hook end Ø 6mm, 200mm



860.0812
Double tool holder with angled hook end, Ø 6 mm, 35mm



860.0813
Double tool holder with angled hook end, Ø 6 mm, 50mm



860.0814
Double tool holder with angled hook end, Ø 6 mm, 75mm



860.0815
Double tool holder with angled hook end, Ø 6 mm, 150mm



860.0809
Tool holder with vertical hook end Ø 6mm, 35mm



860.0810
Tool holder with vertical hook end Ø 6mm, 75mm



860.0811
Tool holder with vertical hook end Ø 6mm, 125mm



860.0816
Double tool holder with vertical hook end, Ø 6 mm, 35mm



860.0817
Double tool holder with vertical hook end, Ø 6 mm, 50mm

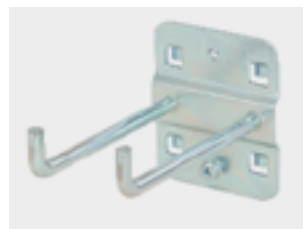

860.0818
Double tool holder with vertical hook end, Ø 6 mm, 75mm

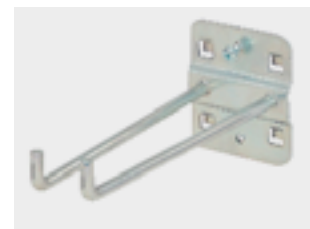

860.0819
Double tool holder with vertical hook end, Ø 6 mm, 150mm



860.0824
Tool clip, single small, Ø 6mm



860.0825
Tool clip, single small, Ø 10mm



860.0826
Tool clip, single small, Ø 13mm



860.0827
Tool clip, single small, Ø 16mm



860.0828
Tool clip, single small, Ø 19mm



860.0829
Tool clip, double small, Ø 6mm



860.0830
Tool clip, double small, Ø 10mm



860.0831
Tool clip, double small, Ø 13mm



860.0832
Tool clip, double small, Ø 16mm



860.0833
Tool clip, double small, Ø 19mm



860.0834
Tool clip, single large, 25mm



860.0835
Tool clip, single large, 28mm

ACCESSORIES



860.0836
Tool clip, single large, 32mm



860.0823
Angled hook for nuts and sockets
Ø 6mm



860.0837
Pliers holder depth 20mm, 35mm



860.0838
Pliers holder depth 20mm, 55mm



860.0839
Pliers holder depth 20mm, 75mm



860.0840
Round holder, 25x65mm



860.0841
Power tool holder, Ø 40mm



860.0842
Power tool holder, Ø 60mm



860.0843
Power tool holder, Ø 80mm



860.0844
Tool holder 3 way, Ø 6mm, 150mm



860.0874
Cable holder, 150mm



860.0875
Cable holder, 200mm



860.0876
Tool holder for euro blister
packaging, 125mm



860.0877
Tool holder for euro blister
packaging, 150mm

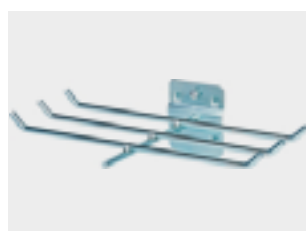

860.0845
Six way tool holder hook ends 45°
angled



860.0860
Base plate, small



860.0861
Base plate, large



860.0862
Lin bin holder, 550x40mm



860.0863
Lin bin holder, 550x60mm



860.0864
Spanner holder tapered for 10 spanners, 145mm



860.0865
Spanner holder tapered for 10 spanners, 225mm



860.0866
Can holder Ø 70mm, 100mm

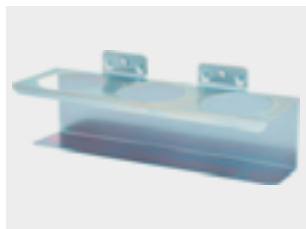

860.0867
Can holder Ø 70mm, 300mm

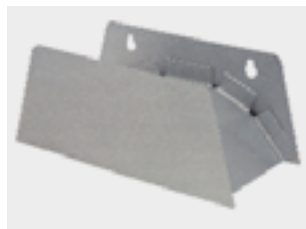

860.0868
Pipe holder 230x70mm

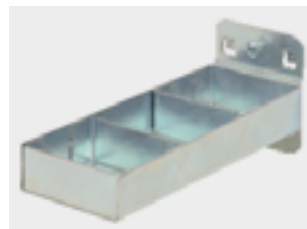

860.0847
Small component tray with partition, 150x55mm



860.0848
Small component tray without partition, 150x55mm



860.0869
Universal tool holder self drill, 120x70mm

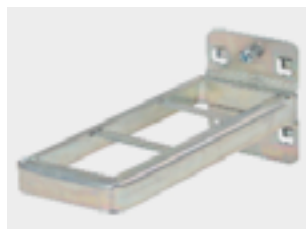

860.0846
Combination holder 150x55mm



860.0849
Spanner holder horizontal, 8 holes



860.0850
Screwdriver holder, 6 holes, 150x55mm



860.0851
Screwdriver holder, 12 holes, 150x55mm



860.0852
Drill- and hexagon socket holder, 14 holes



860.0853
Drill- and hexagon socket holder, 28 holes



860.0854
Saw holder, 4 holes, 150mm

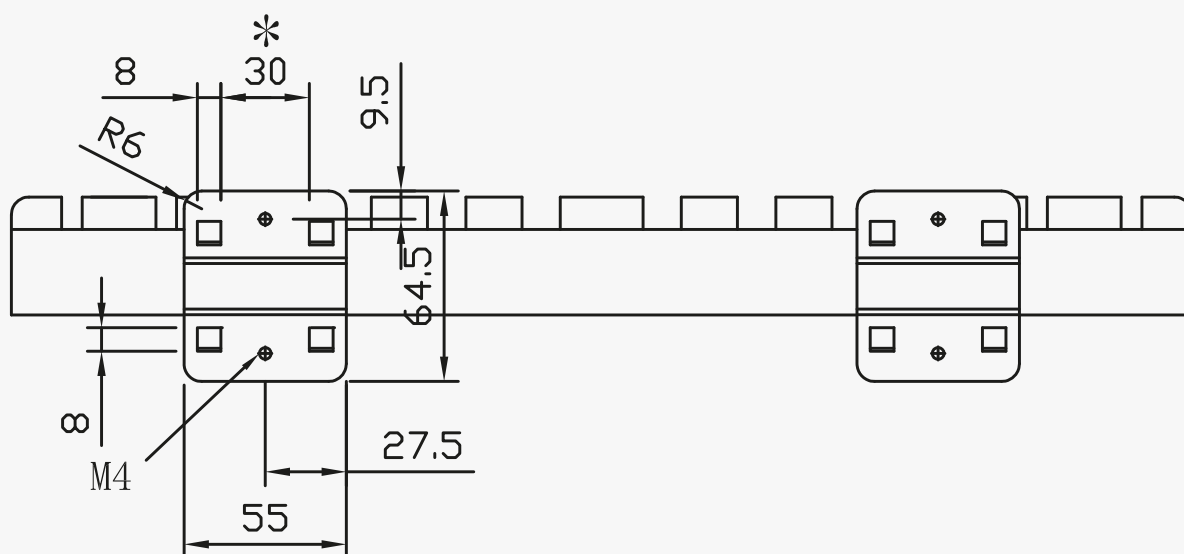

HIDE YOUR TREASURE UNDER THE HOOD

If you work with Performance Plus, you probably aren't interested in knocking off work so quickly. But when the time does come, you can cover your workshop trolley with the matching hood to protect it from dust and scratches.



873.0010
Cover for workshop trolley P10,
890x560x860 mm