

Face milling cutters, 45°

For SEET 12T3... indexable milling inserts

ORION[®]

Application:

For universal use in all materials, predestined for cast processing.

Execution:

- Nickel-plated supports
- Long-term tested support design
- Normal and fine pitch
- Clamping screw tightening torque (indexable insert) M3.5 = 3.9 Nm

Advantage:

- Highly positive indexable milling inserts for low-vibration, steady cutting
- Outstanding value for money

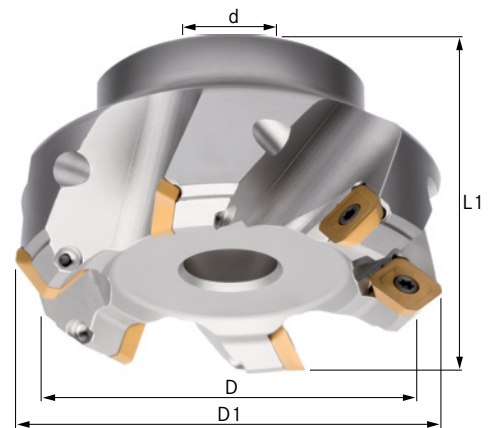

Art. no.	16003 204
Brand	ORION
Manufacturer Part Number	16003204
Min. cutting edge diameter	125 mm
Max. cutting edge diameter	137.5 mm
Length	63 mm
Bore diameter	40 mm
max. ap	6 mm
Number of cutting edges	6 PCS
Gross Weight	4.055 kg
Product Group	148

EAN

4039247532292

