

SW	DETECTION SWITCH
C8	RESERVED
C7	I/O
C6	VPP
C5	GND
C4	RESERVED
C3	CLK
C2	RST
C1	VCC
PIN No.	PIN NAME

SIM CARD PIN ASSIGNMENT

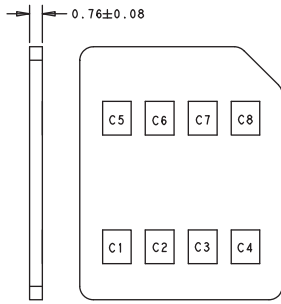

SIM CARD PAD LAYOUT

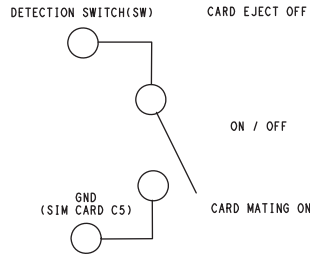

CIRCUIT DRAWING OF SWITCH

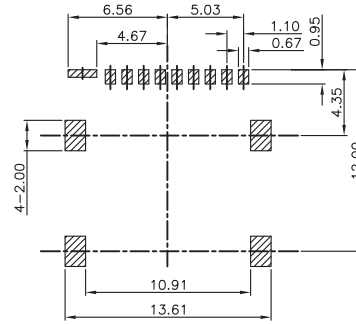

PCB LAYOUT - COMPONENT VIEW

TECHNICAL CHARACTERISTICS

MATERIAL  
 INSULATOR: LCP  
 FLAMABILITY RATING: UL94-V0  
 COLOR: BLACK  
 CONTACT MATERIAL: COPPER ALLOY  
 CONTACT TYPE: STAMPED  
 CONTACT PLATING: SELECTIVE GOLD  
 SHIELDING:  
 TOP: STAINLESS STEEL NI PLATED  
 SOLDER TAIL: GOLD PLATED

QUALITY CLASS: 5000 MATING CYLCES

ENVIRONMENTAL  
 OPERATING TEMPERATURE: -25°C UP TO +85°C  
 COMPLIANCE: LEAD FREE AND ROHS

ELECTRICAL  
 CURRENT RATING: 1.0A  
 WORKING VOLTAGE: 30V AC  
 INSULATION RESISTANCE: >1000 MΩ  
 WITHSTANDING VOLTAGE: 500 VAC/min  
 CONTACT RESISTANCE: 30mΩ max

SOLDERING  
 JEDEC LEAD FREE REFLOW SOLDERING PROCESS

PACKAGING  
 TAPE & REEL

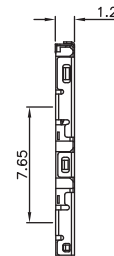
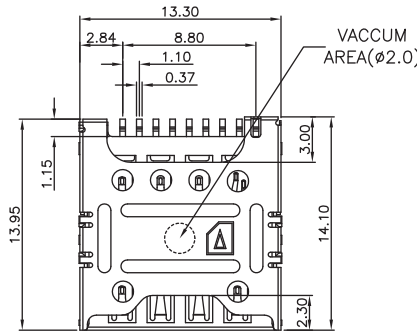
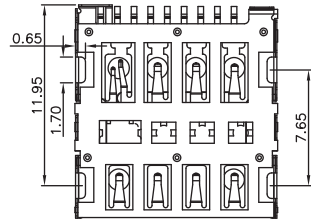
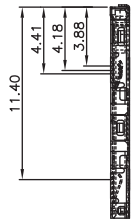
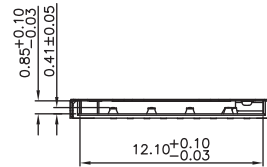
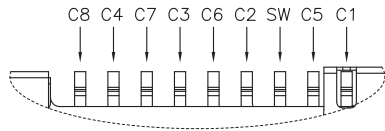

RoHS Compliant			
G			
F			
E			
D			
C	04-MAR-18	LAYOUT	AK
B	07-OCT-14	DWG UPDATE	QL
A	29-JUL-14	PDF	AS
REV	DATE	FILE	BY

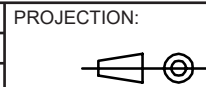

PROJECTION:  
 APPROVAL: RJ

GENERAL TOLERANCE  
 .X = +/- 0.2  
 .XX = +/- 0.15



DESCRIPTION: MICRO SIM - PUSH & PULL TYPE - 8 PINS

WERI PART NO: 693 023 010 811

SIZE  
**A4**

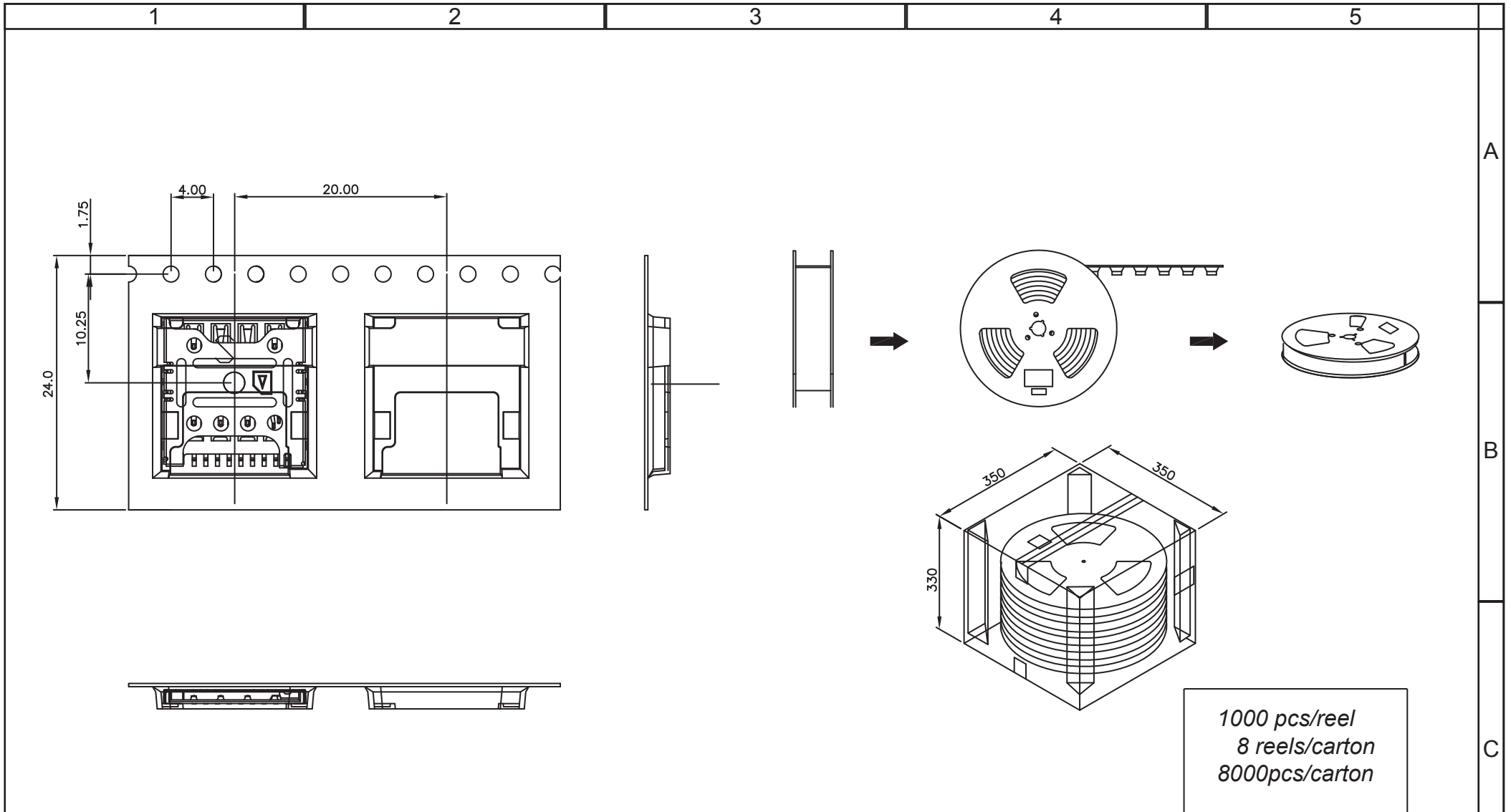

RoHS Compliant			
G			
F			
E			
D			
C			
B			
A	23-JUL-14	PDF	AS
REV	DATE	FILE	BY

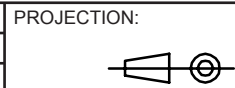

APPROVAL: RJ

GENERAL TOLERANCE  
.X =  $\pm 0.2$   
.XX =  $\pm 0.15$

UNIT: MM  
SCALE:  
SHEET: 2/3  
DRAW: AS



DESCRIPTION: MICRO SIM - PUSH & PULL TYPE - 8 PINS

WERI PART NO: 693 023 010 811

SIZE  
**A4**

1000 pcs/reel  
8 reels/carton  
8000 pcs/carton

1

2

3

4

5

## Cautions and Warnings:

This electronic component is designed and developed with the intention for use in general electronics equipments.

Before incorporating the components into any equipments in the field such as aerospace, aviation, nuclear control, submarine, transportation, (automotive control, train control, ship control), transportation signal, disaster prevention, medical, public information network etc. where higher safety and reliability are especially required or if there is possibility of direct damage or injury to human body, Würth Elektronik must be asked for a written approval.



In addition, even electronic component in general electronic equipments, when used in electrical circuits that require high safety, reliability functions or performance, the sufficient reliability evaluation-check for the safety must be performed before by the user before usage.

A

B

C

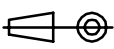
RoHS Compliant

G				PROJECTION: 	GENERAL TOLERANCE .X = +/- 0.2 .XX = +/- 0.15		
F							
E							
D							
C				APPROVAL: JC	UNIT: MM	DESCRIPTION: DISCLAIMER	SIZE <b>A4</b>
B					SCALE:		
A	10-SEP-14	PDF	QL		SHEET: 3/3	WERI PART NO: DISCLAIMER	
REV	DATE	FILE	BY		DRAW: QL		

D