

NOTE:

- 1.OPEN/SHORT/INTERMITTENCE:100%.
- 2.CONDUCTIVE RESISTANCE:2Ω (MAX)
- 3.RoHS & REACH Compliant
- 4.HDTV:4K*2K@60Hz

Pin OUT

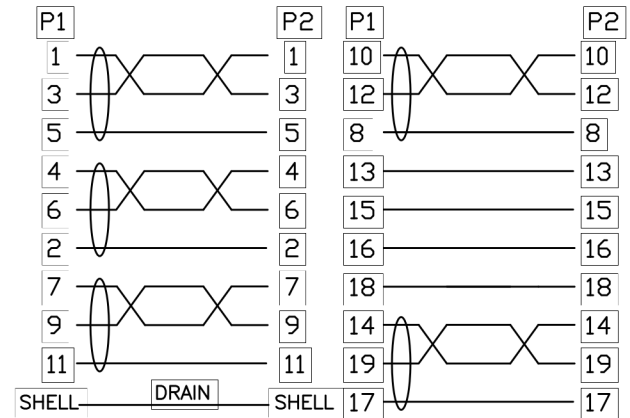

⑦	THUMB SCREW	#4-40*15	2	PCS
⑥	THUMB SCREW	NUT-NICKEL PLATED#4-40	2	PCS
⑤	MOLDED	45P BLACK PVC		G
④	MOLDED	LD-PE		G
③	CONNECTOR	HDMI A-FEMALE NICKEL PLATED WITH BLACK RUBBER COVER	1	PCS
②	CONNECTOR	HDMI A-FEMALE NICKEL PLATED	1	PCS
①	CABLE	(7/0.12TC*1P+7/0.12TC+FAM)*5+7/0.12TC*4C+AL+1/0.32BC+B(80/0.12ALM)+BLACK PVC OD:7.3±0.2MM	L	MM
NO.	MATERIAL	DESCRIPTION	QTY.	UNIT

Ltemref	Quantity	Title/Name,designation,material,dimension etc	Article No./Reference		
Designed by ALVIN	Checked by HELEN	Approved by - date 10-09-2019	File name	Date 10-09-2019	Scale FREE
ANGLE:				HDMI2.0 Panel Mount Female/Normal Female 0.3M	
UNIT:MM				Edition 1	Sheet 1/1