

Handwheels • DIN 950 cast iron

24580.0531

Product Description

Hub machined; rim turned and mirror-finished on all sides, non-machined surfaces cleanly blasted.

Material

Handwheel

- Cast iron GG

Machine handle DIN 39 EH 24450.

- Steel, turned, zinc-plated by galvanization, passivated

Assembly

Shaft-end washers EH 22270. for axial fastening.

More information

Further products

- Shaft-End Washers
- Rotating Machine Handles, DIN 98



Drawing

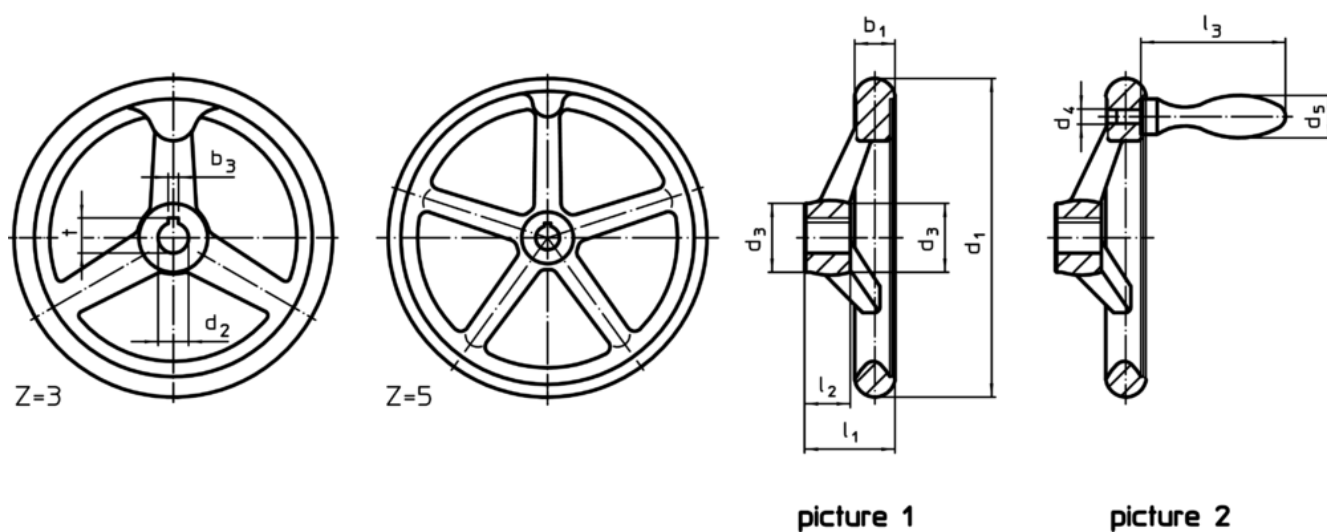

The orientation of the hub keyway may be different than shown in the drawing.

Order information

Dimensions								Hub keyway, DIN 6885 sheet 1		Number of spokes z	Corresponding machine handle DIN 39 / DIN 98	[g]	Art. No.
d ₁	d ₂ H7	d ₃	d ₄	d ₅	l ₁ ~	l ₂	l ₃ ~	b ₃	t				
with keyway, with machine handle EH 24450. assembled, form N-F/G (formerly: F 3) – picture 2													
200	22	38	M10	25	45	24	80	6	24.8	3	25	2180	24580.0531

Application example



Compliance

RoHS compliant

Compliant according to Directive 2011/65/EU and Directive 2015/863

Does not contain SVHC substances

No SVHC substances with more than 0.1% w/w contained - SVHC list [REACH] as of 10.06.2022

Does not contain Proposition 65 substances

No Proposition 65 substances included

<https://www.P65Warnings.ca.gov/>

Free from Conflict Minerals

This product does not contain any substances designated as "conflict minerals" such as tantalum, tin, gold or tungsten from the Democratic Republic of Congo or adjacent countries.