

Switches And Data  
Input Units.  
Quality And A Wide  
Range.  
Custom Components  
According To Your  
Requirements.

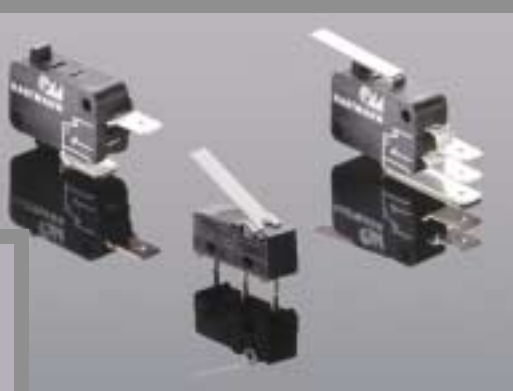

[www.hartmann-codier.de](http://www.hartmann-codier.de)



## PCB Code Switches **PRINTHART**

Our series is laid out for professional technology with modern assembly processes. They have solid PCB terminals outline the contact fingers are goldplated and the contact paths have an abrasion-resistant gold overlay. The contact resistance is low and stable.

These types are available with 10- or 16-positions in BCD, BCD complement, hexadecimal and hexadecimal complement. On request our PT65 can be delivered in 4, 6 and 8 position types as well.

P36 and P60A are available also in SMT.

Besides the "3+3" pin configuration with two common connections Hartmann offer the P60A in a "4+1" pin configuration.

This system has on one side common connection and on the opposite side 4 outgoing connections.

For all series different actuators are available. Therefore solutions for most applications can be met. Figures are clearly visible and detention mechanism is precise.

The switches of our PRINTHART series are quality products.

Hartmann is approved to ISO 9001. All switches are subject to electronic final check.

Hartmann PCB code switches can be found in all electronic fields.

Not every demand can be fulfilled with standard switches. More and more special executions are required. We are ready and – due to our expertise, and the vertically integrated manufacture – we are in the position to respond to your wishes. Please contact us also, if you don't find the optimum switch for your requirements. We will find a solution.

### Note

All dimensions are given in mm. Mounting hole patterns and layouts are drawn from component side.

The tolerance range, in most cases, is in accordance with "DIN 7168 medium".

We reserve the right to undertake modifications in the interest of technical progress. The catalogue represents the latest level of technology on the day it was published.

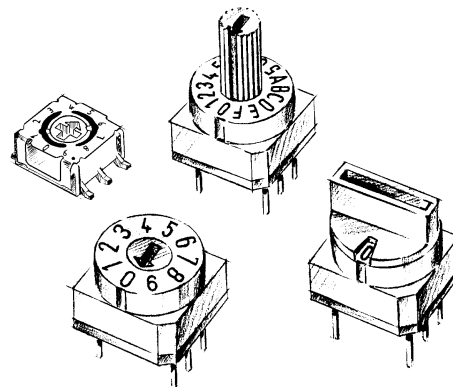

## Standard Types

Series/types	P36	P36S	P60A	P60AS	PT65	PT65 .31	P
Dimensions W/D/H	7,4/7,4/3,65	7,4/7,4/3,85	10/10/6,0	10/10/6,2	10/10/6,75	10/10/6,75	10/10/8,8
Catalogue page	8	8	10	10	12	14	15

### Standard actuation

Arrow-shaped slot	■	■	■	■	■	■	■
Rectangular-shaped slot							■
Spindle	■	■	■	■*	■	■	
Segment wheel			■	■*	■	■	
Cross-shaped slot			■	■	■	■	
Slotted spindle	■	■					

### Connection type

3+3	■	■			■	■	■
4+1			■	■			

### Terminals

Straight	■		■		■	■	■
Crimped	■		■		■	■	■
Angular L2,54	■				■	■	■
Angular L5,08			■		■	■	■
SMT		■		■			

### Standard-Codes

BCD	■	■	■	■	■		■
BCD Complement	■	■	■	■	■		■
Hexadecimal	■	■	■	■	■		■
Hexadecimal Compl.	■	■	■	■	■		■
Pulse generator						■	

\* only to be fitted after the soldering process

## Order description

**P36101L254**

Series	Standard actuators	Codes	Terminals
P36, P36S	1 = arrow-shaped slot	01 = BCD	V = crimped
P60A, P60AS	2 = rectangular-shaped slot	02 = BCD Compl.	L254 = left angular 2,54mm
PT65	3 = spindle	03 = Hexadecimal	L508 = left angular 5,08mm
P	5 = segment wheel	06 = Hexa. Compl.	
	7 = cross-shaped slot	31 = Pulse generator	
	8 = slotted spindle		



**Angular  
SMT-Pins  
on Request!**

**Extra Sealed Design  
with High Temperature  
Resistance. Adapted for  
Reflow soldering.**

## Types P36.../P36S...

Height: 3,65mm (SMT: 3,85mm)  
 Pin connection: 3 + 3  
 All standard codes  
 Available with spindle or slotted spindle  
 Straight, crimped, angular and  
 SMT pins



### Mechanical Data

Permiss. ambient temp.	-30°C – +90°C
Torque	min. 0,7Ncm
Expected life	min. 10 <sup>4</sup> steps
Positions per rotation	10, 16

### Electrical Data

Operating voltage	≤ 24V
Contact load, static	≤ 0,4A
Contact load, dynamic	≤ 0,10A
Test voltage	250V 50Hz/1min
Contact resistance	< 100 mOhm
Insulation resistance	> 100 MOhm

### Solder recommendations

(EN 61760-1; DIN IEC 60068-2-20)	
Solder reflow	max. 40s/215°C
Solder iron	max. 2s/340°C
Solder bath	max. 10s/260°C

### Standard actuators

See page 18

### Colour of rotor

BCD	red
BCD Complement	orange
Hexadecimal	grey
Hexadecimal Complement	white

Order description see page 9.

### Dimensions/Mounting hole patterns P36

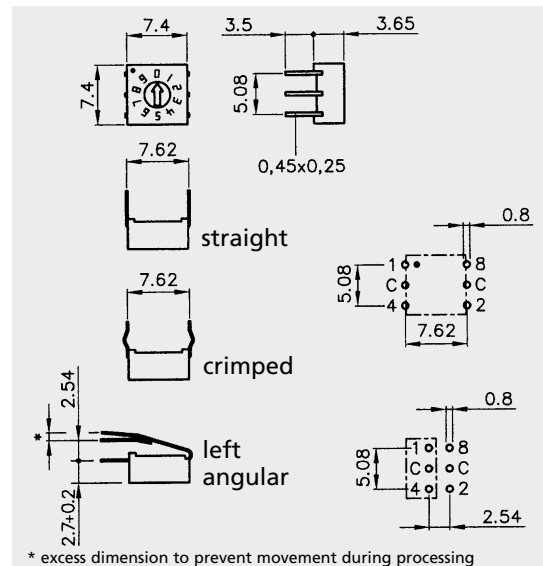

### Dimensions/Mounting hole patterns P36S

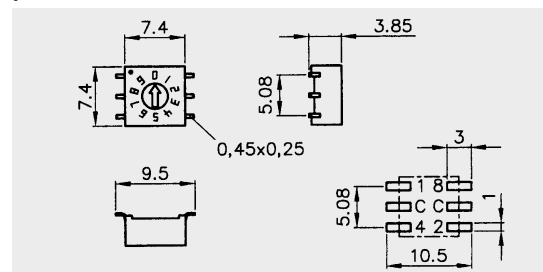

# Tape and Reel Packing Series P36S...

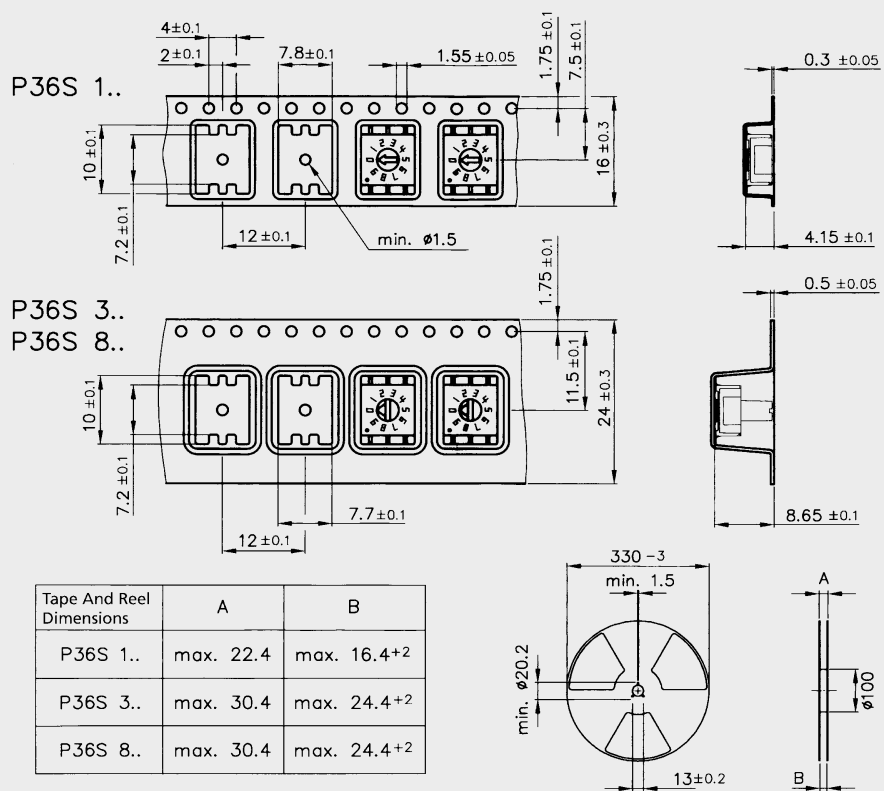

## advance and end section

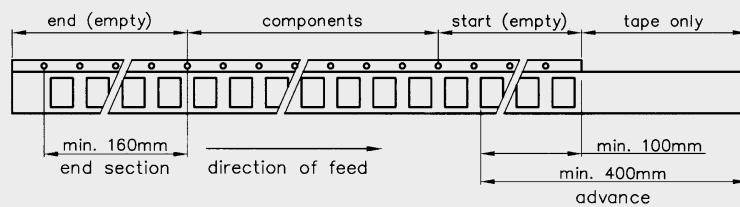

## peel strength, cover tape

0,1N ... 1.3N (10g ...130g)

direction of feed

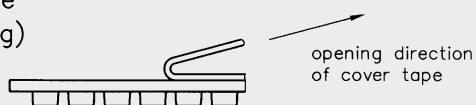

removal angle of cover tape: 165°-180°  
removal speed: 300 ±10 mm/Minute



**Angular  
SMT-Pins  
on Request!**

**Extra Sealed Design  
with High Temperature  
Resistance. Adapted for  
Reflow soldering.**

## Typen P60A.../P60AS...

Height: 6,0mm (SMT: 6,2mm)  
Pin connection: 4 + 1  
All standard codes  
Individual operating elements  
Straight, crimped, angular and  
SMT pins

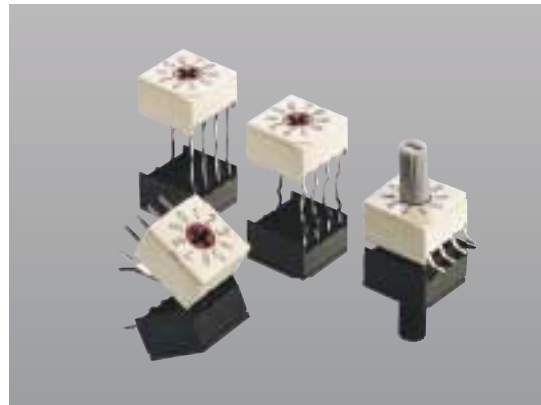

### Mechanical Data

Permiss. ambient temp.	-20°C – +85°C
Torque	min. 0,7Ncm
Expected life	min. 10 <sup>4</sup> steps
Positions per rotation	10, 16

### Electrical Data

Operating voltage	≤ 24V
Contact load, static	≤ 0,4A
Contact load, dynamic	≤ 0,15A
Test voltage	250V 50Hz/1min
Contact resistance	< 100mOhm
Insulation resistance	> 100MOhm

### Solder recommendations

(EN 61760-1; DIN IEC 60068-2-20)	
Solder reflow	max. 40s/215°C
Solder iron	max. 2s/340°C
Solder bath	max. 10s/260°C

### Standard actuators

See page 18

### Individual operating elements

See page 15

Order description see page 9.

### Dimensions/Mounting hole patterns P60A

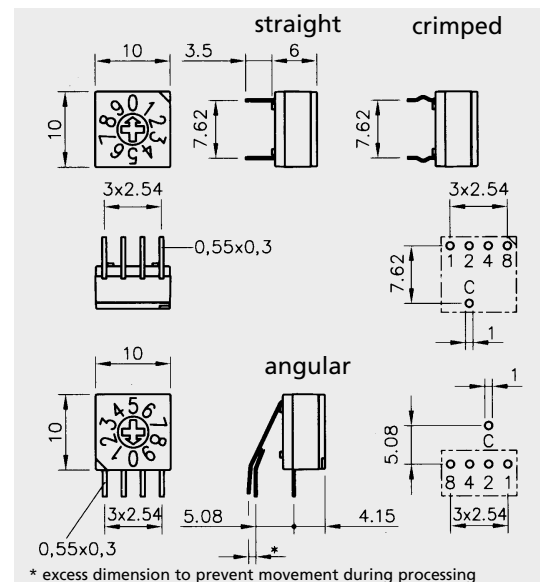

### Dimensions/Mounting hole patterns P60AS

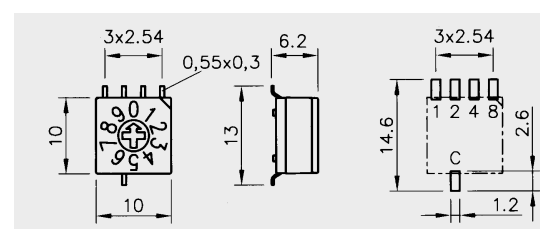

# Tape and Reel Packing Series P60AS...

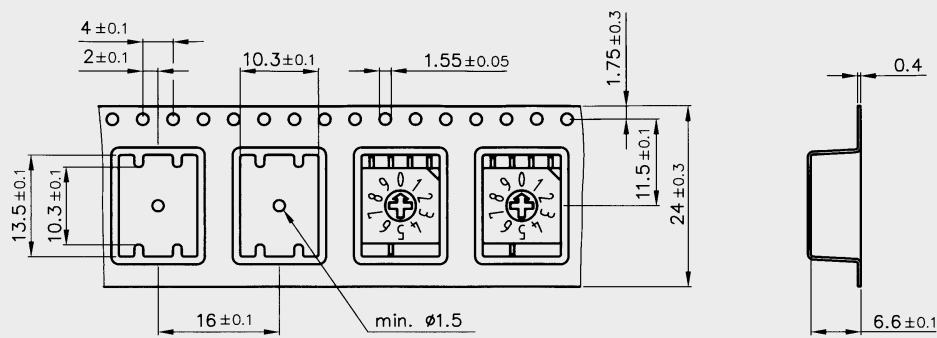

diameter of reel 329mm  
core diameter 100mm

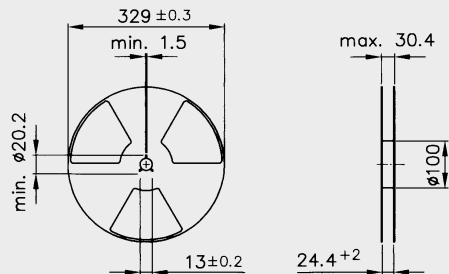

advance and end section

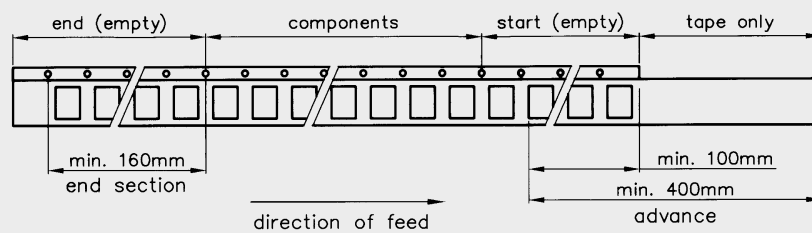

peel strength, cover tape  
0,1N ... 1.3N (10g ...130g)



removal angle of cover tape:  $165^\circ - 180^\circ$   
removal speed:  $300 \pm 10$  mm/Minute



**New! Stopped Switches  
on Request.**

## Type PT65...

Height: 6,5mm

Pin connection: 3 + 3

Screwdriver and cross-shaped slot types

All standard codes

Straight, crimped and angular pins

Available with spindle or segment wheel

Extra sealed Design



### Mechanical Data

Permiss. ambient temp.	-20°C – +70°C
Torque	min. 0,7Ncm
Expected life	min. 10 <sup>4</sup> steps
Positions per rotation	10, 16

### Electrical Data

Operating voltage	≤ 24V
Contact load, static	≤ 0,4A
Contact load, dynamic	≤ 0,15A
Test voltage	250V 50Hz/1min
Contact resistance	< 80 mOhm
Insulation resistance	> 100 MOhm

### Solder recommendations

(DIN IEC 60068-2-20)	
Solder iron	max. 2s/340°C
Solder bath	max. 10s/260°C

### Standard actuators

See page 18

Order description see page 9.

### Dimensions/Mounting hole patterns

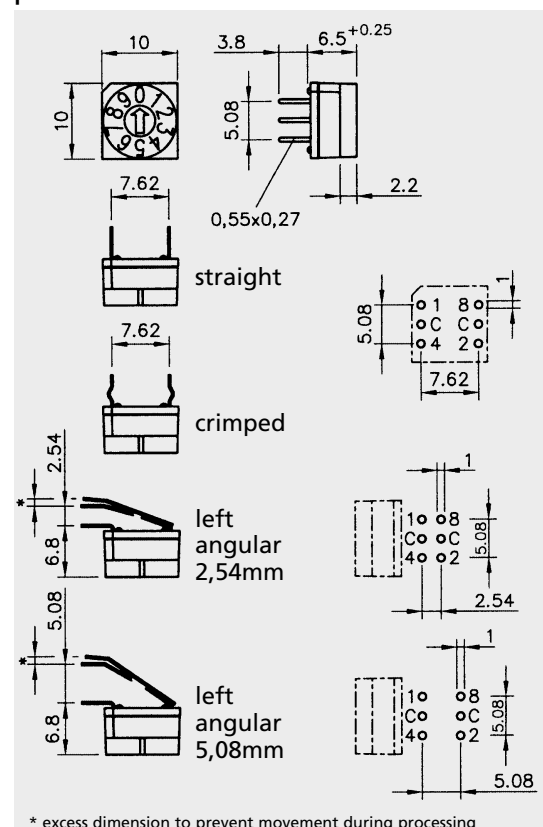



# Operating elements for cross-shaped slot-types

Both types PT65 and P60A are available with cross-shaped slots and can be fitted either by the factory or afterwards with the actuators. Elements are available individually under the following order description. The required colour must be added to the text.



## Segment wheel \*

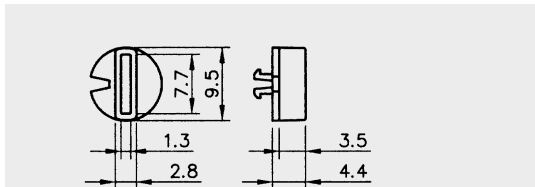

Order description  
SR-PT65 9,5/4,4  
Colours: yellow, red, green, blue, grey or black

## Spindle \*

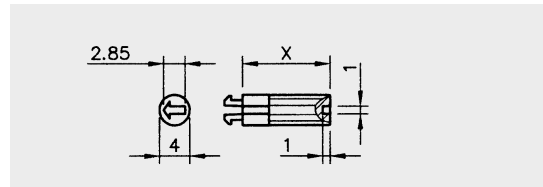

Order description  
SA-PT65 4/x (x = 7,3; 11,6; 13,3)  
Colours: grey, red, black

## Wheel (only PT65)

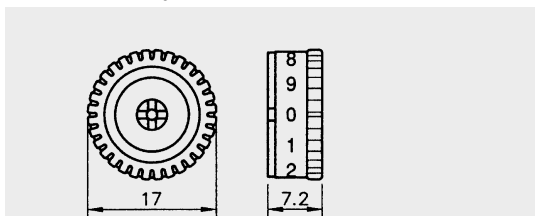

Order description  
DR-PT65 17  
Colour: white (number printing on request)

## Knob \*

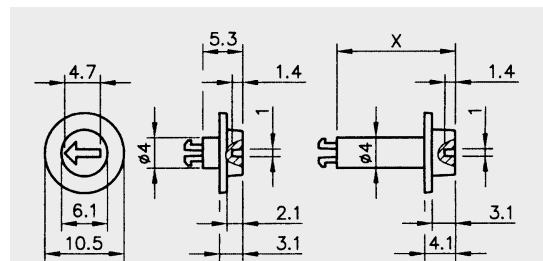

Order description  
DK-PT65 10,5/5,3  
DK-PT65 10,5/x (x = 15,7; 29,1; 34,4)  
Colour: red

\* In case of P60 AS to be fitted after soldering.



## Wiring diagramme

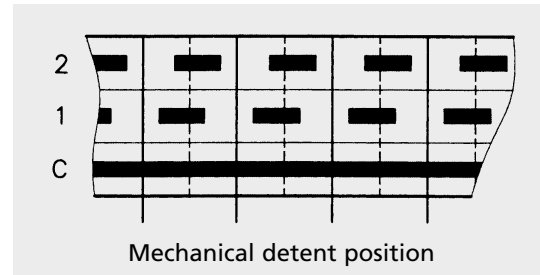

## Type PT65.31

The pulse generator is a mechanical rotary switch connecting input C to outputs 1 and 2 after another in a retarded manner. In the mechanical detent position input C is galvanically separated from the outputs 1 and 2.

Depending on the rotational direction of the axis, the switching sequence is

rotation to right (clockwise) C+1, C+1+2, C+2

rotation to left (counterclockwise) C+2, C+2+1, C+1

Hereby, the rotational direction is recognized electrically. Typical applications are to be found wherever adding or subtracting instructions are read into digital electronics (dimmer, volume control).



### Mechanical Data

Permiss. ambient temp.	-20°C – +70°C
Torque	min. 0,7Ncm
Expected life	min. 10 <sup>4</sup> steps
Positions per rotation	10

### Electrical Data

Operating voltage	≤ 24V
Contact load, static	≤ 0,4A
Contact load, dynamic	≤ 0,15A
Test voltage	250V 50Hz/1min
Contact resistance	< 80 mOhm
Insulation resistance	> 100 MOhm
Contact bounce	< 10ms*
Pulse duration	
C + Pin 1	> 50ms*
C + Pin 1 + Pin 2	> 100ms*
C + Pin 2	> 50ms*

\* Data valid at 15 rpm

### Solder recommendations

(DIN IEC 60068-2-20)

Solder iron	max. 2s/340°C
Solder bath	max. 10s/260°C

Order description see page 9.

### Dimensions/Mounting hole patterns

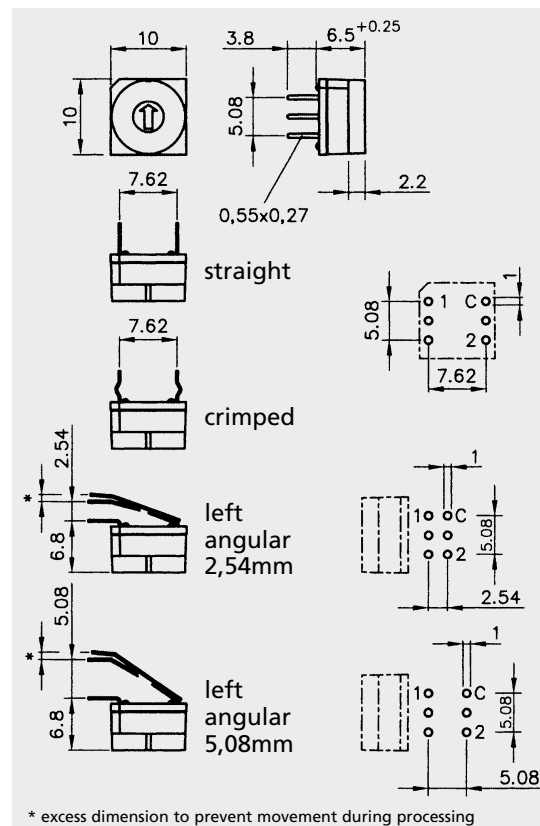

## Type P...

Height: 8,6mm

Pin connection: 3 + 3

All standard codes

Available with spindle or rectangular shaped slot

Straight, crimped and angular pins



### Mechanical Data

Permiss. ambient temp.	-20°C – +70°C
Torque	min. 0,7Ncm
Expected life	min. 10 <sup>4</sup> steps
Positions per rotation	10, 16

### Electrical Data

Operating voltage	≤ 24V
Contact load, static	≤ 0,4A
Contact load, dynamic	≤ 0,15A
Test voltage	250V 50Hz/1min
Contact resistance	< 80 mOhm
Insulation resistance	> 100 MOhm

### Solder recommendations

(DIN IEC 60068-2-20)

Solder iron	max. 2s/340°C
Solder bath	max. 5s/260°C

### Knob

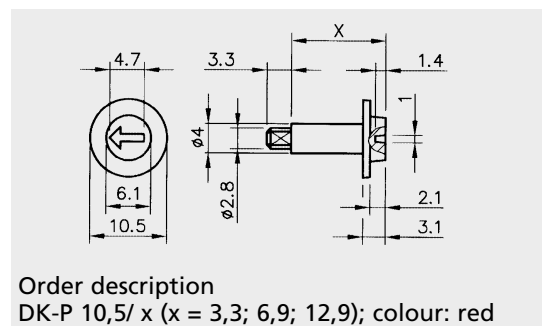

### Standard actuators

See page 18

Order description see page 9.

### Dimensions/Mounting hole patterns

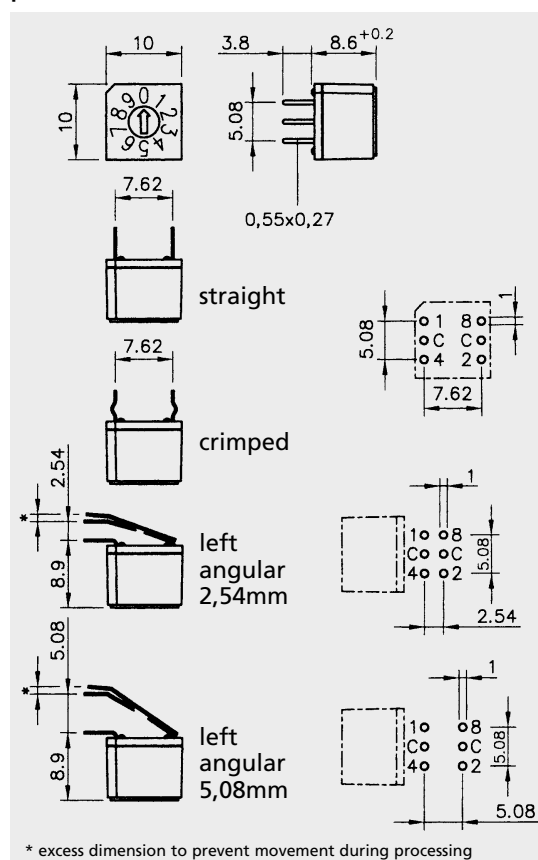

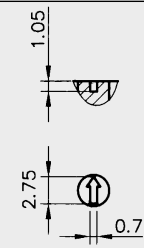
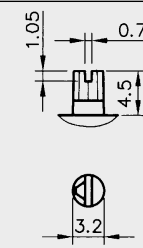
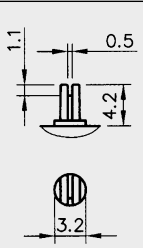
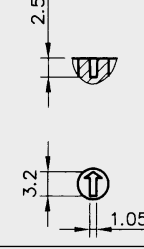
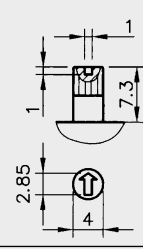
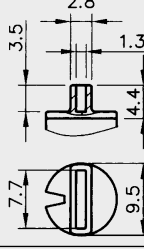
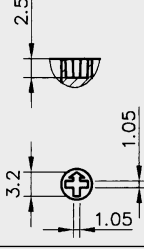
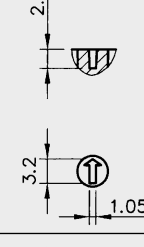
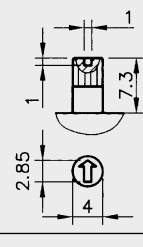
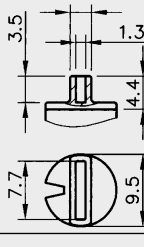
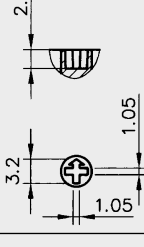
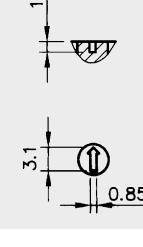
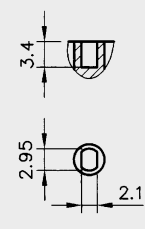

# Standard actuators

Operation / Series/ Types	Arrow-shaped slot Order-No. 1	Rectangular-shaped slot Order-No. 2	Spindle Order-No. 3	Segment wheel Order-No. 5	Cross-shaped slot Order-No. 7	Slotted spindle Order-No. 8
<b>P36</b> <b>P36S</b> Colour: according to code						
<b>PT65</b> Colour: grey						
<b>P60A</b> <b>P60AS</b> Colour: red						
<b>P</b> Colour: grey						

# Codes

## Standard

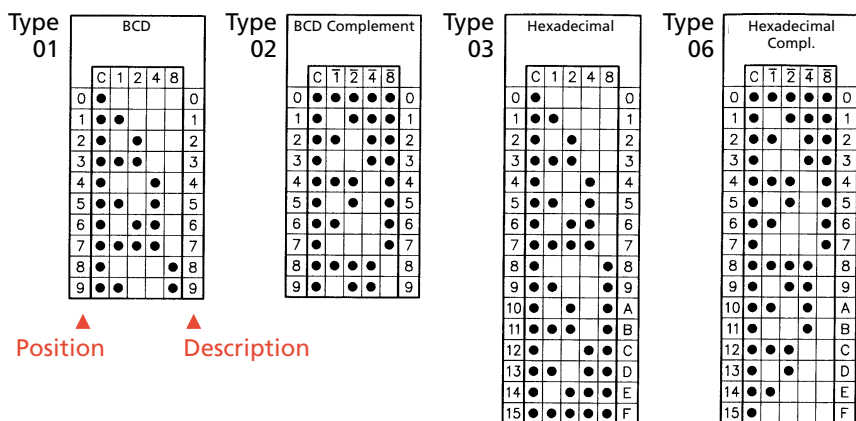

## On Request

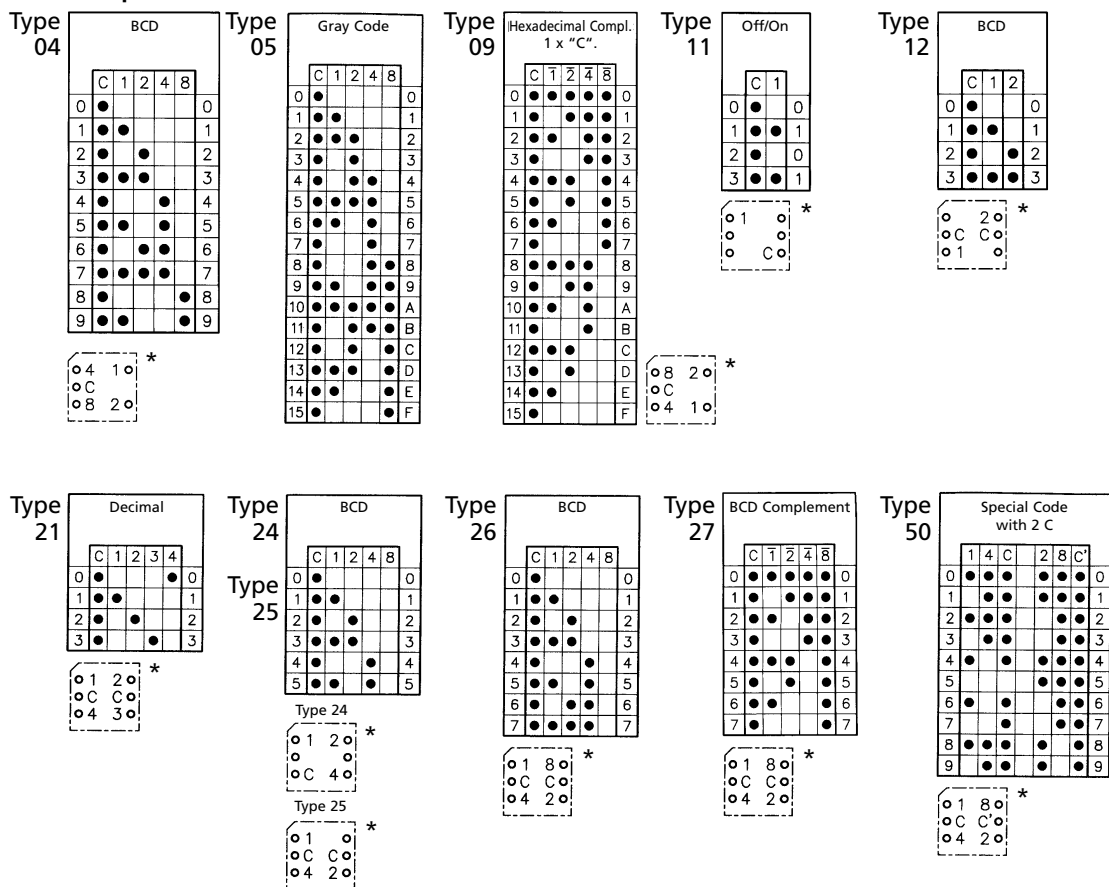



**HARTMANN**

A Phoenix Mecano Company

Hartmann Codier  
GmbH & Co. KG  
Industriestraße 3  
D-91083 Baiersdorf  
Tel.: +49 91 33/77 93-0  
Fax: +49 91 33/42 35  
+49 91 33/77 93 36 (Sales)  
[www.hartmann-codier.de](http://www.hartmann-codier.de)  
e-mail: [info@hartmann-codier.de](mailto:info@hartmann-codier.de)

999938 02/2002