

55 Raised design

Illuminated pushbutton square 18 x 18 mm

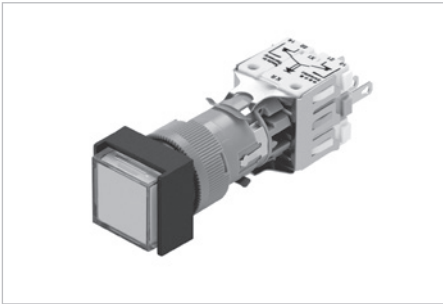

Product can differ from the current configuration.

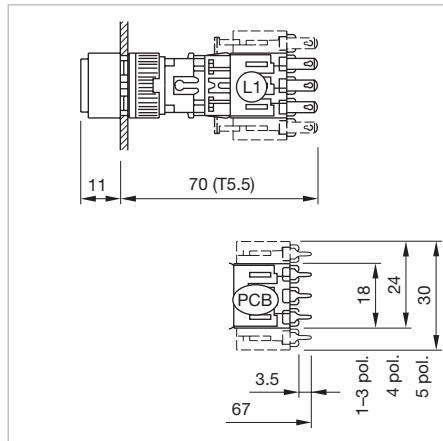

Dimensions [mm]
L1 = Solder terminal 2.8 x 0.5 mm,
PCB = Print terminal

Equipment consisting of (schematic overview)

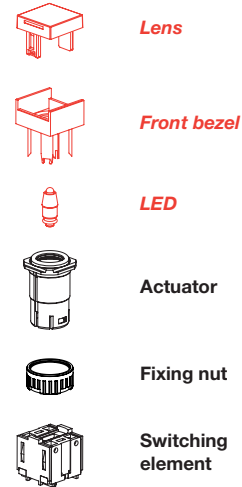

Additional Information

- For the flush design please order the additional front bezel set, see chapter «Accessories»
- Protection degree IP 40/IP 65 is determined by front bezel and lens
- Maintain to momentary action is switchable, reversible

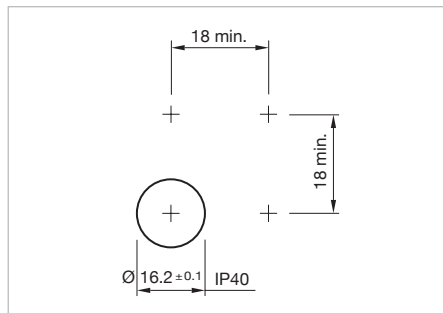

Mounting cut-outs [mm]

Each Part Number listed below includes all the black components shown in the 3D-drawing.

To obtain a complete unit, please select the red components from the pages shown.

Switching system	Behind panel depth	Contacts	Switching action	Lamp socket	Terminal	Part No.	Wiring diagram	Weight
 Illuminated pushbutton actuator square, Front dimension 18 x 18 mm								
Snap-action switching element	70 mm	1 NC + 1 NO	C - B	T5.5	Solder 2.8 x 0.5 mm	801F.000-00	1	0.015 kg
		2 NC + 2 NO	C - B	T5.5	Solder 2.8 x 0.5 mm	802F.000-00	2	0.016 kg



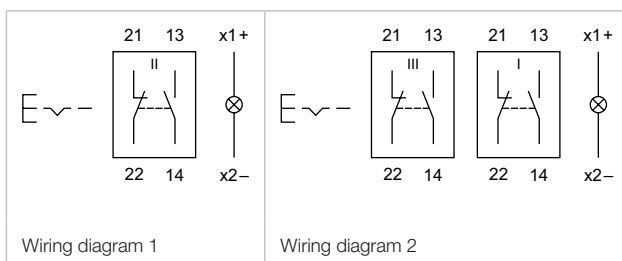

Contacts: NC = Normally closed, NO = Normally open
Switching action: B = Momentary, C = Maintained



Front bezel

Additional Information

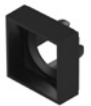
- Front bezel IP 65 is supplied with fitted sealing ring.

Product attribute	Front protection	Front bezel	Part No.	Weight
 <p>Front bezel square, 18 x 18 mm</p>	IP 40	Plastic grey	200-3000-00	0.002 kg
		Plastic black	200-4000-00	0.002 kg
 <p>Front bezel rectangular, 18 x 24 mm</p>	IP 40	Plastic grey	200-5000-00	0.002 kg
		Plastic black	200-6000-00	0.002 kg
 <p>Front bezel round, 18 mm</p>	IP 40	Plastic grey	200-1000-00	0.002 kg
		Plastic black	200-2000-00	0.002 kg
 <p>Front bezel square, 24 x 24 mm</p>	IP 40	Plastic grey	200-9000-00	0.002 kg
		Plastic black	200-0000-00	0.002 kg
	IP 65	Plastic grey	200-9000-W0	0.002 kg
		Plastic black	200-0000-W0	0.002 kg
 <p>Front bezel round, 24 mm</p>	IP 40	Plastic grey	200-7000-00	0.002 kg
		Plastic black	200-8000-00	0.002 kg
	IP 65	Plastic grey	200-7000-W0	0.002 kg
		Plastic black	200-8000-W0	0.002 kg