

Face milling cutters, 45°

For SEET 12T3... indexable milling inserts

ORION[®]

Application:

For universal use in all materials, predestined for cast processing.

Execution:

- Nickel-plated supports
- Long-term tested support design
- Normal and fine pitch
- Clamping screw tightening torque (indexable insert) M3.5 = 3.9 Nm

Advantage:

- Highly positive indexable milling inserts for low-vibration, steady cutting
- Outstanding value for money

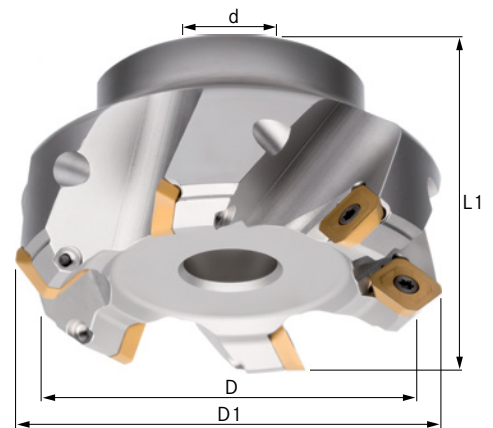

Art. no.	16003 202
Brand	ORION
Manufacturer Part Number	16003202
Min. cutting edge diameter	80 mm
Max. cutting edge diameter	91 mm
Length	50 mm
Bore diameter	27 mm
max. ap	6 mm
Number of cutting edges	4 PCS
Gross Weight	1.442 kg
Product Group	148

EAN

4039247532278

