

1 Form A Plug-in type



Form A type also available with 48A contact capacity

Refer to data sheet, starting on [page 9](#).

FEATURES

1. Excellent resistance to contact welding

Owing to the pre-tension and kick-off mechanism, the 1 Form A passes TV-15 and the 2 Form A passes TV-10.

2. High-capacity and long life

Contact arrangement	1 Form A type	2 Form A type
Contact capacity	30A	20A
Electrical life (at 20 cpm)	2×10 ⁵	
Mechanical life (at 180 cpm)	DC type: 10 ⁷ , AC type: 5×10 ⁶	

3. Excellent surge resistance

Between contacts and coil, the surge voltage is more than 10,000 V (when surge waveform accords with JEC-212-1981).

4. Compatible with all major safety standards

UL, CSA, VDE and TÜV certified

TYPICAL APPLICATIONS

1. Office equipment

Copiers, package air conditioners, automatic vending machines.

2. Industrial equipment

Machine tools, molding equipment, wrapping machines, food processing equipment, etc.

3. Home appliances

Air conditioners, microwave ovens, televisions, stereo systems, water heaters and air heating equipment.

Type	Single side stable type HE 1 Form A, 2 Form A	
Insulation gap	Min. 8 mm	
Distance between contacts*	1 Form A and 2 Form A: Min. 3 mm	PC board type: Min. 2.5 mm
Breakdown voltage	Between open contacts	2, 000 Vrms for 1 min.
	Between contact and coil	5, 000 Vrms for 1 min.

CLASSIFICATION

Type	PC board	Plug-in	TM		Screw terminal		
Operating function	Single side stable						
Contact arrangement	1 Form A	1 Form A	2 Form A	1 Form A	2 Form A	1 Form A	2 Form A

PRE-TENSION AND KICK-OFF MECHANISM

1. Pre-tension mechanism

Before operation, the moving spring is pre-tensioned by being held down by a moving plate. As a result, at the ON moment, with little follow, contact pressure is ensured with low bounce.

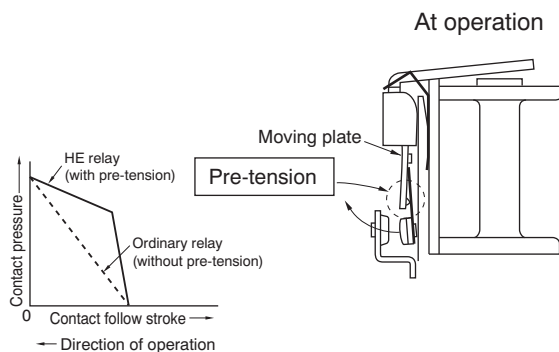

2. Kick-off mechanism

Even when contact welding has occurred, at the moment of return, the moving plate taps the moving spring (kick-off) and, in effect, works to tear the weld apart, thus improving resistance to welding.

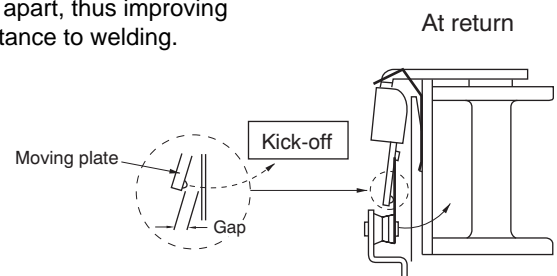

	1 Form A	2 Form A
Electrical life	30 A 277 V AC, 10 ⁵ 30 A 250 V AC, 20 ⁵	25 A 277 V AC, 10 ⁵ 20 A 250 V AC, 20 ⁵
TV rating	TV-15	TV-10

ORDERING INFORMATION

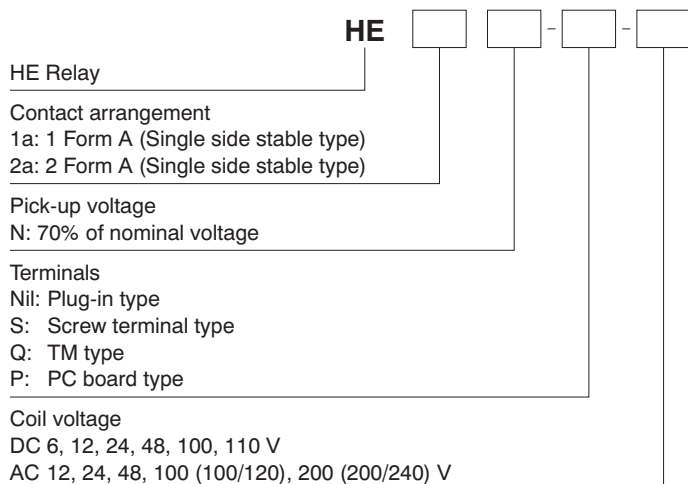

TYPES

1. PC board type (1 Form A, DC coil) (Single side stable)

Coil voltage	1 Form A		Packing quantity	
	Part No.		Carton	Case
6V DC	HE1aN-P-DC6V		25 pcs.	100 pcs.
12V DC	HE1aN-P-DC12V			
24V DC	HE1aN-P-DC24V			
48V DC	HE1aN-P-DC48V			
100V DC	HE1aN-P-DC100V			
110V DC	HE1aN-P-DC110V			

2. Plug-in type (Single side stable)

Type	Coil voltage	1 Form A		2 Form A		Packing quantity	
		Part No.		Part No.		Carton	Case
DC type	6V DC	HE1aN-DC6V	HE2aN-DC6V	20 pcs.	100 pcs.		
	12V DC	HE1aN-DC12V	HE2aN-DC12V				
	24V DC	HE1aN-DC24V	HE2aN-DC24V				
	48V DC	HE1aN-DC48V	HE2aN-DC48V				
	100V DC	HE1aN-DC100V	HE2aN-DC100V				
	110V DC	HE1aN-DC110V	HE2aN-DC110V				
AC type	12V AC	HE1aN-AC12V	HE2aN-AC12V	20 pcs.	100 pcs.		
	24V AC	HE1aN-AC24V	HE2aN-AC24V				
	48V AC	HE1aN-AC48V	HE2aN-AC48V				
	100/120V AC	HE1aN-AC100V	HE2aN-AC100V				
	200/240V AC	HE1aN-AC200V	HE2aN-AC200V				

3. TM type (Single side stable)

Type	Coil voltage	1 Form A		2 Form A		Packing quantity	
		Part No.		Part No.		Carton	Case
DC type	6V DC	HE1aN-Q-DC6V	HE2aN-Q-DC6V	20 pcs.	100 pcs.		
	12V DC	HE1aN-Q-DC12V	HE2aN-Q-DC12V				
	24V DC	HE1aN-Q-DC24V	HE2aN-Q-DC24V				
	48V DC	HE1aN-Q-DC48V	HE2aN-Q-DC48V				
	100V DC	HE1aN-Q-DC100V	HE2aN-Q-DC100V				
	110V DC	HE1aN-Q-DC110V	HE2aN-Q-DC110V				
AC type	12V AC	HE1aN-Q-AC12V	HE2aN-Q-AC12V	20 pcs.	100 pcs.		
	24V AC	HE1aN-Q-AC24V	HE2aN-Q-AC24V				
	48V AC	HE1aN-Q-AC48V	HE2aN-Q-AC48V				
	100/120V AC	HE1aN-Q-AC100V	HE2aN-Q-AC100V				
	200/240V AC	HE1aN-Q-AC200V	HE2aN-Q-AC200V				

4. Screw terminal type (Single side stable)

Type	Coil voltage	1 Form A	2 Form A	Packing quantity	
		Part No.	Part No.	Carton	Case
DC type	6V DC	HE1aN-S-DC6V	HE2aN-S-DC6V	10 pcs.	50 pcs.
	12V DC	HE1aN-S-DC12V	HE2aN-S-DC12V		
	24V DC	HE1aN-S-DC24V	HE2aN-S-DC24V		
	48V DC	HE1aN-S-DC48V	HE2aN-S-DC48V		
	100V DC	HE1aN-S-DC100V	HE2aN-S-DC100V		
AC type	110V DC	HE1aN-S-DC110V	HE2aN-S-DC110V	10 pcs.	50 pcs.
	12V AC	HE1aN-S-AC12V	HE2aN-S-AC12V		
	24V AC	HE1aN-S-AC24V	HE2aN-S-AC24V		
	48V AC	HE1aN-S-AC48V	HE2aN-S-AC48V		
	100/120V AC	HE1aN-S-AC100V	HE2aN-S-AC100V		
	200/240V AC	HE1aN-S-AC200V	HE2aN-S-AC200V		

Note: The TM type of the screw terminals are also available.

RATING**1. Coil data****1) AC coils**

Coil voltage	Pick-up voltage (at 20°C 68°F)	Drop-out voltage (at 20°C 68°F)	Nominal operating current [±10%] (at 20°C 68°F)	Nominal operating power	Max. allowable voltage (at 20°C 68°F)
12V AC	70%V or less of nominal voltage (Initial)	15%V or more of nominal voltage (Initial)	138mA	1.7VA	110%V of nominal voltage
24V AC			74mA	1.8VA	
48V AC			39mA	1.9VA	
100/120V AC			18.7 to 2.1mA	1.9 to 2.7VA	
200/240V AC			9.1 to 10.8mA	1.8 to 2.6VA	

2) DC coils

Coil voltage	Pick-up voltage (at 20°C 68°F)	Drop-out voltage (at 20°C 68°F)	Nominal operating current [±10%] (at 20°C 68°F)	Coil resistance [±10%] (at 20°C 68°F)	Nominal operating power	Max. allowable voltage (at 55°C 131°F)
6V DC	70%V or less of nominal voltage (Initial)	10%V or more of nominal voltage (Initial)	320mA	18.8Ω	1.92W	110%V of nominal voltage
12V DC			160mA	75Ω	1.92W	
24V DC			80mA	300Ω	1.92W	
48V DC			40mA	1,200Ω	1.92W	
100V DC			19mA	5,200Ω	1.92W	
110V DC			18mA	6,300Ω	1.92W	

2. Specifications

Characteristics	Item	Specifications		
		1 Form A	2 Form A	
Contact	Arrangement	1 Form A	2 Form A	
	Initial contact resistance, max	Max. 100 mΩ (By voltage drop 6 V DC 1A)		
	Contact material	AgSnO ₂ type		
Rating	Nominal switching capacity (resistive load)	30A 277V AC	25A 277V AC	
	Max. switching power	8,310VA	6,925VA	
	Max. switching voltage	277V AC, 30V DC		
	Max. switching current	30A	25A	
	Nominal operating power	DC: 1.92W, AC: 1.7 to 2.7VA		
	Min. switching capacity (Reference value)*1	100mA 5V DC		
Electrical characteristics	Insulation resistance (Initial)	Min. 1,000MΩ (at 500V DC) Measurement at same location as "Initial breakdown voltage" section.		
	Breakdown voltage (Initial)	Between open contacts	2,000 Vrms for 1min (Detection current: 10mA.)	
		Between contact sets	—	4,000 Vrms for 1min (Detection current: 10mA.)
		Between contact and coil	5,000 Vrms for 1min (Detection current: 10mA.)	
	Surge breakdown voltage ² (between contact and coil)	Min. 10,000V (initial)		
	Temperature rise	DC: Max. 60°C (at 55°C) (By resistive method), AC: Max. 65°C (at 55°C) (By resistive method)		
	Operate time (at nominal voltage)	Max. 30ms (excluding contact bounce time)		
Release time (at nominal voltage)	DC: Max. 10ms (excluding contact bounce time, without diode), AC: Max. 30ms (excluding contact bounce time)			
Mechanical characteristics	Shock resistance	Functional	Min. 98 m/s ² (Half-wave pulse of sine wave: 11 ms; detection time: 10μs.)	
		Destructive	Min. 980 m/s ² (Half-wave pulse of sine wave: 6 ms.)	
	Vibration resistance	Functional	10 to 55 Hz at double amplitude of 1 mm (Detection time: 10μs.)	
		Destructive	10 to 55 Hz at double amplitude of 1.5 mm	
Expected life	Mechanical	DC: Min. 10 ⁷ (at 180 cpm), AC: Min. 5×10 ⁶ (at 180 cpm)		
	Electrical (resistive load) (at 20 cpm)	Min. 10 ⁵ (30A 277V AC) Min. 2×10 ⁵ (30A 250V AC)	Min. 10 ⁵ (25A 277V AC) Min. 2×10 ⁵ (20A 250V AC)	
Conditions	Conditions for operation, transport and storage ³	Ambient temperature: -50°C to +55°C -58°F to +131°F Humidity: 5 to 85% R.H. (Not freezing and condensing at low temperature), Air pressure: 86 to 106kPa		
	Conditions for operation, transport and storage ³	20 cpm (at max. rating)		
Unit weight		PC board type: approx. 80g 2.82oz, Plug-in type/TM type: approx. 90g 3.17oz, Screw terminal type: approx. 120g 4.23oz		

*1 This value can change due to the switching frequency, environmental conditions, and desired reliability level, therefore it is recommended to check this with the actual load.

*2 Wave is standard shock voltage of ±1.2×50μs according to JEC-212-1981

*3 Refer to "6. Usage, Storage and Transport Conditions" in [AMBIENT ENVIRONMENT](#) section in [Relay Technical Information](#).

REFERENCE DATA

1 Form A Type

1. Maximum switching power

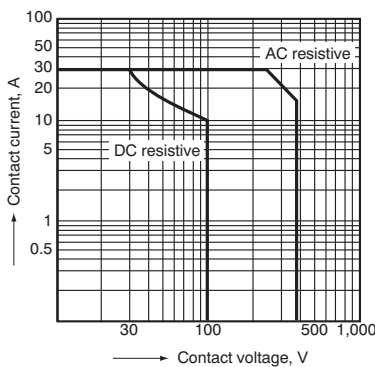

2. Life curve

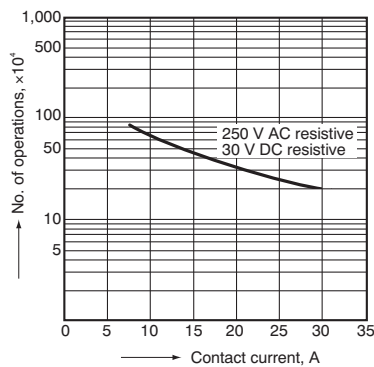

3. Coil temperature rise (DC type)

Measured portion: Inside the coil
Contact current: 30 A

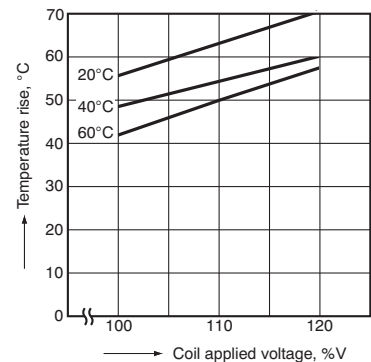

4. Ambient temperature characteristics

Tested sample: HE1aN-AC120V, 6 pcs.

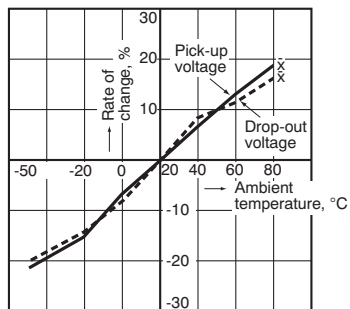

2 Form A Type

1. Maximum switching power

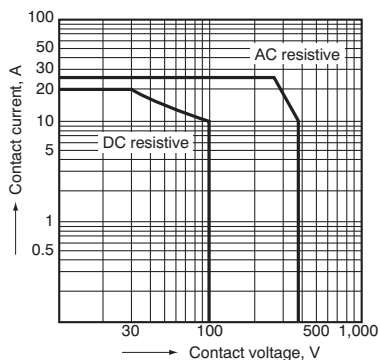

2. Life curve

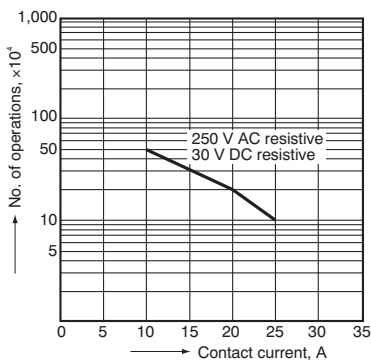

3. Coil temperature rise (DC type)

Measured portion: Inside the coil
Contact current: 30 A

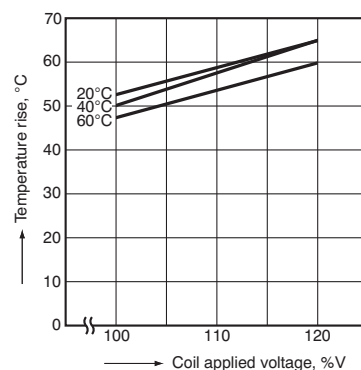

4. Ambient temperature characteristics

Tested sample: HE2aN-AC120V, 6 pcs.

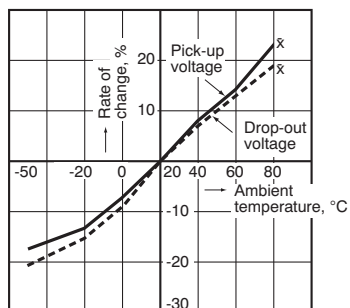

DIMENSIONS (mm inch)

Download [CAD Data](#) from our Web site.

1. PC board type

1 Form A [CAD Data](#)

External dimensions
Single side stable type

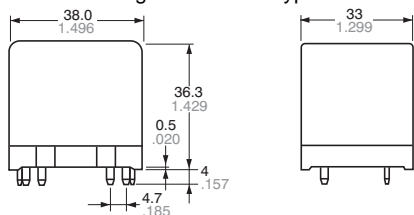

Schematic (Bottom view)
Single side stable type

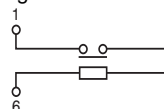

PC board pattern (Bottom view)

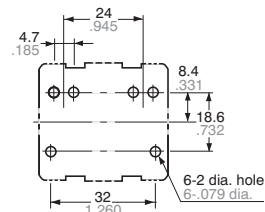

General tolerance: $\pm 0.3 \pm 0.012$

Tolerance: $\pm 0.1 \pm 0.004$

2. Plug-in type

1 Form A [CAD Data](#)

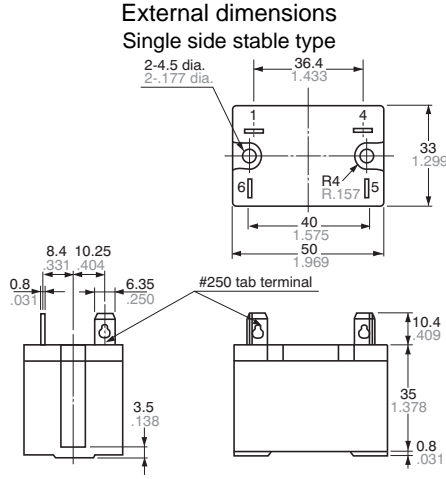

Schematic (Bottom view)
Single side stable type

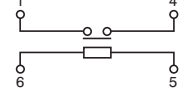

Panel cutout

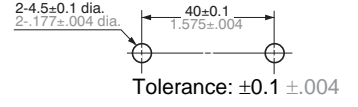

General tolerance: $\pm 0.3 \pm .012$

2 Form A [CAD Data](#)

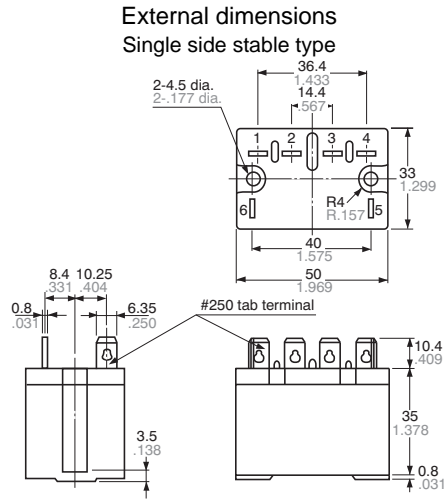

Schematic (Bottom view)
Single side stable type

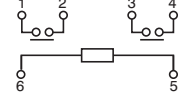

Panel cutout

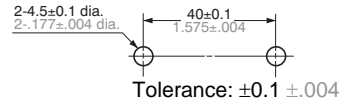

General tolerance: $\pm 0.3 \pm .012$

3. TM type

[CAD Data](#)

External dimensions
Single side stable type
1 Form A

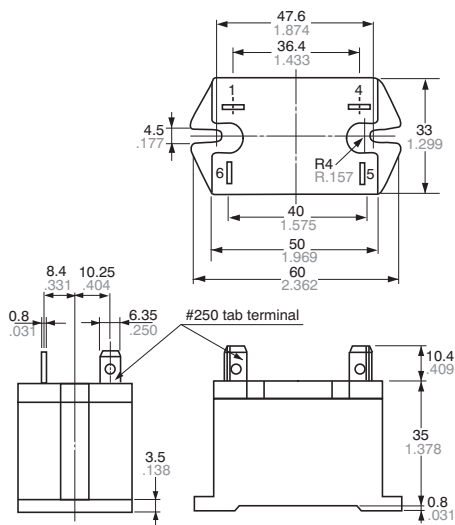

2 Form A

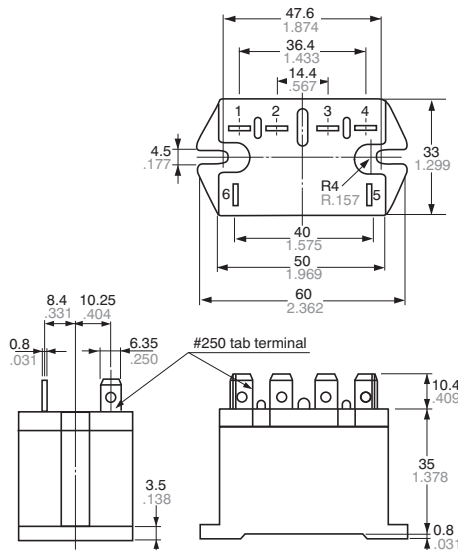

Schematic (Bottom view)
Single side stable type

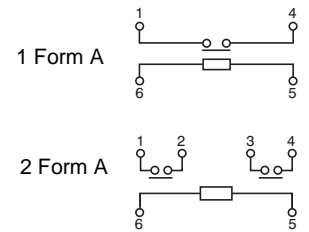

Panel cutout

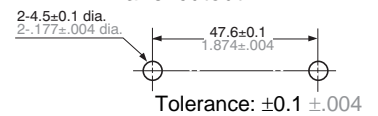

General tolerance: $\pm 0.3 \pm .012$

4. Screw terminal type

1 Form A [CAD Data](#)

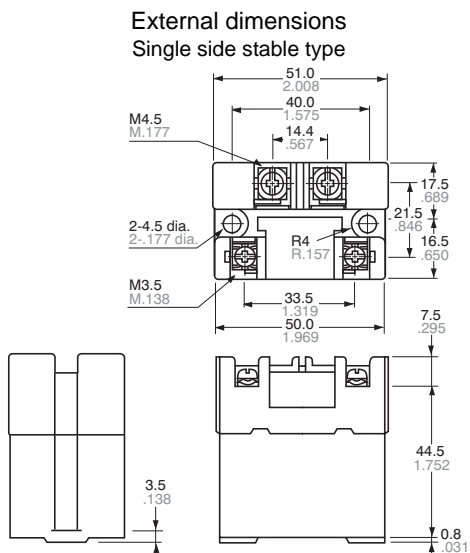

Schematic (Bottom view)
Single side stable type

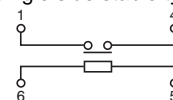

Panel cutout

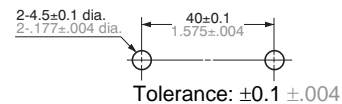

General tolerance: $\pm 0.3 \pm .012$

2 Form A [CAD Data](#)

External dimensions
Single side stable type

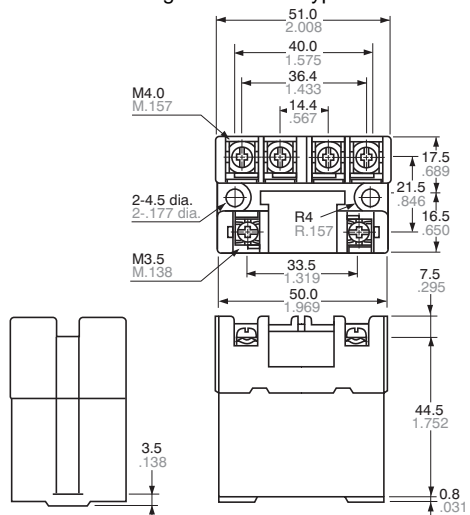

Schematic (Bottom view)
Single side stable type

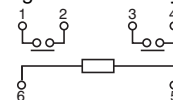

Panel cutout

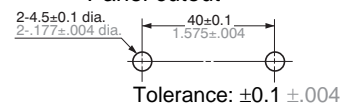

General tolerance: $\pm 0.3 \pm .012$

MOUNTING METHOD

1. Plug-in type

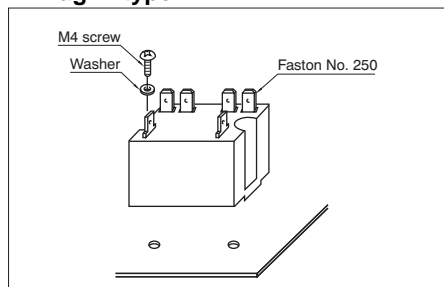

2. Screw terminal type

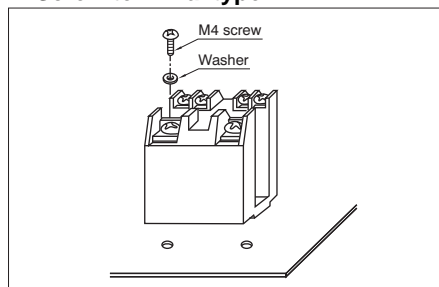

3. Allowable installation wiring size for screw terminal types and terminal sockets

Due to the UP terminals, it is possible to either directly connect the wires or use crimped terminal.

SAFETY STANDARDS

Item	UL/C-UL (Recognized)		CSA (Certified)		VDE (Certified)		TV rating (UL/CSA)		TÜV (Certified)	
	File No.	Contact rating	File No.	Contact rating	File No.	Contact rating	File No.	Rating	File No.	Rating
1 Form A	E43028	30A 277V AC 30A 30V DC 1.5HP 125V AC 3HP 250V AC	LR26550 etc.	30A 277V AC 30A 30V DC 1.5HP 125V AC 3HP 250V AC	4000668 1	30A 250V AC (cosφ=1.0) 30A 250V AC (cosφ=0.4) 5A 110V DC (0ms)	UL E43028	TV-15	B 09 04 13461 261	30A 250V AC (cosφ=1.0) 30A 250V AC (cosφ=0.4) 8A 110V DC (0ms)
2 Form A	E43028	25A 277V AC 25A 30V DC 1HP 125V AC 2HP 250V AC	LR26550 etc.	25A 277V AC 25A 30V DC 1HP 125V AC 2HP 250V AC	4000668 1	25A 250V AC (cosφ=1.0) 25A 250V AC (cosφ=0.4) 5A 110V DC (0ms)	UL E43028	TV-10	B 09 04 13461 261	25A 250V AC (cosφ=1.0) 25A 250V AC (cosφ=0.4) 8A 110V DC (0ms)

NOTES

- The dust cover should not be removed since doing so may alter the characteristics.
- Avoid use under severe environmental conditions, such as high humidity, organic gas or in dust, oily locations and locations subjected to extremely frequent shock or vibrations.
- When mounting, use spring washers. Optimum fastening torque ranges from 49 to 68.6 N·m (5 to 7 kgf·cm).
- Firmly insert the receptacles so that there is no slack or looseness. To remove a receptacle, 19.6 to 39.2 N (2 to 4 kg) of pulling strength is required. Do not remove more than one receptacle at one time. Always remove one receptacle at a time and pull it straight outwards.
- When using the AC type, the operate time due to the in-rush phase is 20 ms or more. Therefore, it is necessary for you to verify the characteristics for your actual circuit.
- When using the push-on blocks for the screw terminal type, use crimped terminals and tighten the screw-down terminals to the torque below.
M4.5 screw:
147 to 166.6 N·cm (15 to 17 kgf·cm)
M4 screw:
117.6 to 137 N·cm (12 to 14 kgf·cm)
M3.5 screw:
78.4 to 98 N·cm (8 to 10 kgf·cm)

For Cautions for Use, see [Relay Technical Information](#).

**Ideal for Solar inverter
Compact size, 1 Form A 48A
Power Relay**

HE RELAYS PV Type



FEATURES

- **48 A current at 250 V AC achieved in compact size (L: 33 × W: 38 × H: 36.3 mm L: 1.299 × W: 1.496 × H: 1.429 inch)**
Due to improved conduction efficiency, wide terminal blades are used.

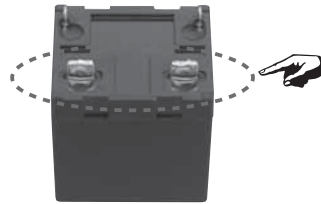

- **High insulation and 10,000 V surge breakdown voltage (between contacts and coil) achieved.**
- **Conforms to various safety standards**
UL, C-UL and VDE

TYPICAL APPLICATIONS

- **Photovoltaic power generation systems (Solar inverter)**

- **Contact gap: 2.5 mm (VDE0126 compliant)**

Compliant with European photovoltaic standard VDE0126
Compliant with EN61810-1 2.5 kV surge voltage (between contacts)

- **Contributes to energy saving in devices thanks to reduced coil hold voltage**

Coil hold voltage can be reduced down to 40% of the nominal coil voltage (ambient temperature 20°C 68°F). This equals to power consumption of approximately 310 mW.

*Coil hold voltage is the coil voltage after 100 ms following application of the nominal coil voltage.

ORDERING INFORMATION

HE 1a N - P - DC [] - Y5

Contact arrangement

1a: 1 Form A (Single side stable type)

Pick-up voltage

N: 70% of nominal voltage

Terminals

P: Blade terminal type

Coil voltage (DC)

6, 9, 12, 24V

Type, contact material and switching capacity

Y5: PV type, AgNi type and 1 Form A 48A

Note: UL/C-UL and VDE approved type is standard.

TYPES

Nominal coil voltage	Part No.
6V DC	HE1aN-P-DC6V-Y5
9V DC	HE1aN-P-DC9V-Y5
12V DC	HE1aN-P-DC12V-Y5
24V DC	HE1aN-P-DC24V-Y5

Standard packing: Carton: 20 pcs.; Case: 100 pcs.

RATING

1. Coil data

Nominal coil voltage	Pick-up voltage (at 20°C 68°F) (Initial)	Drop-out voltage (at 20°C 68°F) (Initial)	Nominal operating current [$\pm 10\%$] (at 20°C 68°F)	Coil resistance [$\pm 10\%$] (at 20°C 68°F)	Nominal operating power	Max. applied voltage (at 20°C 68°F)
6V DC	70%V or less of nominal voltage	10%V or more of nominal voltage	320mA	18.8 Ω	1,920mW	110%V of nominal voltage
9V DC			213mA	42.2 Ω		
12V DC			160mA	75.0 Ω		
24V DC			80mA	300.0 Ω		

2. Specifications

Characteristics	Item	Specifications	
Contact	Arrangement	1 Form A	
	Contact resistance (Initial)	Max. 100 m Ω (By voltage drop 6 V DC 1A)	
	Contact material	AgNi type	
Rating	Nominal switching capacity	48 A 250 V AC (resistive load)	
	Contact carrying power	12,000 VA (resistive load)	
	Max. switching voltage	250 V AC	
	Max. switching current	48 A (AC)	
	Nominal operating power	1,920 mW	
	Min. switching capacity (Reference value)*1	100 mA 5 V DC	
Electrical characteristics	Insulation resistance (Initial)	Min. 1,000M Ω (at 500V DC) Measurement at same location as "Breakdown voltage" section.	
	Breakdown voltage (Initial)	Between open contacts	2,000 Vrms for 1 min. (Detection current: 10 mA)
		Between contact and coil	5,000 Vrms for 1 min. (Detection current: 10 mA)
	Surge breakdown voltage*2 (Between contact and coil)	10,000 V (initial)	
	Temperature rise	Max. 60°C 140°F (By resistive method, contact carrying current: 48A, 100%V of nominal coil voltage at 55°C 131°F.) Max. 30°C 86°F (By resistive method, contact carrying current: 48A, 60%V of nominal coil voltage at 85°C 185°F.)	
	Coil hold voltage*3	40 to 100%V (Contact carrying current: 48A, at 20°C 68°F), 50 to 100%V (Contact carrying current: 48A, at 55°C 131°F), 50 to 60%V (Contact carrying current: 48A, at 85°C 185°F)	
	Operate time (at 20°C 68°F)	Max. 30 ms (nominal coil voltage, excluding contact bounce time)	
Release time (at 20°C 68°F)*5	Max. 10 ms (nominal coil voltage, excluding contact bounce time) (without diode)		
Mechanical characteristics	Shock resistance	Functional	Min. 98 m/s ² (Half-wave pulse of sine wave: 11 ms; detection time: 10 μ s.)
		Destructive	Min. 980 m/s ² (Half-wave pulse of sine wave: 6 ms.)
	Vibration resistance	Functional	10 to 55 Hz at double amplitude of 1.0 mm (Detection time: 10 μ s.)
		Destructive	10 to 55 Hz at double amplitude of 1.5 mm
Expected life	Mechanical	Min. 10 ⁶ (at 180 cpm)	
	Electrical	Resistive load	Min. 3 $\times 10^4$ (48 A 250 V AC) (ON : OFF = 1s : 9s)
		Inductive load	Endurance: 48 A 250 V AC (cos ϕ = 0.8), Min. 3 $\times 10^4$ (ON : OFF = 0.1s : 10s) Overload: 72 A 250 V AC (cos ϕ = 0.8), Min. 50 (ON : OFF = 0.1s : 10s)
Conditions	Conditions for operation, transport and storage*4	Ambient temperature: -50 to +55°C -58 to +131°F (When nominal coil voltage applied) -50 to +85°C -58 to +185°F (When applied coil hold voltage is 50% to 60% of nominal coil voltage) Humidity: 5 to 85% R.H. (Not freezing and condensing at low temperature); Atmospheric pressure: 86 to 106 kPa	
	Max. operating speed	6 cpm (at nominal switching capacity ON : OFF = 1s : 9s)	
Unit weight		Approx. 80 g 2.82 oz	

Notes:

- *1. This value can change due to the switching frequency, environmental conditions, and desired reliability level, therefore it is recommended to check this with the actual load.
- *2. Wave is standard shock voltage of $\pm 1.2 \times 50 \mu$ s according to JEC-212-1981
- *3. Coil hold voltage is the coil voltage after 100 ms following application of the nominal coil voltage.
- *4. The upper operation ambient temperature limit is the maximum temperature that can satisfy the coil temperature rise value. Refer to usage, transport and storage conditions in NOTES on page 12.
- *5. Release time will lengthen if a diode, etc., is connected in parallel to the coil. Be sure to verify operation under actual conditions.

REFERENCE DATA

1. Coil temperature rise

Sample: HE1aN-P-DC9V-Y5, 6 pcs.

Point measured: coil inside

Ambient temperature: 25°C 77°F, 60°C 140°F, 85°C 185°F

Contact carrying current: 48A

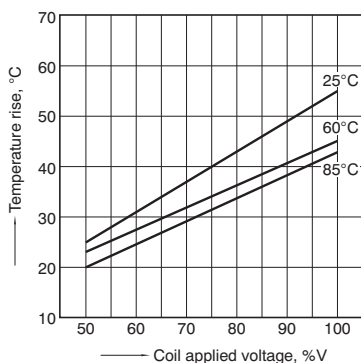

2. Electrical life test (Resistive load 250V AC, 48A at 85°C 185°F)

Sample: HE1aN-P-DC9V-Y5, 6 pcs.

Operation frequency: 6 times/min.

(ON/OFF = 1.0s : 9.0s)

Circuit:

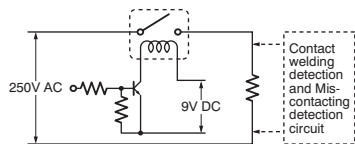

Change of pick-up and drop-out voltage

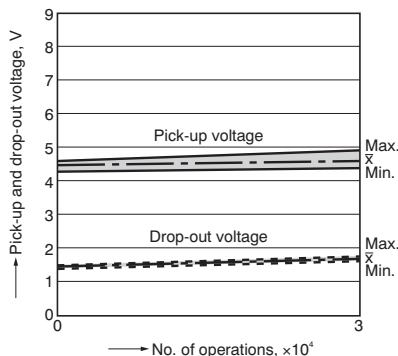

Change of contact resistance

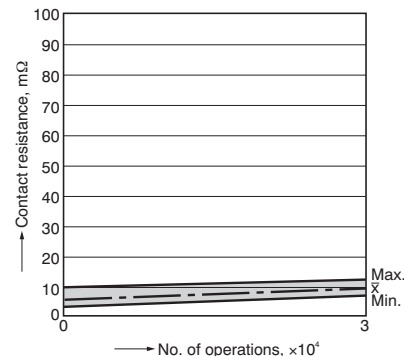

DIMENSIONS (Unit: mm inch)



External dimensions

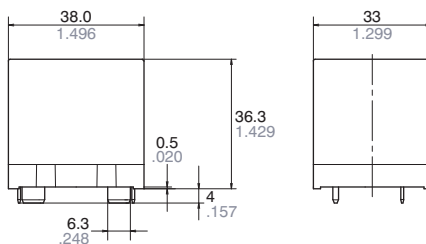

General tolerance: $\pm 0.3 \pm 0.12$

PC board pattern (Bottom view)

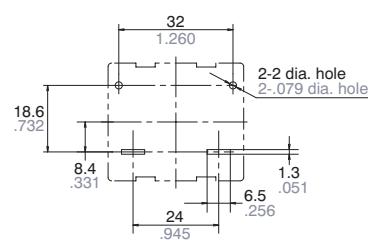

Tolerance: $\pm 0.1 \pm 0.004$

SAFETY STANDARDS

Certification authority		
High capacity type	C-UL	48 A 277 V AC (at 85°C 185°F)
	VDE (VDE0435)	48 A 250 V AC $\cos\phi = 0.8$ (at 85°C 185°F)
Standard type	UL, CSA	35 A 277 V AC (at 25°C 77°F)
	VDE (VDE0435)	35 A 250 V AC $\cos\phi = 1$ (at 80°C 176°F)

NOTES

■ Usage, transport and storage conditions

1) Temperature:

–50 to +55°C –58 to +131°F

–50 to +85°C –58 to +185°F (When applied coil hold voltage is 50% to 60% of nominal coil voltage)

2) Humidity: 5 to 85% RH

(Avoid freezing and condensation.)

The humidity range varies with the temperature. Use within the range indicated in the graph below.

3) Atmospheric pressure: 86 to 106 kPa

Temperature and humidity range for usage, transport, and storage

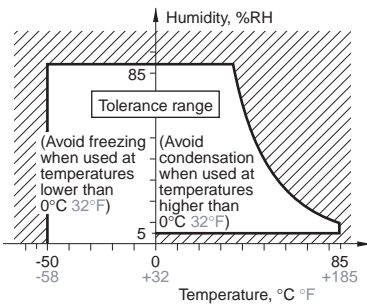
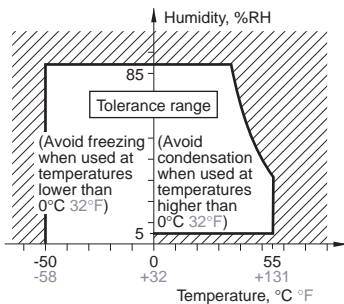

* –50 to +85°C –58 to +185°F (When applied coil hold voltage is 50% to 60% of nominal coil voltage)

4) Condensation

Condensation forms when there is a sudden change in temperature under high temperature and high humidity conditions. Condensation will cause deterioration of the relay insulation.

5) Freezing

Condensation or other moisture may freeze on the relay when the temperatures is lower than 0°C 32°F.

This causes problems such as sticking of movable parts or operational time lags.

6) Low temperature, low humidity environments

The plastic becomes brittle if the relay is exposed to a low temperature, low humidity environment for long periods of time.

■ Certification

This relay is C-UL certified.

48 A 277 V AC

This relay is certified by VDE as an electromagnetic relay that complies with VDE0435.

48 A 250 V AC $\cos\phi = 0.8$

■ Others

1) For precautions regarding use and explanations of technical terminology, please refer to our web site.

(panasonic-electric-works.net/ac)

2) To ensure good operation, please keep the voltage on the coil ends to $\pm 5\%$ (at 20°C 68°F) of the rated coil operation voltage. Also, please be aware that the pick-up voltage and drop-out voltage may change depending on the temperature and conditions of use.

3) Keep the ripple rate of the nominal coil voltage below 5%.

4) The cycle lifetime is defined under the standard test condition specified in the JIS C 5442 standard (temperature 15 to 35°C 59 to 95°F, humidity 25 to 85%).

Check this with the real device as it is affected by coil driving circuit, load type, activation frequency, activation phase, ambient conditions and other factors.

Also, be especially careful of loads such as those listed below.

(1) When used for AC load-operating and the operating phase is synchronous.

Rocking and fusing can easily occur due to contact shifting.

(2) Highly frequent load-operating

When highly frequent opening and closing of the relay is performed with a load that causes arcs at the contacts, nitrogen and oxygen in the air is fused by the arc energy and HNO_3 is formed. This can corrode metal materials.

Three countermeasures for these are listed here.

- Incorporate an arc-extinguishing circuit.
- Lower the operating frequency
- Lower the ambient humidity

5) This value can change due to the switching frequency, environmental conditions, and desired reliability level, therefore it is recommended to check this with the actual load.

6) Heat, smoke, and even a fire may occur if the relay is used in conditions outside of the allowable ranges for the coil ratings, contact ratings, operating cycle lifetime, and other specifications. Therefore, do not use the relay if these ratings are exceeded.

7) If the relay has been dropped, the appearance and characteristics should always be checked before use.

8) Incorrect wiring may cause unexpected events or the generation of heat or flames.

ACCESSORIES
(Terminal sockets)

HE RELAY
ACCESSORIES

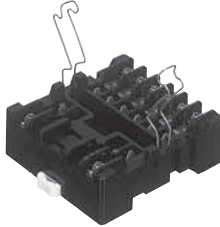

FEATURES

- 1. Snap-in mounting to DIN rails is possible.**
Can be inserted into 35 mm wide DIN rails. Removal is easy, too.
- 2. Sure and easy wiring**
The use of UP terminals makes wiring exceptionally easy and sure.

- 3. Hold-down clips can be stored in main unit**
Because the hold-down clips can be stored in the main unit, there is no need to remove them when, for example, wiring is changed.

TYPES

No. of poles	Types	Part No.	Packing quantity	
			Carton	Case
For 1 Form A	Single side stable type	JH1-SF	10 pcs.	50 pcs.
For 2 Form A	Single side stable type	JH2-SF	10 pcs.	50 pcs.

SPECIFICATIONS

Item	Specifications	
Arrangement	1 Form A	2 Form A
Max. continuous current	30A 250V AC	20A 250V AC
Breakdown voltage (initial)	2,000 Vrms for 1min (between terminals) (Detection current: 10mA.)	
Insulation resistance	Min. 100MΩ (between poles)	
Heat resistance	150°C ±3°C for 1 hour	

DIMENSIONS (Unit: mm inch)

1 Form A and 2 Form A types

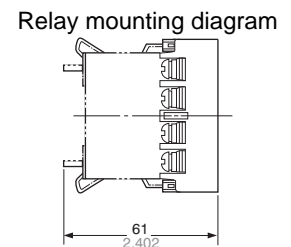
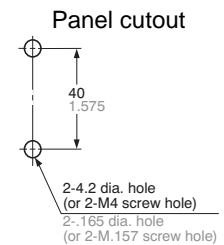
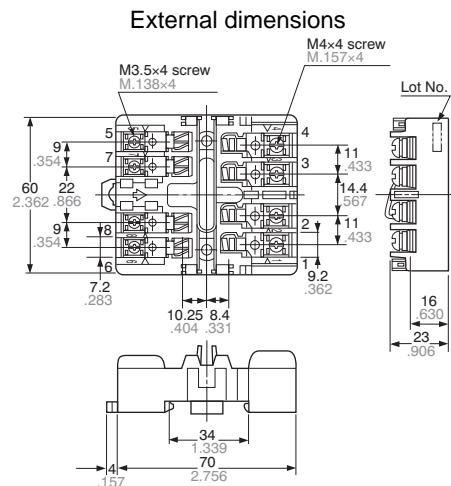

Note: The JH1-SF (1 Form A single side stable type) does not have receptacles (tooth rests) for numbers 2, 3, 7, and 8.
The JH2-SF (2 Form A single side stable type) does not have receptacles (tooth rests) for numbers 7 and 8.

MOUNTING METHOD

1. Relay mounting

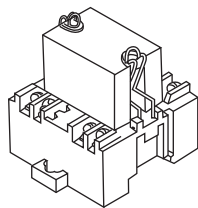

2. Installing to a DIN rail

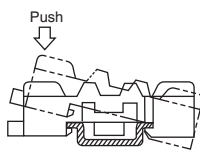

3. Removing from a DIN rail

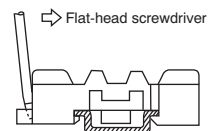

NOTES

1. Be careful not to drop the relay. It is made of heat-hardened resin and may break.

2. Be sure to tighten the screw-down terminals firmly. Loose terminals may lead to the generation of heat.

3. When the 1 Form A is used in situations covered by the Japanese Electrical Appliance and Material Control Law, the use of 5.5 mm² cabling and 30 A current is not allowed. Consequently, the circuit should be less than 20 A.

4. When fixing the terminal socket with screws, to avoid torque damage and distortion, apply torque within the ranges shown below.

M3.5 screws:

0.784 to 0.98 N·m (8 to 10 kgf·cm)

M4 screws:

1.176 to 1.37 N·m (12 to 14 kgf·cm)