

## High-feed milling cutter

For indexable milling inserts: XCNT 120520..

**ATORN®**

### Application

Dramatically increase your productivity and make great cost-savings – with the high-feed milling cutters. The unique cutting geometries provide extremely smooth running and low cutting forces at maximum feed rates. Our extensive program offers solutions for a wide range of applications in modern machine tools, whether in die and mould making or in general mechanical engineering.

### Execution

- Wear-resistant, nickel-plated version
- Robust supports
- With internal cooling
- Variable pitch
- Tightening torque (indexable insert) M3.5 = 3.5 Nm

### Advantage

- Broad range of application
- Minimum-vibration milling even for long mounting lengths
- Optimum roughing tool
- Tooth feed possible up to 3 mm
- Reduces production times

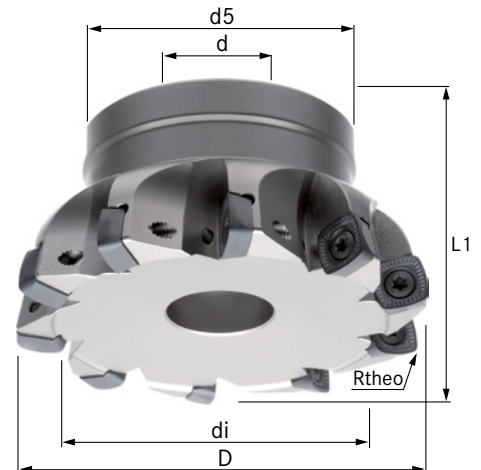

<b>Art. No.</b>	<b>16026 268</b>
<b>Max. cutting edge diameter</b>	66 mm
<b>Min. cutting edge diameter</b>	47.1 mm
<b>Length</b>	50 mm
<b>Bore diameter</b>	27 mm
<b>Radius, theoretical</b>	3.5 mm
<b>max. ap</b>	1.5 mm
<b>Number of cutting edges</b>	5 PCS
<b>Suitable indexable insert no.</b>	3

### EAN-Code

4050293405668