

Slim Power Relays

RJ Series



Compact and rugged power relays. Large switching capacity.

Plug-in terminal relays ideal for various applications such as control panels and machine tools.



- See website for details on approvals and standards.
- Lloyd Register type approved.

Large Switching Capacity

Highly conductive materials ensure stable electric conduction of current.

Large Switching Capacity (maximum allowable switching current)

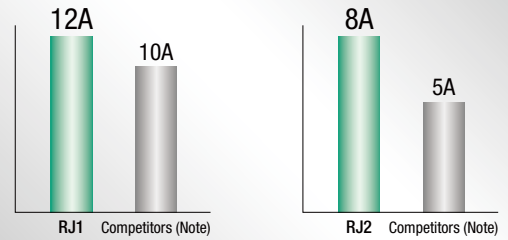

Note: According to published specifications in other manufacturers' catalogs.

Excellent Durability

Our unique return spring structure provides improved durability and reliability of all mechanical parts.

Long Mechanical Life

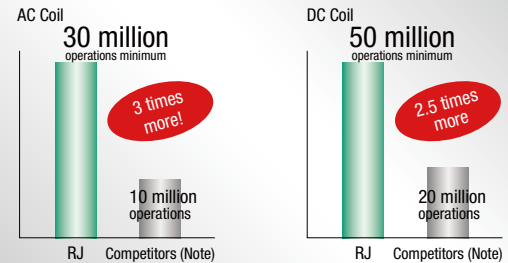

Note: According to published specifications in other manufacturers' catalogs.

High Visibility LED Indicator

IDEC's Unique Light Guide Structure.

An RJ relay can be easily identified with the illuminating LED.

IEC-compliant Green Indication.

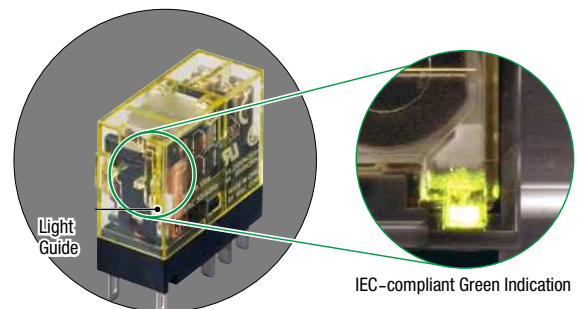

Wide variety of models

Diode, reverse polarity diode, and RC circuits are available.

Wide variety of AC/DC coil voltages.

RJ series Slim Power Relays

Plug-in Terminal

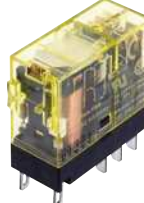
Shape	 					
	1-pole: With forward polarity diode (with LED indicator)		2-pole: Standard (with LED Indicator)			
Style	1-pole (SPDT)		2-pole (DPDT)			
	Part No.	Code: □	Part No.	Code: □		
Standard (with LED Indicator)	RJ1S-CL-□	A12, A24, A100, A110 A200, A220	RJ2S-CL-□	A12, A24, A100, A110 A200, A220		
		D5, D6, D12, D24, D48 D100			D5, D6, D12, D24, D48 D100	
Simple (without LED Indicator)		RJ1S-C-□		A12, A24, A100, A110 A200, A220	RJ2S-C-□	A12, A24, A100, A110 A200, A220
	D5, D6, D12, D24, D48 D100			D5, D6, D12, D24, D48 D100		
With forward polarity diode (with LED indicator)	RJ1S-CLD-□		D5, D6, D12, D24, D48 D100	RJ2S-CLD-□		D5, D6, D12, D24, D48 D100
With forward polarity diode (without LED indicator)		RJ1S-CD-□	D5, D6, D12, D24, D48 D100		RJ2S-CD-□	D5, D6, D12, D24, D48 D100
With reverse polarity diode (with LED indicator)			RJ1S-CLD1-□			D5, D6, D12, D24, D48 D100
With reverse polarity diode (without LED indicator)	RJ1S-CD1-□			D5, D6, D12, D24, D48 D100		RJ2S-CD1-□
With RC (with LED indicator)		RJ1S-CLR-□		A12, A24, A100, A110 A200, A220	RJ2S-CLR-□	
With RC (without LED indicator)			RJ1S-CR-□	A12, A24, A100, A110 A200, A220		

• Other coil voltages available (A115, A120, A230, A240)

Coil Voltage Code *

Code	Rated Coil Voltage
A12	12V AC
A24	24V AC
A100	100-(110)V AC
A110	110V AC
A115	115V AC
A120	120V AC
A200	200-(220)V AC
A220	220V AC
A230	230V AC
A240	240V AC
D5	5V DC
D6	6V DC
D12	12V DC
D24	24V DC
D48	48V DC
D100	100-110V DC

Note: Specify a coil voltage code in place of □ in the Part No.

Contact Ratings

No. of Poles	Contact	Allowable Contact Power		Rated Load			Allowable Switching Current	Allowable Switching Voltage	Minimum Applicable Load (Note)
		Resistive Load	Inductive Load	Voltage	Resistive Load	Inductive Load cos φ = 0.3 L/R = 7 ms			
1	NO	3000VA AC 360W DC	1875VA AC 180W DC	250V AC	12A	7.5A	12A	250V AC 125V DC	5V DC, 100 mA (reference value)
				30V DC	12A	6A			
	NC	3000VA AC 180W DC	1875VA AC 90W DC	250V AC	12A	7.5A			
				30V DC	6A	3A			
2	NO	2000VA AC 240W DC	1000VA AC 120W DC	250V AC	8A	4A	8A	250V AC 125V DC	5V DC, 10 mA (reference value)
				30V DC	8A	4A			
	NC	2000VA AC 120W DC	1000VA AC 60W DC	250V AC	8A	4A			
				30V DC	4A	2A			

Note: Measured at operating frequency of 120 operations per minute. Failure rate level P.

Approved Ratings

Voltage	UL				CSA								VDE			
	Resistive				Resistive				Inductive				Resistive		AC-15, DC-13 (Note)	
	RJ1		RJ2		RJ1		RJ2		RJ1		RJ2		RJ1	RJ2	RJ1	RJ2
	NO	NC	NO	NC	NO	NC	NO	NC	NO	NC	NO	NC	NO	NO	NO	NO
250V AC	12A	12A	8A	8A	12A	12A	8A	8A	7.5A	7.5A	4A	4A	12A	8A	6A	3A
30V DC	12A	6A	8A	4A	12A	6A	8A	4A	6A	3A	4A	2A	12A	8A	2.5A	2A

Note: According to the utilization categories of IEC60947-5-1

- APEM
- Switches & Pilot Lights
- Control Boxes
- Emergency Stop Switches
- Enabling Switches
- Safety Products
- Explosion Proof
- Terminal Blocks
- Relays & Sockets
- Circuit Protectors
- Power Supplies
- LED Illumination
- Controllers
- Operator Interfaces
- Sensors
- AUTO-ID

- Relays
- Sockets
- DIN Rail Products

- RJ
- RU
- RV8H
- RL

RJ Series Slim Power Relays

Coil Ratings

Rated Voltage	Coil Voltage Code	Without LED Indicator			With LED Indicator			Operating Characteristics (against rated values at 20°C)			Power Consumption	
		Rated Current (mA) ±15% (at 20°C)		Coil Resistance (Ω) ±10% (at 20°C)	Rated Current (mA) ±15% (at 20°C)		Coil Resistance (Ω) ±10% (at 20°C)	Minimum Pickup Voltage	Dropout Voltage	Maximum Allowable Voltage (Note)		
		50 Hz	60 Hz		50 Hz	60 Hz						
AC 50/60 Hz	12V AC	A12	87.3	75.0	62.5	91.1	78.8	62.5	80% maximum	30% minimum	140%	Approx. 0.9 VA (60Hz)
	24V AC	A24	43.9	37.5	243	47.5	41.1	243				
	110V AC	A110	9.6	8.2	5270	9.5	8.1	5270				
	115V AC	A115	9.1	7.8	6030	9.0	7.7	6030				
	120V AC	A120	8.8	7.5	6400	8.7	7.4	6400				
	220V AC	A220	4.8	4.1	21530	4.8	4.1	21530				
	230V AC	A230	4.6	3.9	24100	4.6	3.9	24100				
	240V AC	A240	4.3	3.7	25570	4.3	3.7	25570				
DC	5V	D5	106		47.2		110		70% maximum	10% minimum	170%	Approx. 0.53W
	6V	D6	88.3		67.9		92.2					
	12V	D12	44.2		271		48.0					
	24V	D24	22.1		1080		25.7					
	48V	D48	11.0		4340		10.7					
	100-110V	D100	5.3-5.8		18870		5.2-5.7					

Note: Maximum allowable voltage is the maximum voltage that can be applied to relay coils and not the continuous allowable voltage.

Specifications

Model	RJ1S		RJ2S	
Number of Poles	1-pole		2-pole	
Contact Configuration	SPDT		DPDT	
Contact Material	Silver-nickel alloy			
Degree of Protection	IP40			
Contact Resistance (initial value) (*1)	50 mΩ maximum			
Operate Time (*2)	15 ms maximum			
Release Time (*2)	10 ms maximum (with diode/with RC: 20 ms maximum)			
Dielectric Strength	Between contact and coil	5000V AC, 1 minute		5000V AC, 1 minute
	Between contacts of the same pole	1000V AC, 1 minute		1000V AC, 1 minute
	Between contacts of different poles	—		3000V AC, 1 minute
Vibration Resistance	Operating extremes	10 to 55 Hz, amplitude 0.75 mm		
	Damage limits	10 to 55 Hz, amplitude 0.75 mm		
Shock Resistance	Operating extremes	NO contact: 200 m/s ² , NC contact: 100 m/s ²		
	Damage limits	1000 m/s ²		
Electrical Life (rated load)	AC load: 200,000 operations minimum (operation frequency 1800 operations per hour) DC load: 100,000 operations minimum (operation frequency 1800 operations per hour)			
Mechanical Life (no load)	AC coil: 30,000,000 operations minimum (operation frequency 18,000 operations per hour) DC coil: 50,000,000 operations minimum (operation frequency 18,000 operations per hour)			
Operating Temperature (*3)	-40 to +70°C (no freezing)			
Operating Humidity	5 to 85% RH (no condensation)			
Weight (approx.)	19g			

Note: Above values are initial values.

*1) Measured using 5V DC, 1A voltage drop method.

*2) Measured at the rated voltage (at 20°C), excluding contact bounce time.

*3) 100% rated voltage.

Applicable Socket

Terminal	Part No.		Page
	RJ1S (1-pole)	RJ2S (2-pole)	
Standard Screw Terminal	SJ1S-05B	SJ2S-05B	H-043
Finger-safe Screw Terminal	SJ1S-07L	SJ2S-07L	
Push-in Terminal	SJ1S-21L	SJ2S-21L	

Relay Coil Tape Color

Coil Voltage	Coil Color
12V AC	Yellow
24V AC	White
110V AC	Clear
115V	Yellow
120V AC	Blue
220V AC	Black
230V AC	Yellow
240V AC	Red
5V DC	Yellow
6V DC	Yellow
12V DC	Yellow
24V DC	Green
48V DC	Yellow
100-110V DC	Yellow

Dimensions

RJ1S

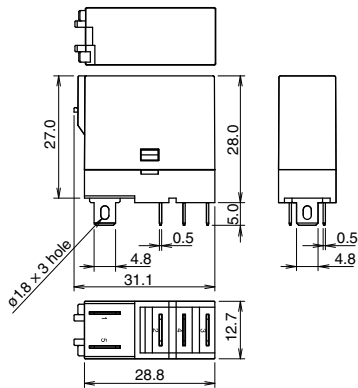

RJ2S-CL

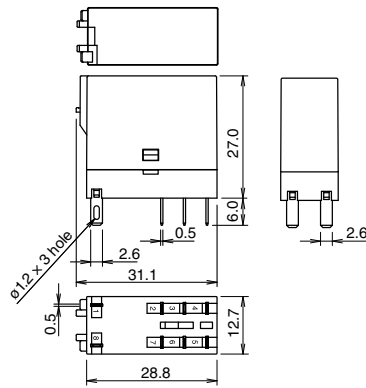

All dimensions in mm.

RJ1S-CL-□ Standard (w/LED Indicator)

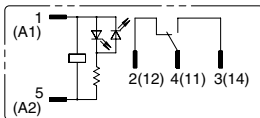

Coil voltage 24V AC/DC and below

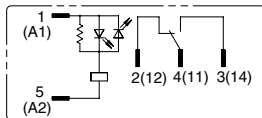

Coil voltage greater than 24V AC/DC

RJ2S-CL-□ Standard (w/LED Indicator)

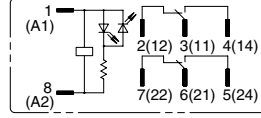

Coil voltage 24V AC/DC and below

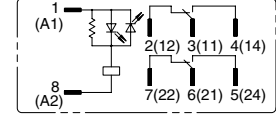

Coil voltage greater than 24V AC/DC

RJ1S-C-□ Simple

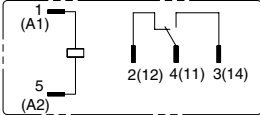

RJ2S-C-□ Simple

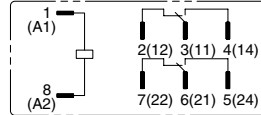

RJ1S-CLD-□ With Diode (w/LED Indicator)

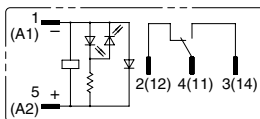

Coil voltage 24V DC and below

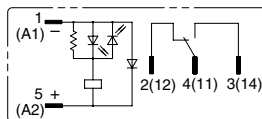

Coil voltage greater than 24V DC

RJ2S-CLD-□ With Diode (w/LED Indicator)

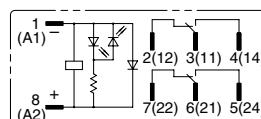

Coil voltage 24V DC and below

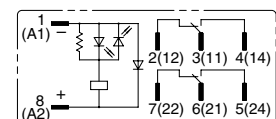

Coil voltage greater than 24V DC

RJ1S-CD-□ With Diode

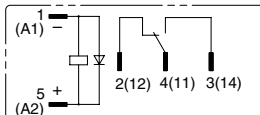

RJ2S-CD-□ With Diode

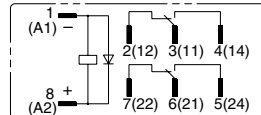

RJ1S-CLD1-□ With Diode (w/LED Indicator)

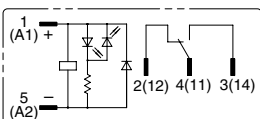

Coil voltage 24V DC and below

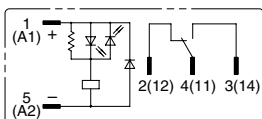

Coil Voltage greater than 24V DC

RJ2S-CLD1-□ With Diode (w/LED Indicator)

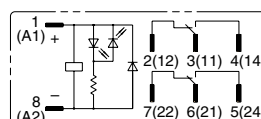

Coil voltage 24V DC and below

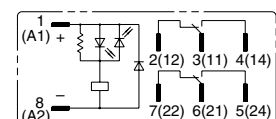

Coil voltage greater than 24V DC

RJ1S-CD1-□ With Diode

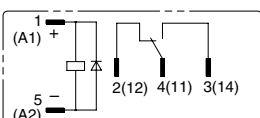

RJ2S-CD1-□ With Diode

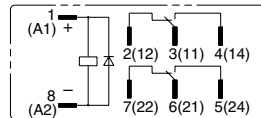

RJ1S-CLR-□ With RC (w/LED Indicator)

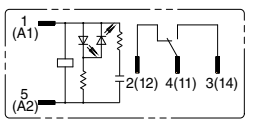

Coil voltage 24V AC and below

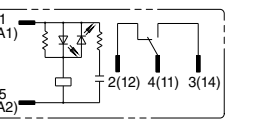

Coil voltage greater than 24V AC

RJ2S-CLR-□ With RC (w/LED Indicator)

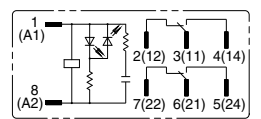

Coil voltage 24V AC and below

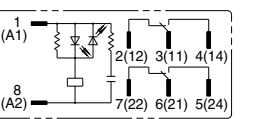

Coil voltage greater than 24V AC

RJ1S-CR-□ With RC

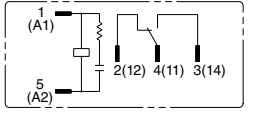

RJ2S-CR-□ With RC

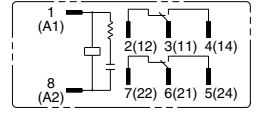

APEM

Switches & Pilot Lights

Control Boxes

Emergency Stop Switches

Enabling Switches

Safety Products

Explosion Proof

Terminal Blocks

Relays & Sockets

Circuit Protectors

Power Supplies

LED Illumination

Controllers

Operator Interfaces

Sensors

AUTO-ID

Relays

Sockets

DIN Rail Products

RJ

RU

RV8H

RL

RJ Series Slim Power Relays

Electrical Life Curve

RJ1

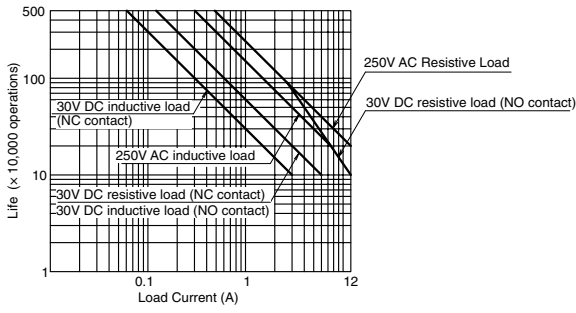

RJ2

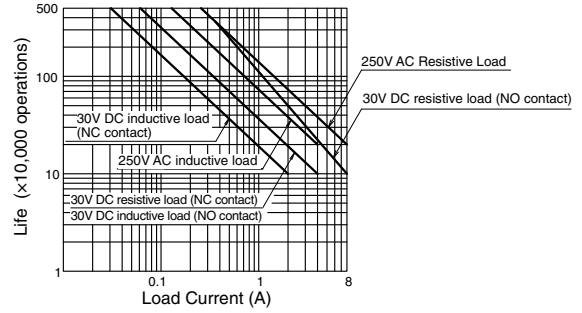

Maximum Switching Capacity

RJ1

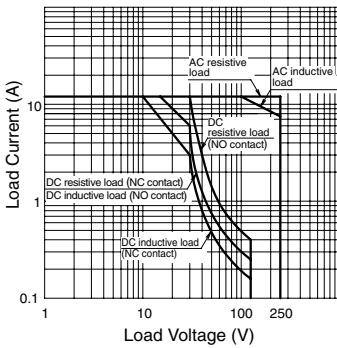

RJ2

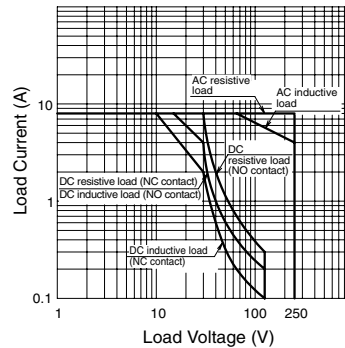

Operating Temperature and Coil Temperature Rise

RJ1

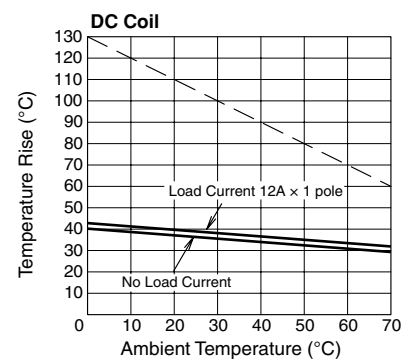
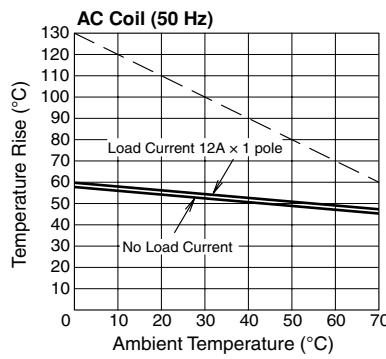
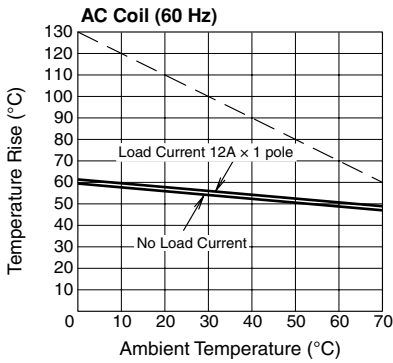

RJ2

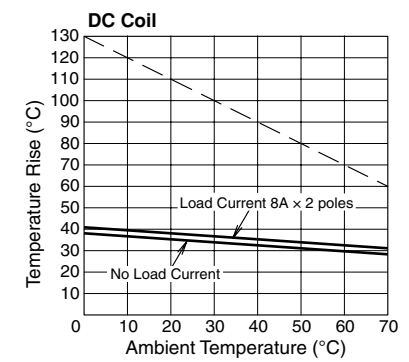
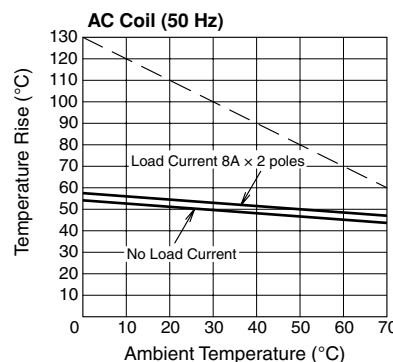
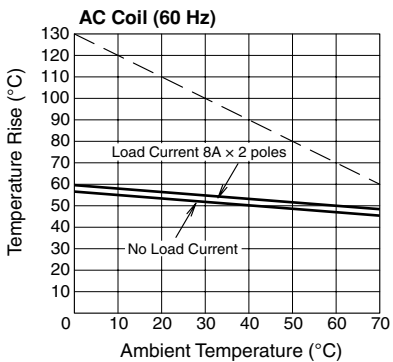

The above temperature rise curves show characteristics when 100% the rated coil voltage is applied.
The slanted dashed line indicates allowable temperature rise for the coil at different ambient temperatures.

- APEM
- Switches & Pilot Lights
- Control Boxes
- Emergency Stop Switches
- Enabling Switches
- Safety Products
- Explosion Proof
- Terminal Blocks
- Relays & Sockets
- Circuit Protectors
- Power Supplies
- LED Illumination
- Controllers
- Operator Interfaces
- Sensors
- AUTO-ID

- Relays
- Sockets
- DIN Rail Products
- RJ
- RU
- RV8H
- RL

⚠ Safety Precautions

Turn off the power to the relay before starting installation, removal, wiring, maintenance, and inspection of the relays. Failure to turn power off may cause electrical shock or fire hazard. Observe specifications and rated values, otherwise electrical shock or fire hazard may be caused. Use wires of the proper size to meet the voltage and current

requirements. Tighten the terminal screws on the relay socket to the proper tightening torque.

Instructions

Driving Circuit for Relays

1. To make sure of correct relay operation, apply rated voltage to the relay coil.
2. Input voltage for the DC coil:
A complete DC voltage is best for the coil power to make sure of stable relay operation. When using a power supply containing a ripple voltage, suppress the ripple factor within 5%. When power is supplied through a rectification circuit, the relay operating characteristics, such as pickup voltage and dropout voltage, depend on the ripple factor. Connect a smoothing capacitor for better operating characteristics as shown below.

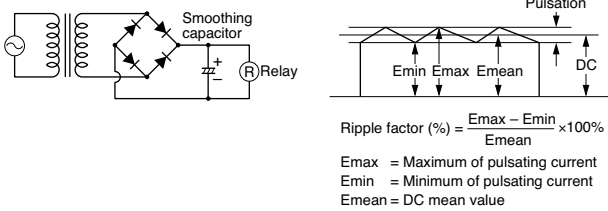

3. Operating the relay in synchronism with AC load:
If the relay operates in synchronism with the AC power voltage of the load, the relay life may be reduced. If this is the case, select a relay in consideration of the required reliability for the load. Or, make the relay turn on and off irrespective of the AC power phase or near the point where the AC phase crosses zero voltage.

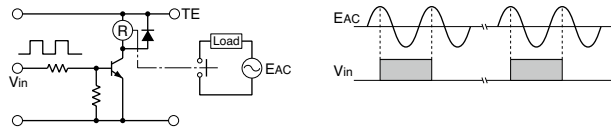

4. Leakage current while relay is off:
When driving an element at the same time as the relay operation, a special consideration is needed for the circuit design. As shown in the incorrect circuit below, Leakage current (I_o) flows through the relay coil while the relay is off. Leakage current causes the coil release failure or adversely affects the vibration resistance and shock resistance. Design a circuit as shown in the correct example.

Incorrect

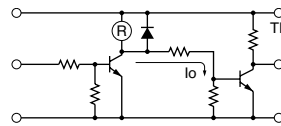

Correct

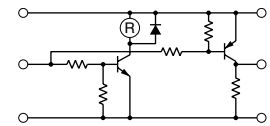

5. Surge suppression for transistor driving circuits:
When the relay coil is turned off, a high-voltage pulse is generated, causing the transistor to deteriorate and sometimes to break. Be sure to connect a diode to suppress the counter electromotive force. Then, the coil release time becomes slightly longer. To shorten the coil release time, connect a Zener diode between the collector and emitter of the transistor. Select a Zener diode with a Zener voltage slightly higher than the power voltage.

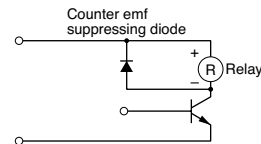

- APEM
- Switches & Pilot Lights
- Control Boxes
- Emergency Stop Switches
- Enabling Switches
- Safety Products
- Explosion Proof
- Terminal Blocks
- Relays & Sockets
- Circuit Protectors
- Power Supplies
- LED Illumination
- Controllers
- Operator Interfaces
- Sensors
- AUTO-ID

- Relays
- Sockets
- DIN Rail Products

- RJ
- RU
- RV8H
- RL

Instructions

Protection for Relay Contacts

- The contact ratings show maximum values. Make sure that these values are not exceeded. When an inrush current flows through the load, the contact may become welded. If this is the case, connect a contact protection circuit, such as a current limiting resistor.
- Contact protection circuit:
When switching an inductive load, arcing causes carbides to form on the contacts, resulting in an increased contact resistance. In consideration of contact reliability, contact life, and noise suppression, use of a surge absorbing circuit is recommended. Note that the release time of the load becomes slightly longer. Check the operation using the actual load. Incorrect use of a contact protection circuit will adversely affect switching characteristics. Four typical examples of contact protection circuits are shown in the following table:

RC		This protection circuit can be used when the load impedance is smaller than the RC impedance in an AC load power circuit. R: Resistor of approximately the same resistance value as the load C: 0.1 to 1 μF
		This protection circuit can be used for both AC and DC load power circuits. R: Resistor of approximately the same resistance value as the load C: 0.1 to 1 μF
Diode		This protection circuit can be used for DC load power circuits. Use a diode with the following ratings. Reverse withstand voltage: Power voltage of the load circuit × 10 Forward current: More than the load current
		This protection circuit can be used for both AC and DC load power circuits. For a best result, when using on a power voltage of 24 to 48V AC/DC, connect a varistor across the load. When using on a power voltage of 100 to 240V AC/DC, connect a varistor across the contacts.

- Do not use a contact protection circuit as shown below:

	This protection circuit is very effective in arc suppression when opening the contacts. But, the capacitor is charged while the contacts are opened. When the contacts are closed, the capacitor is discharged through the contacts, increasing the possibility of contact welding.
	This protection circuit is very effective in arc suppression when opening the contacts. But, when the contacts are closed, a current flows to charge the capacitor, causing contact welding.

Generally, switching a DC inductive load is more difficult than switching a DC resistive load. Using an appropriate arc suppressor, however, will improve the switching characteristics of a DC inductive load.

Other Precautions

- General notice:
 - To maintain the initial characteristics, do not drop the relay or shock the relay.
 - The relay cover cannot be removed from the base during normal operation. To maintain the initial characteristics, do not remove the relay cover.
 - Use the relay in environments free from condensation of dust, sulfur dioxide (SO₂), and hydrogen sulfide (H₂S).
 - Make sure that the coil voltage does not exceed the applicable coil voltage range.
- Connecting outputs to electronic circuits:
When the output is connected to a load which responds very quickly, such as an electronic circuit, contact bouncing causes incorrect operation of the load. Take the following measures into consideration.
 - Connect an integral circuit.
 - Suppress the pulse voltage due to bouncing within the noise margin of the load.
- UL- and CSA-approved ratings may differ from product rated values determined by IDEC.
- Do not use relays in the vicinity of strong magnetic field as this may affect relay operation.
 - DC diode type has polarity.
 - The surge absorbing element on AC relays with RC or DC relays with diode is provided to absorb the counter electromotive force generated by the coil. When the relay is subject to an excessive external surge voltage, the surge absorbing element may be damaged. Add another surge absorbing provision to the relay to prevent damage.

Ordering Terms and Conditions

Thank you for using IDEC Products.

By purchasing products listed in our catalogs, datasheets, and the like (hereinafter referred to as "Catalogs") you agree to be bound by these terms and conditions. Please read and agree to the terms and conditions before placing your order.

1. Notes on contents of Catalogs

- (1) Rated values, performance values, and specification values of IDEC products listed in this Catalog are values acquired under respective conditions in independent testing, and do not guarantee values gained in combined conditions.
Also, durability varies depending on the usage environment and usage conditions.
- (2) Reference data and reference values listed in Catalogs are for reference purposes only, and do not guarantee that the product will always operate appropriately in that range.
- (3) The specifications / appearance and accessories of IDEC products listed in Catalogs are subject to change or termination of sales without notice, for improvement or other reasons.
- (4) The content of Catalogs is subject to change without notice.

2. Note on applications

- (1) If using IDEC products in combination with other products, confirm the applicable laws / regulations and standards.
Also, confirm that IDEC products are compatible with your systems, machines, devices, and the like by using under the actual conditions. IDEC shall bear no liability whatsoever regarding the compatibility with IDEC products.
- (2) The usage examples and application examples listed in Catalogs are for reference purposes only. Therefore, when introducing a product, confirm the performance and safety of the instruments, devices, and the like before use. Furthermore, regarding these examples, IDEC does not grant license to use IDEC products to you, and IDEC offers no warranties regarding the ownership of intellectual property rights or non-infringement upon the intellectual property rights of third parties.
- (3) When using IDEC products, be cautious when implementing the following.
 - i. Use of IDEC products with sufficient allowance for rating and performance
 - ii. Safety design, including redundant design and malfunction prevention design that prevents other danger and damage even in the event that an IDEC product fails
 - iii. Wiring and installation that ensures the IDEC product used in your system, machine, device, or the like can perform and function according to its specifications
- (4) Continuing to use an IDEC product even after the performance has deteriorated can result in abnormal heat, smoke, fires, and the like due to insulation deterioration or the like. Perform periodic maintenance for IDEC products and the systems, machines, devices, and the like in which they are used.
- (5) IDEC products are developed and manufactured as general-purpose products for general industrial products. They are not intended for use in the following applications, and in the event that you use an IDEC product for these applications, unless otherwise agreed upon between you and IDEC, IDEC shall provide no guarantees whatsoever regarding IDEC products.
 - i. Use in applications that require a high degree of safety, including nuclear power control equipment, transportation equipment (railroads / airplanes / ships / vehicles / vehicle instruments, etc.), equipment for use in outer space, elevating equipment, medical instruments, safety devices, or any other equipment, instruments, or the like that could endanger life or human health
 - ii. Use in applications that require a high degree of reliability, such as provision systems for gas / waterworks / electricity, etc., systems that operate continuously for 24 hours, and settlement systems
 - iii. Use in applications where the product may be handled or used deviating from the specifications or conditions / environment listed in the Catalogs, such as equipment used outdoors or applications in environments subject to chemical pollution or electromagnetic interference
If you would like to use IDEC products in the above applications, be sure to consult with an IDEC sales representative.

3. Inspections

We ask that you implement inspections for IDEC products you purchase without delay, as well as thoroughly keep in mind management/maintenance regarding handling of the product before and during the inspection.

4. Warranty

- (1) Warranty period
The warranty period for IDEC products shall be one (1) year after purchase or delivery to the specified location. However, this shall not apply in cases where there is a different specification in the Catalogs or there is another agreement in place between you and IDEC.
- (2) Warranty scope
Should a failure occur in an IDEC product during the above warranty period for reasons attributable to IDEC, then IDEC shall replace or repair that product, free of charge, at the purchase location / delivery location of the product, or an IDEC service base. However, failures caused by the following reasons shall be deemed outside the scope of this warranty.
 - i. The product was handled or used deviating from the conditions / environment listed in the Catalogs
 - ii. The failure was caused by reasons other than an IDEC product
 - iii. Modification or repair was performed by a party other than IDEC
 - iv. The failure was caused by a software program of a party other than IDEC
 - v. The product was used outside of its original purpose
 - vi. Replacement of maintenance parts, installation of accessories, or the like was not performed properly in accordance with the user's manual and Catalogs
 - vii. The failure could not have been predicted with the scientific and technical standards at the time when the product was shipped from IDEC
 - viii. The failure was due to other causes not attributable to IDEC (including cases of force majeure such as natural disasters and other disasters)Furthermore, the warranty described here refers to a warranty on the IDEC product as a unit, and damages induced by the failure of an IDEC product are excluded from this warranty.

5. Limitation of liability

The warranty listed in this Agreement is the full and complete warranty for IDEC products, and IDEC shall bear no liability whatsoever regarding special damages, indirect damages, incidental damages, or passive damages that occurred due to an IDEC product.

6. Service scope

The prices of IDEC products do not include the cost of services, such as dispatching technicians. Therefore, separate fees are required in the following cases.

- (1) Instructions for installation / adjustment and accompaniment at test operation (including creating application software and testing operation, etc.)
- (2) Maintenance inspections, adjustments, and repairs
- (3) Technical instructions and technical training
- (4) Product tests or inspections specified by you

The above content assumes transactions and usage within your region. Please consult with an IDEC sales representative regarding transactions and usage outside of your region. Also, IDEC provides no guarantees whatsoever regarding IDEC products sold outside your region.

IDEC CORPORATION

Head Office 6-64, Nishi-Miyahara-2-Chome, Yodogawa-ku, Osaka 532-0004, Japan

USA IDEC Corporation
EMEA APEM SAS

Singapore IDEC Izumi Asia Pte. Ltd.
Thailand IDEC Asia (Thailand) Co., Ltd.
India IDEC Controls India Private Ltd.

China IDEC (Shanghai) Corporation
IDEC Izumi (H.K.) Co., Ltd.
Taiwan IDEC Taiwan Corporation

 www.idec.com

Japan IDEC Corporation

Specifications and other descriptions in this brochure are subject to change without notice.

2022 IDEC Corporation, All Rights Reserved.

