

Part Number: 16/30SB

Type	Size	Rating	Description
Neon	T6	AC	Standard Brightness Wire-ended Neon Lamp

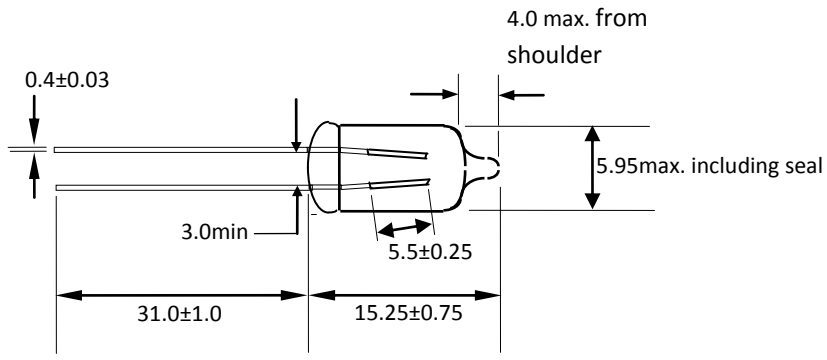

Dimensions in millimetres

Notes:

- | | | |
|---|------------------------------|-----------------------------|
| 1 | Brightness | Standard |
| 2 | Lead Type | Tin plated |
| 3 | Current | 0.5mA nominal |
| 4 | Strike Voltage | 65VAC maximum |
| 5 | Life | 50,000 hrs. nominal |
| 6 | Operating temperature | -50°C - +160°C |
| 7 | Environmental | RoHS & REACH SVHC compliant |