

Handwheels • DIN 950 cast iron

24580.0321

Product Description

Hub machined; rim turned and mirror-finished on all sides, non-machined surfaces cleanly blasted.

Material

Handwheel

- Cast iron GG

Machine handle DIN 98 EH 24460. rotating

- Steel, turned, zinc-plated by galvanization, passivated

Assembly

Shaft-end washers EH 22270. for axial fastening.

More information

Further products

- Shaft-End Washers
- Rotating Machine Handles, DIN 98



Drawing

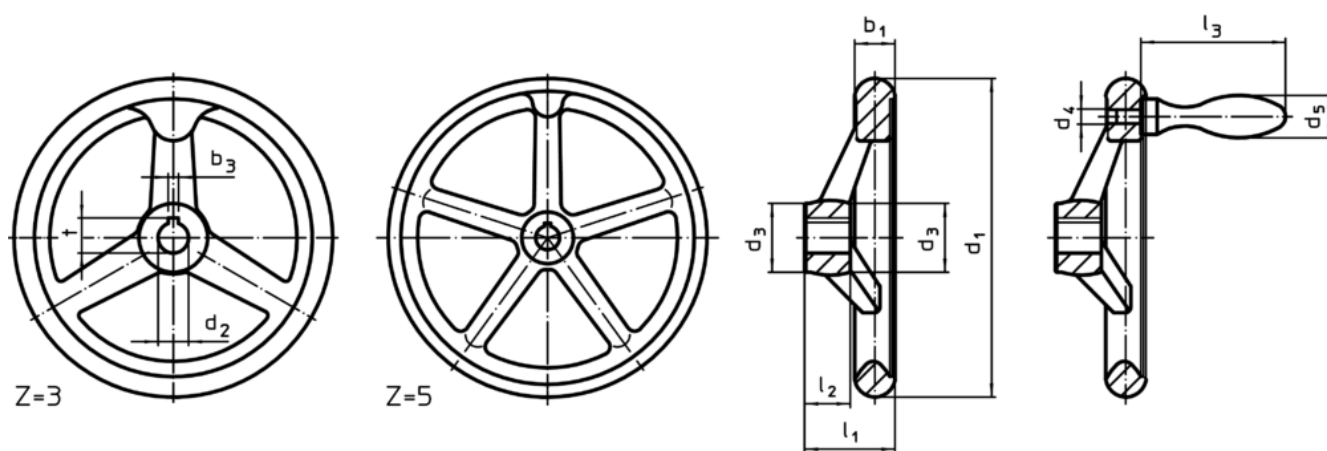

picture 1

picture 2

The orientation of the hub keyway may be different than shown in the drawing.

Order information

Dimensions								Hub keyway, DIN 6885 sheet 1		Number of spokes z	Corresponding machine handle DIN 39 / DIN 98	[g]	Art. No.
d ₁	d ₂ H7	d ₃	d ₄	d ₅	l ₁ ~	l ₂	l ₃ ~	b ₃	t				
with keyway, with rotating handle EH 24460. assembled, form N-F/G (formerly: D 3) – picture 2													
160	16	32	M10	25	40	20	75	5	18.3	3	25	1390	24580.0321

Application example



Compliance

RoHS compliant

Contains lead - compliant according to exceptions 6a / 6b / 6c

Contains SVHC substances >0,1% w/w

Contains lead - SVHC list [REACH] as of 10.06.2022

Contains Proposition 65 substances



Lead can cause cancer and reproductive harm from exposure
<https://www.P65Warnings.ca.gov/>

Free from Conflict Minerals

This product does not contain any substances designated as "conflict minerals" such as tantalum, tin, gold or tungsten from the Democratic Republic of Congo or adjacent countries.