

Face milling cutters, 45°

For SEET 12T3... indexable milling inserts

ORION[®]

Application:

For universal use in all materials, predestined for cast processing.

Execution:

- Nickel-plated supports
- Long-term tested support design
- Normal and fine pitch
- Clamping screw tightening torque (indexable insert) M3.5 = 3.9 Nm

Advantage:

- Highly positive indexable milling inserts for low-vibration, steady cutting
- Outstanding value for money

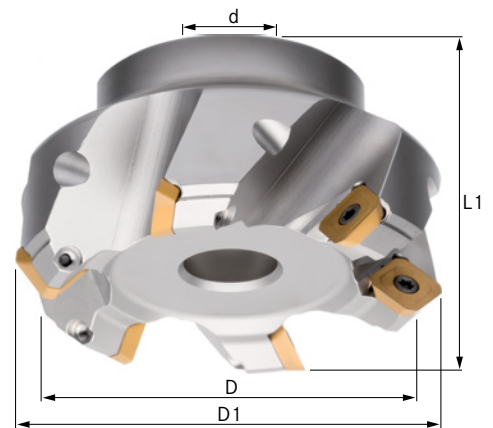

Art. no.	16003 200
Brand	ORION
Manufacturer Part Number	16003200
Min. cutting edge diameter	50 mm
Max. cutting edge diameter	61 mm
Length	40 mm
Bore diameter	22 mm
max. ap	6 mm
Number of cutting edges	3 PCS
Gross Weight	0.475 kg
Product Group	148

EAN

4039247532254

